

GUIDELINES FOR TEACHING  
**NUMERACY**

**FOUNDATION PHASE**

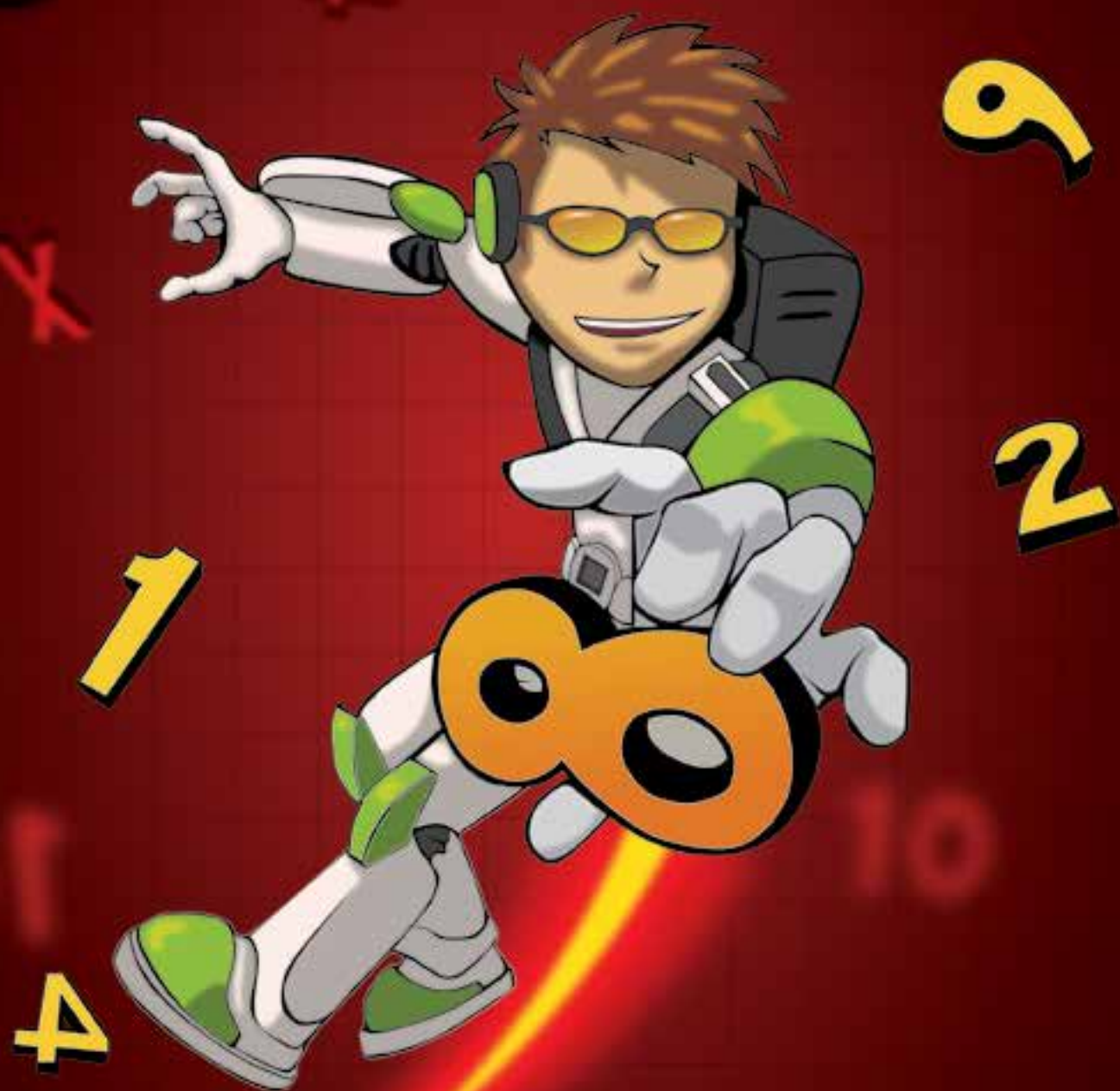

**KNOWLEDGE IS YOUR FUTURE**



# Contents

## Acknowledgements

<b>Introduction</b>	<b>1</b>
<b>Approach to learning and teaching mathematics</b>	<b>1</b>
<b>How the programme is organised</b>	<b>4</b>
1. Numbers, operations and relationships	6
2. Patterns, functions and algebra	9
3. Shape and space (Geometry)	12
4. Measurement	16
5. Data handling	18

## Suggested Activities to Promote Appropriate Skills and Knowledge

### Grade 1

1. Numbers, operations and relationships	20
2. Patterns, functions and algebra	48
3. Shape and Space (Geometry)	66
4. Measurement	78
5. Data handling	92

### Grade 2

1. Numbers, operations and relationships	100
2. Patterns, functions and algebra	140
3. Shape and Space (Geometry)	158
4. Measurement	180
5. Data handling	200

### Grade 3

1. Numbers, operations and relationships	208
2. Patterns, functions and algebra	248
3. Shape and Space (Geometry)	274
4. Measurement	316
5. Data handling	332

<b>Suggested Resources</b>	<b>343</b>
----------------------------	------------

## **Acknowledgements**

The Guidelines for Teaching Numeracy in the Foundation Phase was originally produced as support material for Foundation Phase educators in Gauteng, South Africa by COUNT for the Gauteng Education Department (GDE). This work, a digital version of the GDE publication of 2009, is released under the Creative Commons Attribution-Non-Commercial 3.0 licence. The materials have been updated so that they can be used by any educator teaching mathematics from Grades 1-3 in the primary years, in any country.

Guidelines for Teaching Numeracy in the Foundation Phase.

© Gauteng Department of Education 2009. Revised digital edition 2013

Authors: COUNT [www.countafrica.co.za](http://www.countafrica.co.za)

Citation: COUNT. (Rev. ed) (2013). Guidelines for Teaching Numeracy in the Foundation Phase. Johannesburg: Saide.





# Introduction

This programme provides Grade 1, 2 and 3 educators with:

- a progression of **appropriate activities** that introduce young learners to the basic mathematical understanding, knowledge and skills that they should develop during their early schooling;
- ideas and examples of **interesting practice activities** that will help learners consolidate and extend their understanding and skills;
- suggestions for **suitable interventions, support and challenges** to meet the needs of both struggling learners and learners who are ready to go ahead;
- ideas and examples of **resources** that educators can use to enrich and extend the activities at the end of each section, for each grade, you will find lists of possible resources you can use - at the end of the document you will find a Resources section which includes examples of worksheets and of materials you can copy for distribution to your learners;
- a discussion of the **approach to learning and teaching mathematics** that we adopt in this programme.

## Approach to learning and teaching of mathematics that underpins the programme

From the way many of us were taught mathematics, we may think that our job as mathematics educators is to **tell** or **show** learners **what** to do and **how** to do it in each mathematics situation. Whether or not our learners understand the methods we show them, we then expect them to “learn” mathematics by using the taught methods to complete a “mountain” of practice sums. So our learners come to think that there is only one correct, and often mysterious, way to solve mathematics problems.

Classroom research in many different countries shows that treating learners exclusively as “listen-and-practise” machines prevents many of them from becoming independent and competent mathematical thinkers who will be able to deal successfully with further mathematics education. On the other hand, the research shows that, when we adopt teaching approaches that encourage learners **to participate more actively and critically** in the learning process, they develop the confidence to:

- develop their own thinking, reasoning and solution methods;
- work with understanding;
- enjoy tackling different mathematical challenges.

This also applies to schools that have large classes and inadequate resources.

The activities in this programme employ various strategies to promote meaningful and enabling mathematical development. The strategies modelled in the programme include:

### 1. Using a variety of challenging and interesting problems

The programme helps learners to **give meaning to their maths experiences** by challenging them to investigate, discuss and apply their existing maths understanding to various **contextual problems**. The programme **varies the contexts, mathematical structure and level of difficulty of the problems** appropriately so that they are familiar, interesting and/or of practical value to young learners. We encourage educators to **give learners the time and the freedom to construct solution methods that best suit their levels of development and ways of working** in each situation.

When we do this, we find that learners:

- learn to think about the mathematics that is involved in various situations;
- are able to develop their own problem solving methods and choose which techniques and/or operations to use depending on their available number competence (e.g. counting in different ways, place value, ordering, comparing, building up and breaking down numbers, doubling and halving, using concrete materials lines);

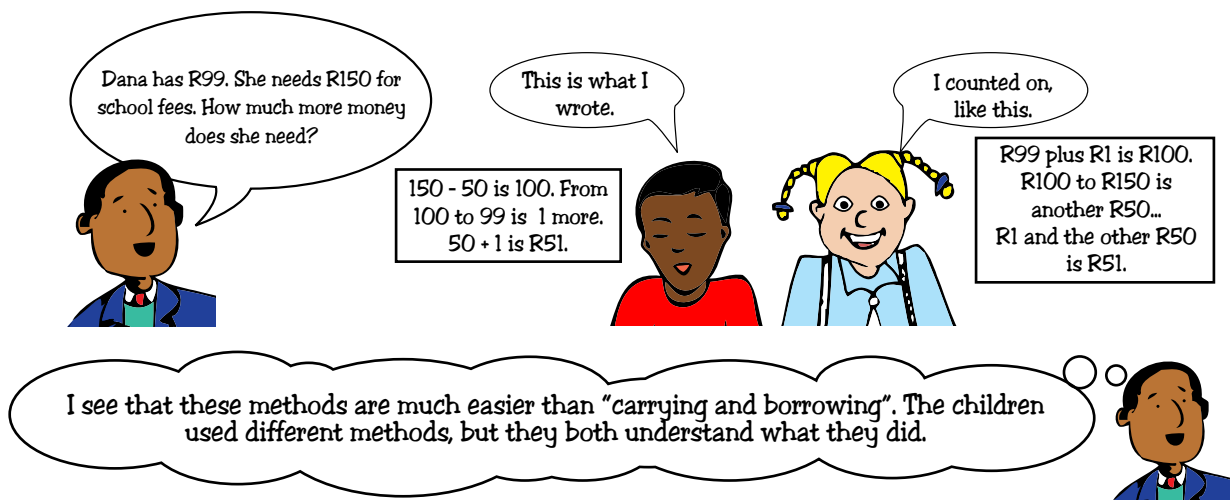

- are able to develop and use their own informal language and recording methods to help them solve, explain and justify their methods and answers;
- are able to develop and extend their own understanding of numbers and of how they can use them more efficiently to solve problems mentally and in writing.

## 2. Allowing learners to develop literacy skills to support their mathematical growth

In a problem-centred approach, learners' ability to understand the language (including the words, grammatical structures and contexts used) as well as their level of reading comprehension will obviously affect their progress.

The programme's example problems are described in simple language and include various types of contexts as we know that **language and mathematical skills develop** over time and **through repeated and varied learning opportunities**.

Educators will find that, depending on their learners' particular backgrounds and past experiences (including language experiences), they will respond with different levels of interest and understanding to different problems. We therefore encourage educators to think critically and work actively to increase the relevance of our programme by:

- treating the given examples as suggestions and varying them appropriately to meet the needs of your individual learners' circumstances;
- ensuring that you expose your learners to a variety of suitable contexts, mathematical concepts, skills and problem types;
- gradually introducing less familiar contexts as your learners' confidence and ability grows;
- paying special attention to the needs of learners whose home language differs from the language of instruction (for example, translating the materials or using code switching techniques);
- developing a classroom culture in which learners have many opportunities, and feel free to, experiment, ask questions, explain, share and test new ideas and ways of working with their peers and with their educator;
- helping learners become fluent with mathematical terms, symbols and conventions

by introducing them gradually and appropriately when you see that your learners understand and can use the underpinning maths concepts (see next section).

Research shows that, within this kind of supportive environment, learners functional literacy grows: Learners begin to read with more understanding and purpose and they learn to use their language and reading skills to extend their mathematical ability in ever broader contexts.

### 3. Helping learners to record their ideas in ways that they understand

The programme encourages educators to help learners translate their verbal explanations into written methods. As your learners find their own ways to solve problems, encourage them to record their methods in any way that makes sense to them. This helps them to clarify their thinking and keep track of what they do. Depending on their prior experiences, different learners will choose different recording methods in different situations and at different times. **At first**, they will probably do **rough drawings or jot down a few numbers, words and/or symbols**. It is important that educators value and promote these first informal written methods as **essential beginning steps towards the development of conceptual understanding**.

Let learners take turns to use their own language to share their ideas. (Remember that, for all of us, our most powerful thinking and learning language is our home language.) Encourage the rest of the group to listen carefully to check the solution methods. In the early stages, you can help learners by acting as their scribe. As you write their explanations, be sure to mirror closely what learners say – otherwise they will not understand what you are doing. Also ensure that you never encourage a learner to use someone else's method because it seems quicker or more sensible. With continued exposure and practice learners will begin to understand and adopt shorter mental and written methods.

When you feel that learners are ready, you can gradually introduce more abstract symbols. Mediate the links between what learners **do-and say** and what they **say-and-write** carefully and thoroughly. Learners will then begin to see that they can use mathematical words and symbols as short ways to express maths ideas that they already understand. Also make sure that **learners use the symbols correctly and with understanding**. Be sure to do so in a supportive, unthreatening and safe environment that promotes individual ways of doing things and welcomes mistakes as situations to learn from.

The advantages of working in this way are:

- learners become far more positive about mathematics;
- learners find that they can fall back on their own resources to discover number facts;
- learners find that they can re-discover number facts if they forget them;
- learners gain confidence to tackle new and complex problems in flexible ways;
- learners are able to add new facts to their memory banks – which they are more likely to remember because they have constructed them themselves.



## 4. Giving learners opportunities to share their experiences in small groups

The programme encourages educators to help learners develop their concept understanding and their language skills as they **work in small groups**. At times you may find it useful to let learners work in same-ability groups and at other times you may want to use mixed-ability groups.

As learners work you should:

- ensure that each learner feels confident to participate;
- ensure that groups can work independently and that they stay on task;
- observe the interactions within the groups, noting different ideas and ways of working that will contribute meaningfully to your whole classes' interest and development during whole class feedback sessions;
- where necessary, focus your attention on particular groups, either to support learners who are struggling or to promote and extend creative reasoning.

## 5. Use of appropriate resources

Resources and other concrete aids can contribute to the growth of mathematical thinking if they are used appropriately **to support learners as they construct their understanding of new concepts**. The programme provides many resource-based activities as well as examples of the resources which you can copy for your classroom use. ([See Resources](#)).

Remember, successful classroom use of resources depends on the educator:

- being familiar with the resources – so, if they are new to you, practise using them yourself in the given activities before you introduce them to your class;
- showing learners how to organise and manage the materials so that they are easy to use – for example, arranging their number cards systematically in rows and always replacing cards in their correct place after use;
- being able to assess when different learners are ready to move away from the concrete support and encouraging them to always feel free to do so.

## How the programme is organised

For convenience, the programme presents the work progressively for each grade under the following five headings:

### 1. Number operations

This section provides materials that help learners develop the ability to recognise, describe and represent numbers and their relationships, and to count estimate, calculate and check with competence and confidence in solving problems.

### 2. Patterns, functions and algebra

This section provides materials that help learners develop the ability to recognise, describe and represent patterns and relationships as well as to solve problems using algebraic language and skills

### 3. Shape and Space

This section provides materials that help learners develop the ability to recognise, describe and represent characteristics and relationships between two-dimensional shapes and three-dimensional objects in a variety of orientations and positions.

#### **4. Measurement**

This section provides materials that help learners develop the ability to use appropriate measuring units and formulae in a variety of contexts.

#### **5. Data Handling**

This section provides materials that help learners develop the ability to collect, summarise, display and critically analyse data in order to draw conclusions and make predictions, and to interpret and determine chance variation.

# 1. Numbers, operations and relationships

Having a good *sense of number* lays the foundation for almost all related numeracy skills.

We need to help our young learners to develop a sense of the size or ‘how muchness’ of a number – such that they know for example that 45 is larger than 40 and 450 is much larger. We need also to show them how we can break down numbers or decompose them and then re-build or recompose them in different ways. So 45 can be  $40 + 5$  or  $20 + 25$  or  $9 \times 5$  and so on. We also need to help them realise that there are many different computational strategies they can use or choose from to solve number problems.

Many young learners still use lines or stick figures to do calculations and solve problems. This shows that they have a poorly developed sense of number which impedes their further mathematical functioning and reasoning. Learners with a poorly developed number sense, will struggle to master higher order tasks expected of them in later years.

## Different levels of counting

In order to be able to assess the level of different learners’ estimating and counting skills you need to know about the **different developmental stages** that young learners tend to go through as they learn to count and combine groups of objects.

Have you ever watched how different learners go about solving a task like this?



You have 3 sweets and your mother gives you seven more.  
How many have you got altogether?  
You can use your counters to help you find out.

If you watch carefully, you will notice that different learners go about solving counting problems in different ways. We call these the different “Counting Stages”. Before you read on, think about whether you have noticed the different ways that learners, who have had different amounts of counting experience, may go about solving the problem.

## The Counting Stages

### Stage 1: Count all

Learners who are just beginning to develop counting skills, may struggle to put out the number of objects to match the numbers they need. If they count orally or count pictures of objects they will “count all” the objects one by one. They will probably guess inaccurately when they try to estimate.

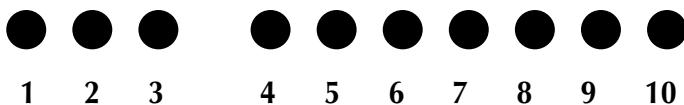



## Stage 2: Count on from the first number

Learners who have had more counting experience and guidance begin to base their estimates on their “sense” of the size of the total group. They also begin to understand that to find the actual amount they can simply “count on” from the first number, like this:

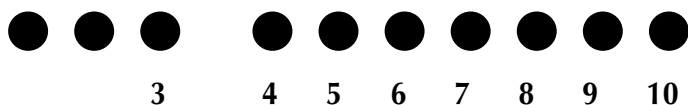

These learners have made a big “cognitive leap” (thinking step) in their understanding of number. They no longer have to count the smaller group to check that it is still three –they know it is three once they have put it out. In other words they have learnt to **conserve number**, or understand that the amount stays the same no matter how you arrange the objects to be counted (you will learn more about conserving numbers at a later stage).

## Stage 3: “Count on” from the biggest number

After still more counting experience, learners become more efficient counters. They realise that it is quicker **to start with the bigger number** (seven) and then just count on the additional smaller group of three counters. They can do this in their heads and do not need to re-arrange the counters. So they simply say something like this:

7            8            9            10

## Stage 4: Knowing from experience

Learners who have had lots of experience of putting amounts of numbers together in many different situations, **remember their number facts** and are able to apply them in different problem solving situations. So they may simply say something like, “3 sweets and 7 sweets makes 10 sweets altogether”.

## How do learners get there?

Here is an important question that educators must ask themselves in order to understand how they should plan and develop effective learning experiences for their learners:

How do we help young learners move through the stages from “counting all” to knowing their number facts and being able to use them meaningfully in different situations?

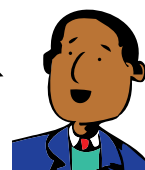

If we come from a rote learning schooling tradition we might think that to help a learner move from a “counting all” to a “counting on” stage we should simply tell them what to do. Maybe something like this:



No, no... don't recount all the counters. It is much quicker to just count on. Start from three and then say four, five, six, seven, eight, nine, ten. For the future, remember that 3 and 7 are ten. Practise after me... Three and seven are... three and seven are... Three and seven are... Next time I ask you about three plus seven I want you to be able to give me the correct answer immediately.

We become frustrated when many of our learners do not remember what we tell them. Even if they do remember when we simply ask, “three plus seven”, many of them do not understand that they can use the same number knowledge to answer



similar problems (for example a problem like, "I have three cents and mother gives me another seven cents. How much money do I have now?). They become even more confused when we change the way we structure the question, for example, "I have seven cents. I need ten cents to buy a sweet. How many more cents do I need to buy the sweet?"

Classroom based research in South Africa and other countries shows that, we cannot just tell them how to calculate or how to solve problems. We cannot *teach or tell* children to count on instead of counting all.

On the other hand, as long as we constantly expose them to objects that need to be counted, they will gradually come to understand that counting means adding on to or taking away from a given number. When they realise or "know" this, they will naturally drop "counting-all" methods and use quicker "counting-on" methods instead. In time they will be able to count forwards and backwards from any number without having to go back to 0 or 1. Learners need many different opportunities to count real objects and to match and compare them. In this way they can first build up ideas of "more", "less", "as many as" and then work towards more extended understanding of numbers.

When we introduce learners to new concepts and content, we should plan activities that will challenge them to work actively to find their own ways to get answers that they understand. We need to give learners time and opportunity to make sense of the world and to construct their own understanding.

We should aim to develop a variety of activities in a variety of situations that will help learners to work concretely in order to develop their own ways to understand the relationships between numbers. We should plan our learning activities to match our learners' levels of thinking. For young learners, who are in a "concrete operational stage", we should not jump too soon into abstract work with formal calculation methods and with symbols.

**Language** plays a central role in children's learning. Children need to speak and communicate in order to make contact with the world, so they must develop and use the tools (language) that make this possible. At first children just use language to label the environment and to establish contact with other people in their environment. Gradually, they become able to internalise language and use it internally for higher order thinking. So language is a tool that helps us to shape, develop and build our capacity to think.

**Play** also has a significant role in the development of thought and language. Children learn about their world through play and they use play to mediate and make sense of what they see around them. Learning can occur in many social situations that are mediated through language. Play, formal instruction, interaction with an older sibling, a parent, or another learner are all mediated through language. Through language, an experienced person can guide a learner's construction of ideas.

## 2. Patterns, functions and algebra

Even before they start school, young children develop concepts about patterns that help them to recognise trends and to organise their worlds. They learn repetitive songs and rhymes that are based on repeating and/or growing patterns. All around them they see shapes and colours arranged in regular ways to form patterns. Our African environment is particularly rich in these kinds of patterns – just think about our beautiful beadwork and the way many huts and homes are decorated. Young children may also see things in their environments that are beautiful, but do not follow any particular pattern. This helps them to distinguish repeating and predictable patterns from random arrangements of shape and colour.

Looking for patterns is a fundamental part of mathematics learning and a key part of developing mathematical thinking. This quote sums up the importance of why young children should study patterns:

*Looking for patterns trains the mind to search and discover the similarities that bind seemingly unrelated information together in a whole. A child who expects to make sense looks for the sense in things and from the sense develops understanding. A child who does not see patterns does not expect things to make sense and sees all events as discrete, separate and unrelated.*

Mary Brata-Lorton, quoted in Marilyn Burns: About Teaching Mathematics

### Patterns in our number system

The number system we use, called the Hindu-Arabic system, developed over thousands of years. Patterns form the basis of how our number system is structured. For example, we only use 10 symbols or digits, to write all numbers (0, 1, 2, 3, 4, 5, 6, 7, 8 and 9). The place where we write digits in numbers shows us the value of those digits.

Many teachers and learners alike regard number problems as a set of rules and steps to follow, where the goal is to mimic set procedures and come up with the right answer in a prescribed sequence of steps. Looking for patterns is not foregrounded or used as a strategy to help learners understand our number system, uncover number relationships or solve number related problems. If our learners are not helped to look for patterns as an approach to developing their understanding, learning and doing mathematics becomes more difficult than it should be. For example, when adding these sets of numbers together, a well-trained Grade 3 learner does this quickly, by looking for the value of the 1s digits that add to whole 10s.

$44 + 23 + 51 + 66 + 37 + 49$	She may re-write the numbers as:
$= 44 + 66 + 23 + 37 + 51 + 69$	and then combine the numbers in this way:
$= 100 + 10 + 50 + 10 + 110 + 10$	and now finds it easy to get the answer:
$= 110 + 60 + 120$	
$= 290$	

The necessary thinking skills take many years to develop and “learners should be given opportunities at every grade level to develop these skills to greater levels of sophistication so that they can be used with greater competence and confidence”. (South African National Curriculum Statement)

The mathematical skills involved, include:

- observing, recognising, analysing (finding ‘sameness’ and ‘differences’);
- specialising (becoming familiar with the details of each case);
- organising and representing - for example, you may put out counters or make a drawing to show what you think the fourth case will look like;
- using language to describe, explain, convince and justify conjectures (give reasons to support ideas);
- analyse, assess, agree with/argue and refute each others’ ideas;
- using patterns and relationships to predict and/or extend general rules to other patterns and relationships.

## Shape patterns

By introducing young learners to a variety of shape patterns, we can help them to find out about the geometric properties of different shapes as well as help them start to reason about patterns. Look for opportunities where your learners can find different shape patterns around the classroom - for example, in the structure of the window frames, the formation of the roof trusses, the paving or tiling on walls or floors, patterns used as borders of their workbooks, textbooks or in newspapers. Also set tasks where your learners can design their own patterns – for example stringing beads (e.g. one red, one blue, one green, or two yellow, one red, two yellow, one red ...) or laying out or drawing shapes in a patterned series.

These examples illustrate the kinds of patterns to focus on.

Learners should be able to identify the rule for the shape patterns, then draw the shape/s that they predict come next in the pattern and explain their reasoning. As they work, they analyse, represent and then internalise the properties of the each pattern. They also become aware of, and justify the rules they develop to describe the repeating or growing nature of the patterns.



In observing patterns, learners engage informally with concepts of transformation (change). They observe how the same shape is used in different orientations (directions) to create a repeating and predictable pattern. These kinds of patterns are abundant in art and craft. By using local examples, we can help learners come to appreciate the beauty and uncover the structure of patterns found in their own cultures. Note that in the beginning stages, young learners do not yet need to know the formal terms we use to describe these transformations: (the shape ‘rotates’ or ‘makes a turn’ of 90 degrees around its central axis). They should rather use their own ways to describe what they see – for example, “the shape turns this way or that way”.

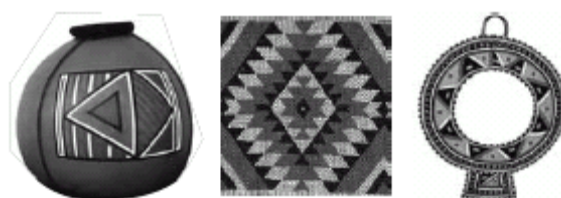

We can help learners to generalise rules for patterns by using prompts like:

“Describe the pattern?” ... “What are the next three shapes?” ... “How does the pattern go on and on? ...”

Embedded in both number and shape pattern investigations like these is the idea of a function. A function is a particular relationship between two sets of numbers (e.g. the position of a pattern and the number of shapes in that pattern). The notion of functions evolves from the investigation of patterns and underlies many mathematical concepts. Understanding functions makes it possible to predict results in problems in mathematics and many other applied learning situations.

### 3. Shape and space (Geometry)

In the past, most of us started work with shapes by simply telling learners the names of 'flat', or two-dimensional (2-D) shapes. We now realise that it is better to begin with real three-dimensional (3-D) objects because these are what we see most often in our everyday environments.

#### Three-dimensional shapes

We say that real objects are three dimensional because we can measure them in three 'dimensions' or directions. We can measure them from top to bottom (height), from side to side (width or breadth) and from front to back (depth). We can turn objects around and look at them from any of these three directions.

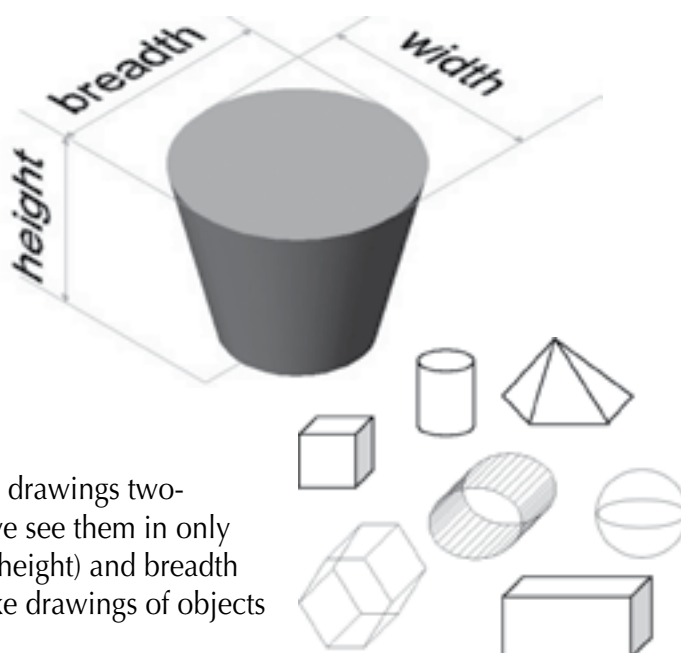

#### Two-dimensional shapes

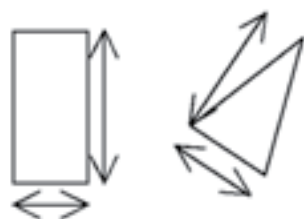

We call flat shapes and drawings two-dimensional because we see them in only two directions, length (height) and breadth (width). We cannot take drawings of objects off the paper.

We cannot actually draw a 3-D object on paper. We have to use certain conventions (agreed practices) to represent three dimensions on paper. Your eye tells you that these drawings are 3-D, but the drawings are actually flat. Young learners will see them as flat because they have not had experience of the 3-D objects that these drawings represent. Learners need to have many experiences with actual objects, and with linking these representations to the objects they represent.

As we learnt from the work of Piaget and others, children do a great deal of important spatial learning before they ever get to school. By observing and exploring, they learn to judge distances so that they can reach and grasp objects; they learn to negotiate their way through space; they learn how to fit shapes (including their own bodies) into spaces and they develop informal concepts about shapes.

So learners should start by handling real 3-D objects; blocks of different kinds, cones, balls to play and experiment with them. Through play, they can learn about the different shapes that make up different objects and the relationships of these shapes to each other.

#### The Van Hiele levels of geometric thinking

Pierre Van Hiele observed that children see and think about shapes differently as they develop. He identified five different levels of geometric thinking. If we understand and recognise these levels of thinking, we can begin to help learners develop through the different thinking levels.

1. The Van Hiele levels start with the **visual level**. During this level, young children use non-verbal reasoning, e.g. they learn to recognise faces before they can describe them and they learn to reach and grasp objects before they can say how far they need to stretch out. Children who are operating at this level will judge shapes by their whole appearance rather than by their attributes (e.g. number of sides, straightness of sides, number and size of angles). They use informal language to describe their visual impressions. For example:

"It's a square because it looks like one".

"It's a rectangle because it looks like a door".

2. During the next, **descriptive level**, children begin to learn to use language to describe the details of the **properties** of shapes. For example:

“It’s a triangle because it has three sides”.

However, at this level, they have not yet built up a set of logical rules about the shapes. For example, they cannot work out that, if a triangle has three equal sides, all its angles will be equal to each other. During this stage, if there hasn’t been enough correct guidance, learners use a combination of visual reasoning with their own unsophisticated, partial understanding of the properties of different shape categories. For example:

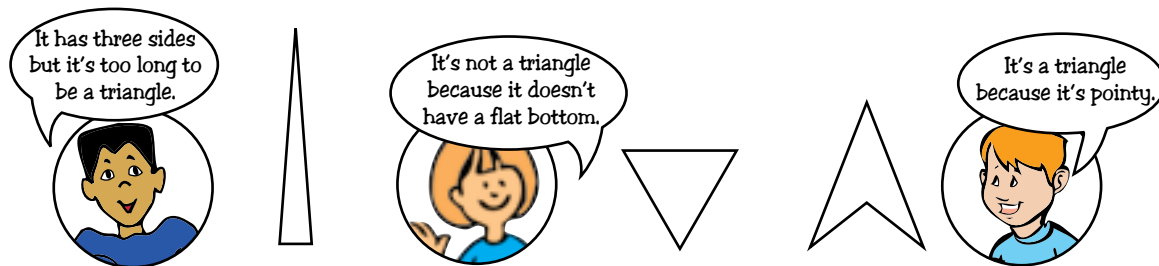

3. At the next level, the informal deduction level, learners begin to use reasoning to develop new ideas based on what they already know. For example, they can explain logically why squares are a special kind of rectangle.

Young learners do not need to know how to measure angles.

However, they can learn to use a corner of a piece of paper as a 'right-angle checker'.



I think that a square is a kind of a rectangle because it has 4 sides. The four angles of the four corners are all the same and the lengths of opposite sides are equal to each other.

4. During the next two levels, the **deductive** and the **axiomatic levels**, learners are able to reason in increasingly abstract ways. These levels are not generally suitable for young learners, although some current popular teaching methods expect learners to be able to reason like this. For example, they expect learners to understand the properties of prisms by merely giving them a few drawn examples with verbal definitions.

## What does this research suggest about teaching shape and space concepts?

Research shows that the development of learning from one level to another depends more on good and varied opportunities to learn than on physical or biological developmental. Many learners struggle with geometry in later years because they have not had enough appropriate early learning experiences to help them develop their thinking skills to the level of deductive reasoning.

So we must meet the challenge of leading our learners through a journey of discovery so that they can investigate the interesting and beautiful world of space and shape.

We must also meet the challenges that result from our own schooling where we were seldom exposed to working with space and shape in meaningful ways. Because we are now being asked to teach in ways that we were never taught, many of us are not confident about **what** to teach or **how** to teach it.

As with so much other mathematics learning, shape and space have been taught as a rote memory of shape names and properties. We need to change this and learn to create rich opportunities for learners to explore, to make connections, to construct, to discover, and to share and extend their existing knowledge.

Here are some more guidelines, based on research findings, that you should keep in mind when you develop and implement Shape and space activities:

- Children bring ideas about Shape and space from home.
- There can be big differences between various children's levels of spatial reasoning. For example, in one study, the educators found that one of their three-year-olds was able to identify and describe rectangles correctly while one of their six-year-olds thought that all 'pointy' shapes were rectangles.
- Maturity plays some part in the development of spatial sense. However, researchers conclude that, "Good opportunities to learn are more important than developmental level when it comes to children's learning about shape" (Douglas H. Clements and Julia Sarama).
- Reasoning and language ability grow when we encourage children to manipulate, explore and talk about what they do and see. As they investigate new concepts, learners need to work in 'hands-on' ways – handling concrete shapes and objects, moving them around, turning them over, and looking at them from different sides, angles and positions.
- To help learners develop their spatial sense, educators should, therefore, provide a wide range of materials and structure the physical and learning environments in ways that challenge children:
  - to explore and navigate through their environment;
  - to learn to mentally break up (analyse) objects and shapes into their parts;
  - to recognise and be able to explain what these parts are and how they are related;
  - to put the shapes and objects together again;
  - to extract the shapes embedded in the objects;
  - to use their understanding of the properties of shapes to compare objects and explain similarities and differences;
  - to build understanding of the links between real objects and the ways we represent them in drawings and diagrams (e.g. drawing something small to show that it is further away).
- We also need to challenge learners to learn to work independently:
  - to make conjectures ("this is what I think") about shape and space relationships;
  - to verbalise, describe and explain their choices and reasons;
  - to create chains of reasoning;
  - to find different ways to approach and solve problems;
  - to search for ways to prove or disprove these ideas.
- As with other mathematical ideas, during the early stages, learners should use their own informal language ('pointy', 'fat', and 'long', 'up high'). As their concepts grow, educators should model and scaffold in the correct mathematical language to help learners clarify, communicate, summarise and generalise their spatial ideas.



- We need to allow a great deal of time for young learners to work through all these learning processes.

Pierre Van Hiele suggests the following sequence of learning activities to prepare learners for success, enjoyment and confidence with Shape and space:

1. Start with a discovery stage during which learners explore and manipulate the materials in their environment.
2. Gradually build up concepts and language by helping learners to focus on the details and inter- relationships.
3. Present summary activities that help learners use what they already know to build new ideas.

## 4. Measurement

### Time

Because our modern lives are so strongly regulated by clocks and calendars, we tend to take the measurement of time - in years, months, weeks, days, hours, minutes, and seconds - for granted. We forget that the tools we use today are the product of thousands of years of cultural development. It is important, though, to understand that the concept of time is complex for young children. In other areas of measurement, learners start by comparing two things directly e.g. is the blue block longer, shorter, or the same length as the red one? Does the tall thin bottle hold the same, more, or less than the short wide bottle? The learner compares the quantities directly, and if she is unsure, she goes back and compares again. But time, by its very nature, is transient (it passes quickly), which means there are fewer opportunities to make direct comparisons.

Time is one of the most mysterious quantities that can be measured – not only for children, but also for adults, even for scientists and mathematicians. Other quantities we learn to measure in school are comparatively well behaved. Time, though, twists in a complex spiral of many cycles without ever passing a given point more than once. Our experience of time is also highly subjective. For children, as for adults, when waiting for a special event each moment may seem like an eternity, while an hour spent playing a game, climbing a tree, or daydreaming may seem to pass in an instant.

There are three distinct aspects of time for the young learner to grasp:

- **Sequencing**, or ordering events in time, has to do with the linear nature (passing) of time. It involves words like *before*, *after*, *first*, *second*, *next*, *last*, *yesterday*, *today*, *tomorrow*, *before*, *after*, and *now*.
- **Duration** is the 'how muchness' of time, and uses words like *long*, *short*, *quick*, *fast*, *faster*, *slow*, *slower*, *how long ago*, *how long will it be*, *how long will it take*, as well as units of time such as *hours*, *minutes*, and *seconds*, *days*, *weeks*, *months*, *years*.
- These terms are also used in **Calendar time**, which has to do with the cyclic nature of time. The vocabulary of calendar time reflects these many cycles – *day*, *week*, *month*, *year*, *season*, *morning*, *afternoon*, *evening*, *night*, *midnight*, *weekend*, *today*, *spring*, *summer*, *autumn*, and *winter*, as well as the days of the week and the months of the year.

### Mass, length and capacity

Learners' first experiences in measurement involve making direct comparisons e.g. which block is longer? These concrete experiences are important for learners to identify measurable properties of objects. The goal of early lessons in measurement is not simply to teach the mechanics of measurement, but rather to develop measurement reasoning in learners. This reasoning allows learners to compare attributes even when direct comparison is not possible. Researchers have found two distinct cognitive levels – *transitive thinking* and *unit iteration*, and have observed that transitive thinking always comes before unit iteration.

**Transitive thinking:** Transitive thinking is the ability to connect two or more different relationships. For example, the young child can immediately see from these pictures that A is longer than B, and that B is longer than C. But if the first picture is on one desk and the second is on another desk, when asked which is longer, A or C, some learners may struggle, because they cannot compare A and C directly. When learners have developed transitive thinking, they will be able to reason that, if B is longer than C, then something which is even longer than B will also be longer than C.

**Unit Iteration:** Only after transitive thinking has developed, does the learner develop unit iteration.

Unit iteration means the ability to correctly repeat a unit a number of times, without gaps or overlaps, to measure something longer than the unit used. Unit iteration involves making a mental relationship between the parts and the whole, between the unit used for measuring and the length measured.

Measuring again and again, whether with standard or non-standard units, does not provide learners with enough understanding to develop transitive thinking and unit iteration. Learners need experiences that challenge them to think in order to develop measurement reasoning.

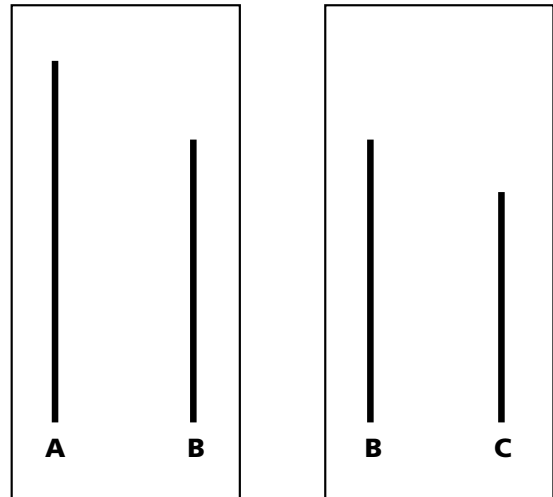

## 5: Data Handling

Citizens in a democracy must make a myriad of decisions, and the health of the nation depends upon those decisions being wisely taken.

There is a wealth of data to help us make these decisions, and it bombards us from every direction - television, newspapers and other media - inflations, stock market prices, crime rates, rainfall, sports results, election polls, government spending, population and health statistics. Through the study of data handling, the learner develops the skills to collect, organise, display, analyse and interpret this information in systematic ways. They can then go on to draw conclusions and make predictions based on the data. This enables the learner to participate meaningfully in political, social, scientific, cultural, and economic activities.

By studying data handling, the learner will also understand how data can be used either to faithfully represent, or to misrepresent a situation, and how to tell the difference.

In the beginning the teaching and learning of data handling focuses on sorting objects and data in different ways, based on the different features of the objects or data. The learner should be able to represent data in different forms that involve a one-to-one correspondence between items in the data set and their representation. For each grade in the programme there is a summary of the forms of representation that are appropriate for learners in that grade.

There are some probability and combination concepts and experiences that will prepare young learners for the study of probability when they encounter it in later grades.

- Learners should understand the concepts of certainly, not possibly, probably, likely, unlikely, etc.
- How likely is it that it will rain tomorrow? What is the chance that the sun will rise tomorrow?
- Learners should have a lot of experience with random events by playing games with dice and spinners.
- Your number lessons should include problems involving combinations, such as, "If four teams are playing in a league and each team has to play each other team once, how many games will be played in all?"



# Grade 1: Numbers, operations and relationships

The learner will be able to recognise, describe and represent numbers and their relationships, and to count, estimate, calculate and check with competence and confidence in solving problems.

## Skills and knowledge

### The learner:

- Counts to at least 34 everyday objects reliably.
- Knows and reads number symbols from 1 to at least 100 and writes number names from 1 to at least 34.

The vocabulary that learners need to understand and use for these skills is listed at the end of the suggested activities. You will find it helpful to make flash cards with key vocabulary words to support the teaching and learning process. A list of the resources you will need for the activities is also provided. (See Resources)

## Suggested activities

### Counting concrete objects: building number sense

To help learners build a sense of the 'how muchness' (numerosity) of each number, give them many opportunities to count out different objects in and around their classroom. Depending on their previous experiences with concrete counting, different learners will be able to count correctly to different amounts. So it is best to allow learners to count up as far as they can go, rather than deciding beforehand on a fixed amount for the whole group each day. Start with amounts that learners understand and gradually introduce bigger amounts as learners show that they understand the relative size of the numbers.

As learners work, you should ask guiding questions to help them develop the following important concepts and skills:

#### 1. Attach the correct number names to groups of objects

##### Link the number words with the objects

We call this establishing **one-to-one correspondence** between the number of objects and their number names. When they start counting, many young learners simply say the number words in sequence as they point to objects at random. They may not know when to stop 'counting' and 'count' the same object more than once, or they may miss some objects out completely. Encourage learners to *organise* their objects to be counted (for example by, moving each object to one side as they count it, or, particularly with bigger numbers, by organising them in groups or in rows). It is then easier to count and name each object only once.

At first some young learners think that the purpose of counting is simply to say the number sequence as they point to the objects. When you ask them, "How many are there?", they may simply count the objects again. It takes time and many different experiences for them to understand that the answer

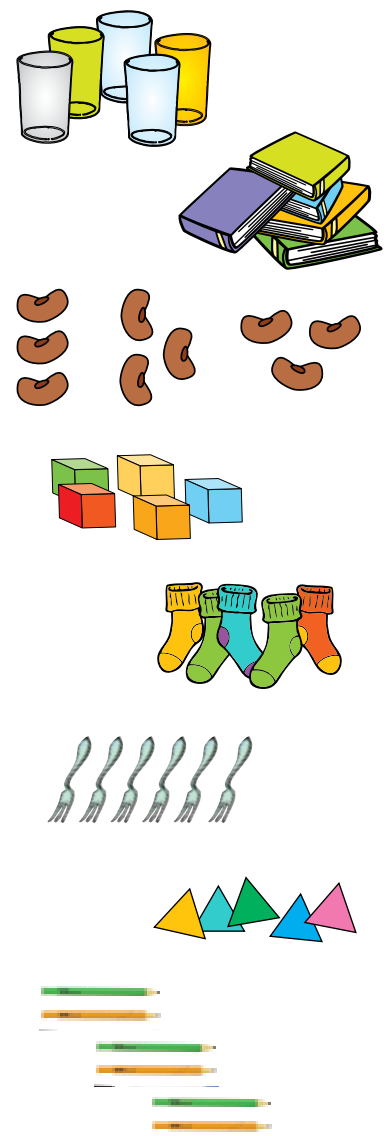

# Grade 1: Numbers, operations and relationships

to this question is the last number name they said. So always ask them “How many” and, where necessary, model the answer or, better still, get other learners to do so.

Include questions and activities to introduce the *concept of zero* (or ‘none’, ‘no more’), e.g. “How many tails does Mpho have?” ... “How many bottle tops on your table?” (before they take out their counters)... “You have six sandwiches. How many more do you need so that six children can have one sandwich each?”

To check that learners are developing a sense of the size of the numbers they are counting, let them *estimate* the number of objects in groups before they count them. They can then check their estimates by counting.

## Different groups, same number

Learners need to understand that, even if groups with the same number of objects look very different (e.g. three beads, three leaves, three doors) they have their numerosity in common – in this example, their ‘threeness’.

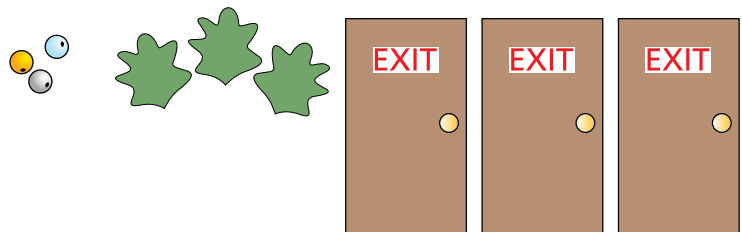

## Different arrangements, same number

Learners need to understand that, if we rearrange the objects in the group, the total remains the same. To help learners build this understanding, put out groups of the same number of objects (at first, use the same objects for each group, later use different objects for each group). Ask learners to say what is the same about these groups.

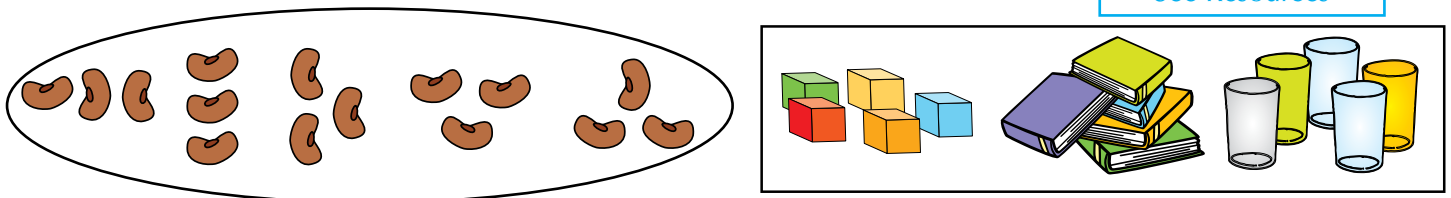

You can also put out groups with different numbers of objects. Ask learners to match the groups that have the same number of objects.



Later, once learners have learnt to recognise number symbols, they can label each group with the correct number label or card.





# Grade 1: Numbers, operations and relationships

## Building up and breaking down

Learners need to find out, when we break groups of objects into parts in different ways, their totals remain the same.

Once learners have developed stable ideas of the 'how muchness' of particular numbers, let them explore different ways to **build up and break down these numbers**. For example, give groups of learners 5 glasses. Let them find as many different ways as they can to break their group of 5 glasses into sub-groups. They can use number cards to label their sub-groups and their totals. Later, they can label their sub-groups and totals with the appropriate number symbols.

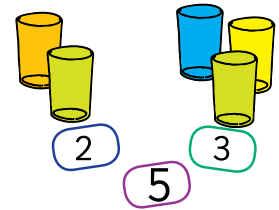

Learners can use their number cards to build up collections of all the different ways they found to break up particular numbers. Encourage learners from different groups to study each other's displays and to add additional possible combinations that they may have missed. Allowing learners to repeat this type of activity with each number in turn will help them to discover the relationships between numbers. They will also learn their number bonds more effectively than if they are simply required to repeat them by rote or to do quick recall of number bonds fired at them during mental maths sessions.

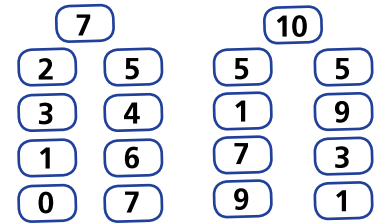

Learners can then make written copies of their displays. They can also develop and practise various other ways to build up and break down numbers and to record what they do.

Let learners choose a number and see how many different ways they can find to break it up, for example:

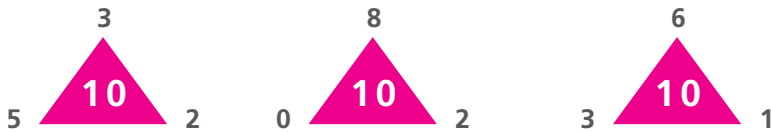

You can change and/or extend this format by writing some of the outside numbers and letting learners fill in the missing numbers.

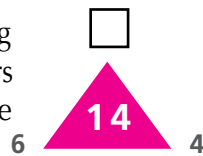

Later, once your learners have learnt how to write number sentences, you can show them how to link this format to the 'empty box' format.

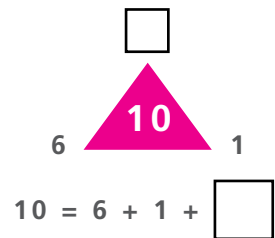

You can also use other outline shapes with more sides to encourage learners to break numbers into more parts.

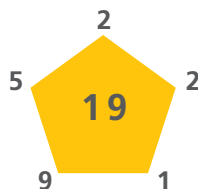

Extend these activities by putting out a group of, say, 3 objects and another group of, say, 5 objects. Ask learners to find out what they must do to make the number of objects in the two groups the same. Or pose other challenging problems. Ask learners to find and explain their own ways to solve the different problems and to check their peers' ways of working.



You put out 3 glasses, but there are 5 children in your group. How many more glasses must you put out?



I drew in 2 more glasses to make 5.



I counted on my fingers from 3...4...5. That's 2 more.



I added on 4 and 5, that's 2 more.

# Grade 1: Numbers, operations and relationships

## Find the correct number of objects

Learners must be able to count out given amounts of objects (increase the number range gradually as learners develop understanding).

For example, ask learners to:

- Show me eight fingers.
- Show me nine matchsticks.
- Put out, or draw, counters to show how many people there are in your family.
- Hold up a number symbol, e.g. 7. Ask learners to read the number and get themselves into groups of 7.
- Show me the parts on your body that you have altogether: one nose, two eyes' ten ...
- You have 3 spoons, there are 10 learners in the group. Show me how many more spoons you need so that each learner has one.
- Use egg boxes. Write a different number in each segment of the box in the range that learners are working on. Learners must put the correct number of counters into each segment.



You will notice that before learners develop stable concepts of the size of the numbers, they need to point to and 'count all' the objects one by one over and over again. During this stage learners will also probably guess wildly and inaccurately when you ask them to estimate how many they should put out.

With more counting experience and guidance learners begin to base their estimates on their 'sense' of the size of the total group. They also realise that they can find the total of two groups by 'counting on' from the first number. They no longer need to recount the first group. Once they have put a group of 3 objects out they 'know' it is three. We say that they have learnt to **conserve number**.

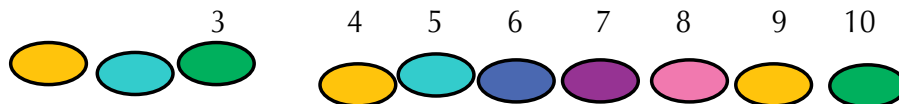

It is not helpful to teach or tell learners to count on instead of counting all. As long as we constantly exposed them to objects that need to be counted, they will gradually realise that counting means adding onto or taking away from a given number. When they 'know' this, and have built up a sense of the numerosity ('how-muchness') of the numbers they are working with, they will naturally drop 'counting-all' methods and use quicker 'counting-on' methods. In time they will be able to count forwards and backwards from any number without having to go back to 0 or to 1. Note that, depending on their past experience, learners may be at a 'count-on' stage for small numbers but may still need to 'count all' when they work with bigger numbers for which they have not yet built up stable concepts.

## 2. Counting actions

To build up learners' 'body sense' of the size of numbers, link the counting of actual objects to 'action counting'. For example, ask learners to:

- jump, clap or nod 4 times;
- nod 3 times, then nod 4 times more;
- bounce the ball 10 times;
- count how many times I bounce the ball.

## Grade 1: Numbers, operations and relationships

- Do rhythmic counting with actions in a sequence (nod your head twice, stamp your feet 3 times, or click your fingers 5 times, or tap on the table 4 times).
- Make up their own sequence of actions, let the rest of the class watch, listen and then describe the sequence they see and hear (they can also do this with closed eyes – good counting activity for visually impaired learners).
- Count the number of handspans, footsteps etc. to measure various objects in and around the class.



### 3. Counting objects in pictures

As learners build their number sense, let them begin to work more abstractly by counting pictures of objects and by representing given numbers of objects in drawings.

- Start by letting learners count realistic drawings on worksheets, work cards, transparencies and in textbooks. Remember to provide examples where the objects to be counted are arranged in different ways so that you encourage learners to count the objects rather than respond to a fixed visual impression.
- Increase the number of objects in the pictures as learners' counting skills increase. Some learners will want to use the patterns they uncover in our counting system to count on beyond 34. Encourage them to do so.
- Later, learners can do the same counting activities with dot patterns. Make a series of differently arranged dot patterns for each number in the range that learners are working with.
- At different times set different activities with the cards, for example: Give learners a set of the same number (e.g. a set of 8s). Let them count and label the subgroups and the total.

See Resources, p346, for examples you can copy for your learners.

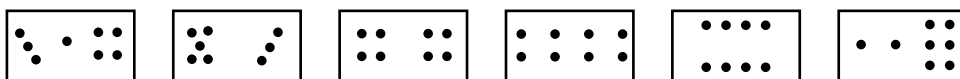
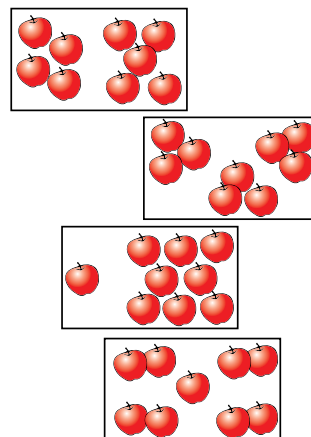

See Resources, p348, for examples you can copy.

- Give learners a set of different numbers. Let learners match the cards that have the same number of dots. They can also label the dots.
- Let learners place a set of cards with different numbers in order from smallest to biggest or from biggest to smallest.
- Ask learners to find cards that will *double* or *halve* a given number.

### 4. Recording amounts

- Let learners find their own ways to represent amounts, first with rough drawings of the objects e.g. "Draw the girls in your group," and later more abstractly by drawing a line or dot on a slate or piece of paper to show each object they count.
- Let learners represent their methods and solutions to different mental and written calculation problems with drawings. As they gain confidence they will want to use shorter, more abstract methods to show what they do, e.g. with dots or lines to represent amounts. They must explain their own drawings and check their own and peers' solutions.
- Introduce number cards to help learners label numbers as they count. The cards are particularly useful for helping learners understand how we combine different values to read and write numbers beyond ten.

Make cardboard cut-outs of the tens and units number cards for each of your learners. (See Resources, p344).



## Grade 1: Numbers, operations and relationships

Teach learners how to arrange their cards in order so that they can find and replace each card easily. Learners can work in pairs. Challenge them to find and explain ways to build 2-digit numbers. Let them write the number in parts, and as a single number (e.g.  $20 + 6 = 26$ ). If you teach in a language like English, start with numbers in the 20s and 30s because the patterns are easier to understand than in the numbers from 11 to 19.

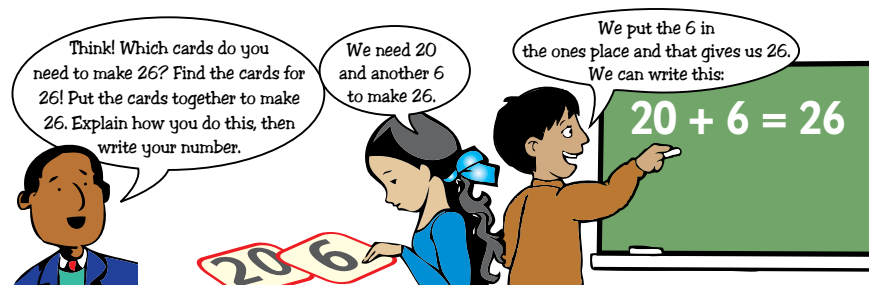

When you work with numbers from 11 to 19, help learners to understand that, for example, 'seventeen' means ten plus 7.

Number cards are especially useful for developing understanding of '11'. Learners can see that the two ones show different amounts because we *place* them in different positions in the number.



As they become ready, encourage learners to replace concrete drawings with symbols and operation signs to show their methods and solutions.

As learners are exposed to number symbols to label amounts and put them in sequence, e.g. on number charts, tracks and lines, they will begin to recognise them and connect them to the correct amounts. Many learners will also begin to copy the symbols on their own.

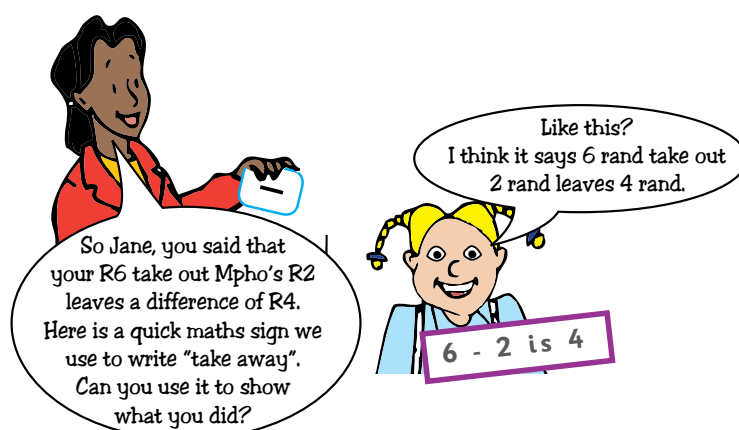

Accept their informal efforts during maths lessons and, at the same time, help learners learn to form each number in turn correctly and clearly through the following activities:

- Learners trace big numbers, and later smaller ones. Reinforce the sensory feedback from number tracing by letting learners trace along sandpaper cut-outs or dotted patterns of the number symbols.
- Learners write numbers in sand, in square blocks where, as necessary, you provide dots to indicate the starting, ending and some in-between points of the symbols. Help learners who struggle to develop 'self-instruction sequences' to guide them through the movements they must make as they write each symbol, e.g. "To write a one, I start at the top and go straight down... To write a seven, I start at the starting point, go straight across the block and then I come down on a slopy slide to the end dot".

## Skills and knowledge

### The learner:

- Counts forwards and backwards in ones from any number between 0 and 100.
- Knows and reads number symbols from 1 to at least 100 and writes number names from 1 to at least 34.
- Orders, describes and compares whole numbers to at least 2-digit numbers.

The work you do with counting, ordering and comparing numbers must go hand in hand with the work you do to help learners establish knowledge of the size of different numbers.

As learners count out different objects they will learn to say the number sequences and to count larger and larger numbers. *Start with activities to help them build understanding that each number in the sequence is one bigger than the previous number and one smaller than the next number.* Remember to start by linking the work to concrete objects. Daily rote oral counting may help learners to learn to 'sing' the numbers in sequence, but it has no value if learners do not understand the relationship between the number names and the relative amounts that different numbers stand for.

## Suggested activities

### 1. Develop the concepts and vocabulary of comparison

In many different concrete situations, help learners develop and use words to describe comparisons e.g. more, less, fewer, as much as, a little, a lot, same, different, equal, about, nearly.

For example learners:

- Compare different aspects of themselves, e.g. Who is the tallest? Who weighs more? Who is the oldest?
- Trace outlines of each other's bodies as they lie on large pieces of paper, cut the outlines out and order them from biggest to smallest.
- Compare objects, e.g. Which container holds the most? Which weighs more?
- Compare groups, e.g. ask one learner to find enough friends to make a group of five, another learner to form a group of three with friends, another to form a group of four, etc. Let the groups stand in rows. Learners must compare the rows and then order them in ascending and descending order. Ask questions like: "What is different about the row of three and the row of four? Which row has one less than the row with five?... two less?"

Vary the game by asking learners: "Form a group of one. Now form a group that has one more. How many in the new group?... one more... etc." or "Form a group of five... now form another group that has one (or two less)" etc.

Later you can extend the game by letting learners use counters, e.g. "Put out three counters. Now put out one more. How many are there now?... Put down five counters. Take away one. How many are there now?"

### 2. Make ordered groups of objects

- To help learners see how the numbers grow by one each time, let them put out the corresponding number of objects under a sequence of number cards. Start with small sequences and increase the sequence size and range as learners' number knowledge develops.
- Use egg boxes. Write different numbers in sequence in each segment of the box. Learners must put the correct number of counters into each segment.

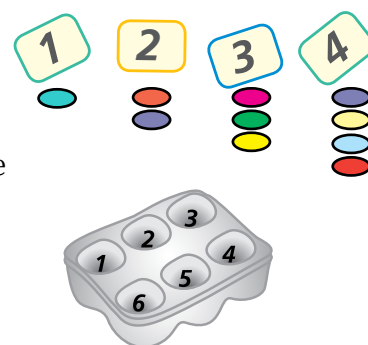



## Grade 1: Numbers, operations and relationships

- When learners start working with numbers beyond ten, let them use their number cards to label the number sequence.

20

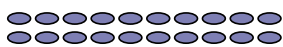

21

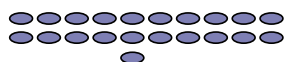

22

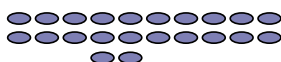

23



### 3. Songs, rhymes and stories

Introduce number and counting songs, rhymes and stories to reinforce counting sequences. Let learners illustrate the number concepts through actions. Ask questions that challenge learners to think about the number sequences and patterns, e.g. In the elephant song below, “Six elephants balancing, you choose one more elephant. How many elephants balancing now?”

One little elephant balancing, Step by step on a piece of string ...

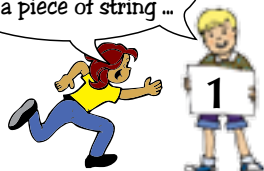

One little elephant balancing,  
Step by step on a piece of string,  
Thought it such a jolly stunt,  
Called up another little elephant,  
Two little elephants balancing,  
Step by step on a piece of string,  
Thought it such a jolly stunt,  
Called up another little elephant,  
Three little elephants balancing... etc., ...  
Four, five, six elephants balancing, ...  
All of a sudden the piece of string broke.  
And down fell all the little elephants.

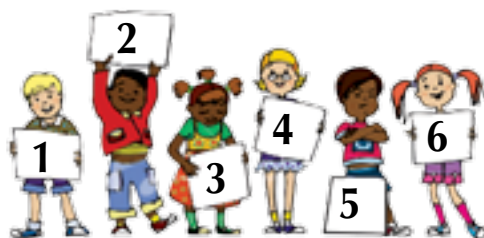

#### Link to ordinal numbers

- As learners work on different activities, introduce the vocabulary of ordinal numbers by asking questions like: “Who was the first elephant? How many counters must you put under your first number card?... under the second number card? ... under the third number card,” etc.
- Let learners stand in a row. Ask: “Who is standing in the first place? ... in the eighth place?... In which place is Thandi standing? ... Will the person standing in the fifth place please hop up and down five times ... Will the person in the twentieth place hop up and down 20 times!”
- Give each learner a card with a different number. They must arrange themselves in order according to the numbers on their cards. Let them arrange themselves in both ascending order (from the smallest number to the biggest number) and in descending order (from biggest to smallest).

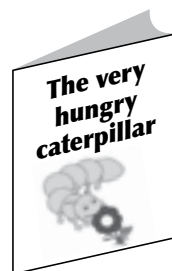

By Eric Carle

### 4. Practical ordering and comparing of sequences

#### Tower game

Play the Tower game to help learners match, compare, order and label amounts. Use dice, unifix cubes and number cards. Learners take turns to roll the dice.

They count out the number of cubes that the dice shows. They build a tower with their cubes and choose number cards to show how many blocks there are in their tower. After about three turns, ask learners to order their own towers and describe what they see.

My tallest tower has six blocks. My shortest one has two blocks and the one in the middle has 4 blocks. I put my towers in order from smallest to biggest.

My tallest tower has only 5 blocks, my middle one has 4 blocks. My shortest one has only 1 block. Mine go from biggest to smallest.

John, you have a 5 tower, a 4 tower and a 1 tower. Which two towers can you build between your 4 tower and your 1 tower so that your towers still go from biggest to smallest? Say what you think, then build the towers to check.

# Grade 1: Numbers, operations and relationships

Ask guiding questions that encourage learners to use words like 'first', 'second', 'last' to describe and compare their different arrangements and to complete the sequences.

## Ordering groups

Put out groups with different numbers of objects. Ask learners to find the number in each group (they can use number cards to label them) and then order the groups in ascending and descending order.

## Calendars

Let learners find their birthdays on calendars. Ask questions like: "On which day of the month is your birthday? ... Whose birthday comes first this month? ... Can you place yourselves in order, from the person whose birthday comes first in the month to the person whose birthday comes last in the month?"

## 5. Number boards and number charts

Number boards and number charts are useful aids to help learners build links between the numerosity and the sequencing patterns in our number system. For example:

You can make copies of the top part of the Number board in Resources, p 361.

Let learners put counters out, one by one, on number boards as they count forwards and backwards. This will help them develop a sense of the actual size of the numbers and also give them practical experience to help them see that there is one difference between the adjacent (next to each other) numbers in the counting sequence (one more going forwards and one less going backwards).

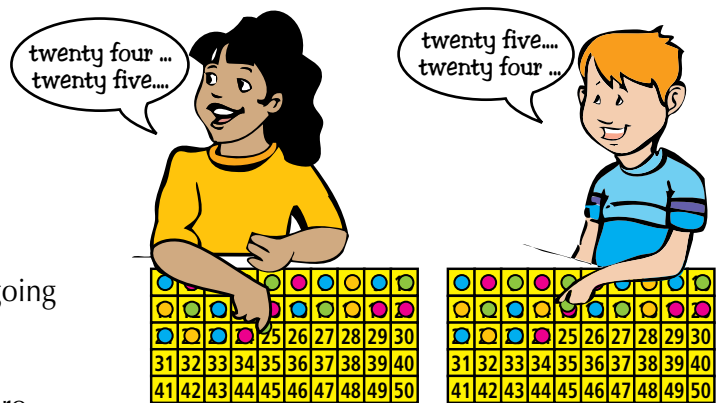

For counting forwards, let learners start from zero.

## 6. Number tracks and number lines

Start with number tracks, which are more concrete and understandable than number lines. In the playground, let learners start by counting as they jump forwards and backwards on a big track marked with familiar numbers. At a later stage you can let your learners 'jump' a counter forwards and backwards on a smaller track. Play games that challenge learners to predict and check where they will land with different sized 'hops'.

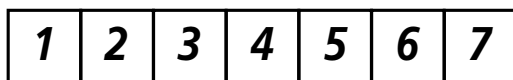

Put 6 counters on your board. How many more counters do you think you must put out to get to 10? Check your estimate by putting out counters till you get to 10.

Put out 18 counters. Estimate and check. What must you do so that you have only 15 counters on your board? ... Which numbers come between 15 and 18... Which number comes before 18? ... after 18?

You said you put your counter on 7 then jumped back 3. You landed on 4. This is how you can show what you did. Each arrow shows one jump backwards.

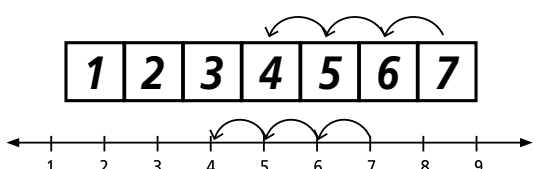

You start on 3 and jump 1 forward. Where will you land? You start on 6 and jump 6 backward. Where will you land?





## Work it Out

Say: "Work out the secret number I am thinking about. My number is more than 10 but less than 12 ... My number is an even number between 17 and 20 ... My number is double of 7... My number is one bigger than half of 30." Let learners make up their own secret numbers for their friends to work out. You can first link these to number lines or number boards. As learners develop confidence, let them work abstractly.

## 7. Writing number sequences

As learners gain confidence and experience with the links between the numerosity and sequencing patterns of increasingly big numbers, let them work more abstractly to show sequences and patterns in writing.

- Learners fill in missing numbers on number boards or charts.
- Learners fill in missing numbers on a number line, a picture of a ruler or of a scale.
- Learners complete forward and backward number sequences, starting from any number within the range that they are working, e.g.

1; 2; \_\_\_; 4; 5; \_\_\_; \_\_\_; \_\_\_; 9; \_\_\_; \_\_\_

21; 20; 19; \_\_\_; 17; 16; 15; \_\_\_; \_\_\_; \_\_\_; 11; \_\_\_; \_\_\_

Later, once learners have learnt how to use the addition and subtraction symbols, you can extend the written sequences like this:

3  $\boxed{+1}$   $\rightarrow$  4  $\boxed{+1}$   $\rightarrow$  \_\_\_  $\boxed{+1}$   $\rightarrow$  6

- Learners connect a series of numbered dots in the correct order to form a picture or a shape.

## 8. Sequence activities

- Integrate with data work. Let learners sort, describe, compare and order data collected for pictographs, e.g. learners order themselves according to their ages, or they order the months of the year according to the number of children/boys/girls who have their birthdays in that month.
- Integrate with informal measurement activities, e.g. learners count the number of footsteps or strides they take to cover a given distance. They compare the number of footsteps taken by bigger and smaller children and then order the numbers from most to least or from least to most. Challenge them to uncover the patterns in the numbers, e.g. "The bigger the child's foot, the fewer footsteps she takes to cover the distance".
- Once learners have learned the value of different coins and notes, they describe, order and compare them. Extend the activity by giving them groups of coins and asking them to order the total amounts of money from biggest to smallest. Learners must explain their solutions.

1	2		4	5		7	8	9	10
11		13	14	15	16		18	19	20
21	22	23	24		26	27	28		30
31		33	34		36	37		39	40

Use the blank number board, Resources p360.



See Resources, p356 - 357, for examples you can copy for your learners.

## Skills and knowledge

### The learner:

- Counts forwards and backwards in tens from any multiple of 10 between 0 and 100.
- Knows and reads number symbols from 1 to at least 100 and writes number names from 1 to at least 34.
- Orders, describes and compares whole numbers to at least 2-digit numbers.

Before learners practise counting in tens they must discover the patterns for how we group numbers in our counting system. Give them many varied opportunities to help them build understanding that there are big changes in the ways we read and write numbers beyond nine. The activities must help them to discover that, after nine, we begin to group in tens and in multiples of ten, and we place digits in different places to show their values. Once learners understand these placing and sequencing patterns, they can use them to extend their understanding of counting sequences to include all 2-digit numbers.

## Suggested activities

### 1. Developing ideas of grouping in tens

Introduce activities that help learners discover ways to organise and group objects for quick counting:

#### Finger and toe counting

Learners count the number of fingers on both their hands. Then ask questions like: "How many fingers do Mpho and Jane have altogether? ... Mpho, Jane and Fatima? ... How many fingers do 4 children have?", etc. Let learners, who need to do so, 'count all'. With more experience, through different activities, learners will naturally begin to use quicker counting strategies. Later, do similar work with numbers of toes. Encourage learners to imagine how many toes there will be each time. Where necessary, let them check by counting actual toes or drawings. Link this work to worksheets with body counting.



Learners	fingers	toes
1		
2		
3		
	50	
	70	
	90	

#### Threading strips

Give pairs of learners beads of two colours. They thread 9 beads of one colour onto a string and then thread one bead of the second colour onto the string. They continue with this pattern. Their strings must end with the 10<sup>th</sup> bead.

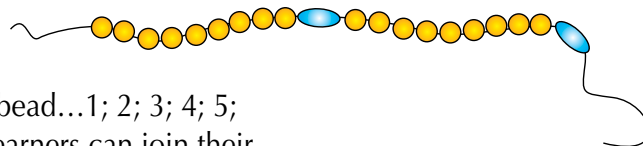
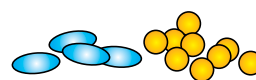

Learners count the beads out loud, emphasising the 10<sup>th</sup> bead...1; 2; 3; 4; 5; 6; 7; 8; 9; **10**; ...1; 2; 3; 4; 5; 6; 7; 8; 9; **10**; etc. Pairs of learners can join their strings and recount to find out how many they have altogether. Ask questions like: "How many groups of 10 beads have you got on your string? ... How many beads are there between each of your blue beads? ... If you string altogether 50 beads, how many groups of ten will you make?"

- Learners touch and count beads on an abacus or counting frame. Give instructions that encourage them to count in tens, e.g. "As quickly as you can, show me 20 beads.... 50 beads... 55 beads".
- If the money of your country is grouped in tens, as, for example South African 10 cent coins, let learners take handfuls of play coins and count up their total values in tens.

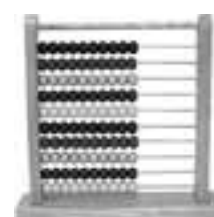

## Play, estimate and count

One learner puts out a handful of objects (e.g. beans, stones, counters) on the table. Each group member writes down his/her estimate of the number of objects. As quickly and accurately as possible, the group counts and checks the actual number of objects. The group winner is the learner who makes the closest estimate. Encourage groups to find ways to group their objects for quick, accurate counting and checking.

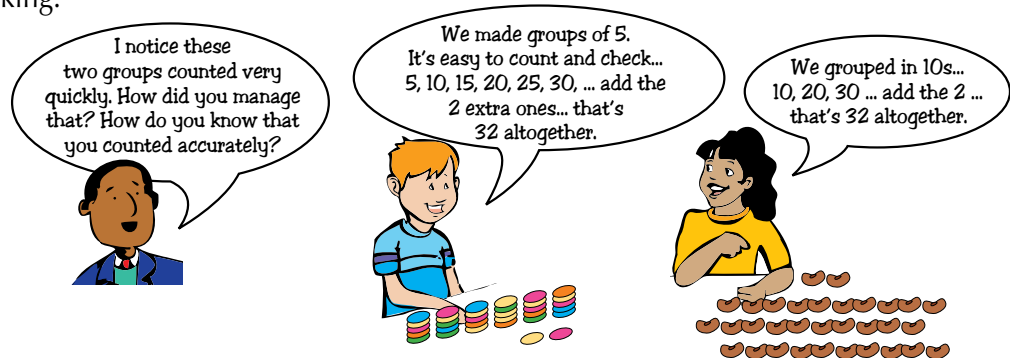

## Making bundles of ten

Let learners count out groups of ten matchsticks or tooth picks and bundle them together with elastic bands – they may need you to help them do this. Challenge them to use their bundles and their left over sticks to make up different numbers. Start with multiples of 10.

You can extend this activity to include 2-digit numbers that are not multiples of 10 (e.g. 16, 29, 34)

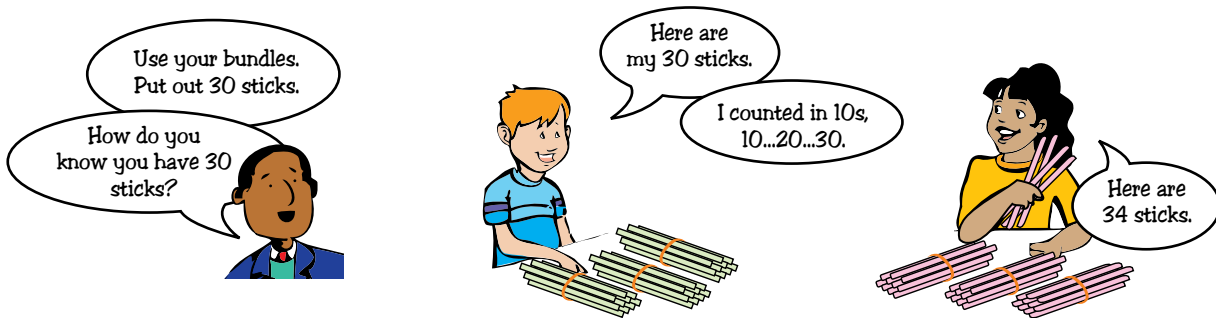

## 2. Counting in tens on number boards

### Counting in groups of 10

Let learners count backwards and forwards in tens. They place counters on the numbers and they say and explain the number patterns they see.

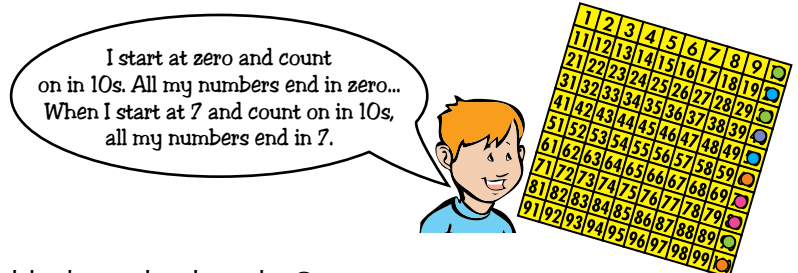

### Where's the number?

Learners practise counting on in 10s. Use blank number boards. One learner calls out a number between 10 and 40 (extend the range later). Group members find where the number goes on the board and explain their reasoning.

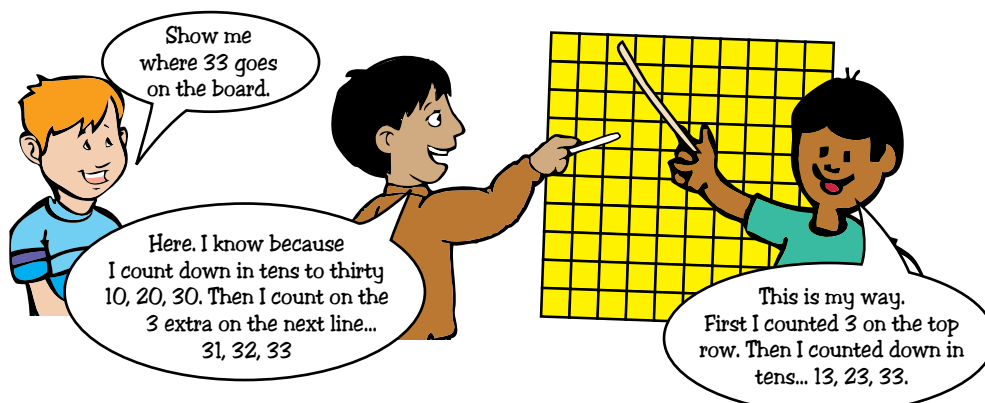

## Grade 1: Numbers, operations and relationships

### 3. Other concrete aids for grouping and counting in tens

Draw a grid like this on the chalkboard (add extra rows at the bottom). Let pairs of learners copy the grid. They take turns to write a 2-digit number of their choice in the first column and to put out either a tens card or a ones card in the middle column. Their partner must find the correct *Card I need* and place it in the last column. Learners check each other's solutions.

My Number	Card I have	Card I need
28	20	
34	4	

See Resources, p349.

#### Scatter boards

Draw, or let learners draw, a scatter board like this for each group of learners. Each learner takes 10 counters. They take turns to close their eyes and scatter their counters onto the board. They work out, and write down their scores. If a counter lands on a line, they use the tens value. In this example the score is 27. Group members can each add their scores from a series of throws and compare their results to find the overall winner.

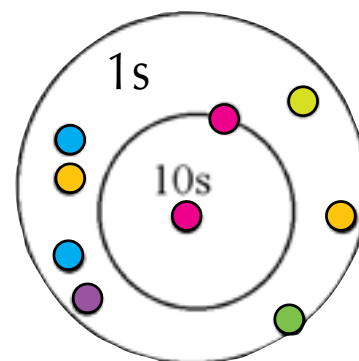

### 4. Written work with counting in tens

- Give learners pictures of different numbers of people. They count in 10s to find out how many fingers or toes the group has altogether. They find and write totals of fingers plus toes for their groups.
- Pose word problems that challenge learners to count in multiples, e.g. "There are 10 pencils in each box. How many pencils in 6 boxes? How many boxes must I buy so that I have enough pencils to give 35 children one pencil each?"
- Learners fill in missing tens on number boards or charts, number lines, pictures of a ruler or of a scale.
- Learners complete forward and backward number sequences in tens, starting from any number within the range that they are working, e.g. 10; 20; \_\_\_\_; 40; 50; \_\_\_\_; \_\_\_\_; \_\_\_\_; 90; \_\_\_\_

70; 60; 50; \_\_\_\_; \_\_\_\_; \_\_\_\_; \_\_\_\_; \_\_\_\_

Challenge learners who are ready to go ahead, to count forwards and backwards in tens starting from numbers that are not multiples of 10, e.g.: 4; 14; 24; 34; \_\_\_\_; \_\_\_\_; \_\_\_\_; 74; \_\_\_\_; \_\_\_\_

Later, once learners have learnt how to use the addition and subtraction symbols, you can extend the written sequences like this:

100  $\boxed{-10}$   $\rightarrow$  90  $\boxed{-10}$   $\rightarrow$  \_\_\_\_  $\boxed{-10}$   $\rightarrow$  \_\_\_\_

## Skills and knowledge

### The learner:

- Solves money problems involving totals and change in rands and cents.
- Uses the following techniques:
  - a) building up and breaking down numbers;
  - b) doubling and halving;
  - c) using concrete apparatus

In this document we use examples of South African money. Substitute examples of your own country's money as appropriate.

When we work with money, one coin can stand for more than one thing, e.g. a R5 coin stands for, or has the same value as, five separate one rands. Do not introduce learners to combined coins until they have established stable one-to-one correspondence for the numbers involved. Once learners have done so, money becomes a useful resource for developing and consolidating various concepts such as:

- the idea that one object can represent a number of objects;
- skip counting in various multiples;
- exchanging in different ways.

## Suggested activities

### 1. Becoming familiar with coins and notes and their values

Learners handle and compare different coins. Let them make pencil rubbings of the different coins and then compare, describe and discuss the similarities and differences between them. For example, let them:

- feel the edges of coins – explain how and why they differ (to help blind people);
- discuss the details of each coin – pictures on the back and front;
- compare the sizes of coins and arrange them in ascending and descending order according to their sizes;
- describe the symbols and numbers on the back and front of coins;
- make sure that learners understand that 5c is short for 5 cents, R10 is short for 10 rands etc.;
- compare and sort coins and arrange them in ascending and descending order according to their values;
- use 10c coins to count in tens;
- show learners examples of R10, R20, R50, R100 notes - let them compare them according to their values;
- let learners look for the watermarks on the notes - tell them why we use watermarks (to prevent forgeries);
- introduce, discuss and compare your play money - stress that this is 'pretend money' and that they cannot use it to buy anything.

### 2. Play bartering games

This helps learners to understand why people invented money. Explain that, before people invented money they traded or bartered goods. For example, if you had chickens and I had wheat we would make deals about how many chickens you should give me in exchange for a basketful of wheat. Later people started paying with goods that they saw as valuable such as shells, salt or pieces of metal.

- Learners find objects to trade at home or in the class, e.g. pencils, books,



## Grade 1: Numbers, operations and relationships

shoes, cases, sandwiches.

They negotiate trades in small groups.

- Discuss the advantages and the disadvantages of bartering, e.g. we can trade what we've got but it may be difficult to decide on what is a fair exchange. Point out that, in some situations, people still barter.
- When learners understand the idea of trading, you can discuss the advantages of using money (easier to carry around than chickens or wheat; we can have fixed prices so we don't have to make deals each time).

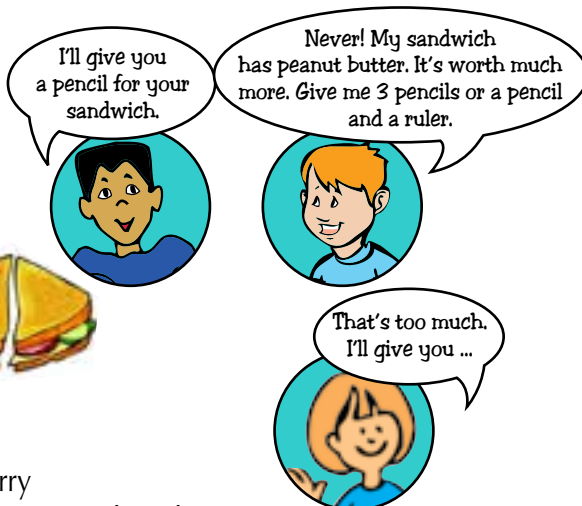

### 3. Exchanging games

Play exchanging games to become familiar with the values of different coins and notes.

- Start with notes, so that learners can find their values by exchanging for one rand coins. Give learners notes of different values. Learners must exchange them for the correct number of R1 coins. Let them draw and explain their exchanges.
- Later extend the game. Learners exchange their big notes for the correct number of R10 notes and then exchange combinations of notes (e.g. R20 + R50) in as many different ways as they can.
- Point out that in the 'old days' we had 1c coins and 2c coins. Let learners use counters to represent this 'old fashioned' money. Learners exchange 5c, 10c, 20c and 50c coins for the correct number of 'old fashioned' one cent coins. Let them draw and explain their exchanges. Later they can exchange rand coins for smaller value coins.
- Then let learners break coins or notes down into as many different combinations as they can. Start with small amounts and build up systematically (use counters).  
 $5c = 1c + 1c + 1c + 1c + 1c$ ;  $5c = 2c + 2c + 1c$   
 $R5 = R1 + R1 + R1 + R1 + R1$ ;  $R5 = R2 + R2 + R1$
- Learners also build up to different amounts, e.g. "Use R1 coins. Show me R15 ... Use 10c pieces. Show me 90c... Show me 100c... Show me R1".



### Banking games

Play banking games with play money. Let members of small groups take turns to be the 'banker'. The banker exchanges the money. Here are some examples of games:

- The banker gives each group member a different coin.  
For example, one group member gets a 20c coin, another gets a 50c coin and so on.
- Learners take turns to change their coins for the correct number of 5c coins at the bank. The rest of the group checks that each learner asks for the correct amount of money and that the banker counts out the correct amount of change each time.

## Grade 1: Numbers, operations and relationships

- Extend the game by letting the learners use bigger coins or by letting the banker give each learner more than one coin to exchange. Each learner tells the banker which coins he or she must give in exchange for their money. The rest of the group checks each exchange.
- Let learners find ways to record their exchanges and to explain their methods to each other.



### 4. Using money to count in tens

Use number spinners and play money.

Learners race to be the first one to get R2. They take turns to spin a spinner. The number that the spinner lands on tells the player how many ten cents the banker must give him or her. After each turn players add their money. As soon as they can exchange their money for a bigger coin they ask the banker to make the exchange.

See Resources,  
p356 - 357

To extend the game, learners race to larger amounts, e.g. R10.

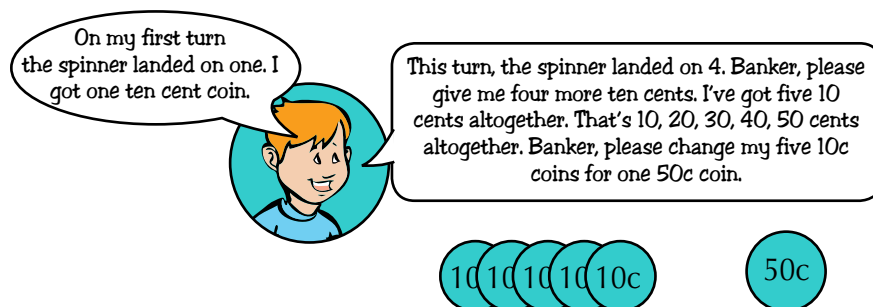
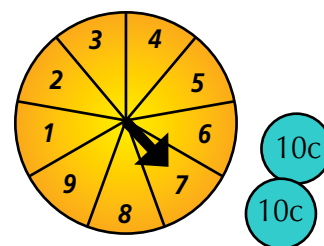

### 5. Word problems with money

Learners solve various kinds of word problems with money, e.g.

- Double or halve amounts of money, e.g. "Mpho has 50c. Tumi has double or half."
- Sharing/grouping, adding and subtracting, e.g. "You buy a sweet for 20c and a pencil for 50c. How much altogether?... Ma Kgaladi shares 90c equally between her children. Each child gets 30c. How many children does Ma Kgaladi have?"
- Breaking down or building up to find change, first in either rands or cents, e.g. "Mpho spends 70c. She gives the shopkeeper 80c. How much change does she get?" Later with change in rands and cents, e.g. "Mpho spends R1,50. She gives the shopkeeper R5. How much change does she get?"

Throughout, learners must explain and check their own and their peers' methods and solutions, using play money where necessary.

Work orally at first. Gradually show learners how to use the appropriate abbreviations to write amounts of money. As learners want to write amounts that combine rands and cents, make sure that they understand how we use the comma to separate rands from cents.

## Skills and knowledge

### The learner:

- Solves and explains solutions to practical problems that involve equal sharing and grouping with whole numbers to at least 34 and with solutions that include remainders.
- Uses the following techniques:
  - a) building up and breaking down numbers;
  - b) doubling and halving;
  - c) using concrete apparatus;
  - d) number lines.
- Explains own solutions to problems.
- Checks the solutions given to problems by peers.

## Suggested activities

Start by exposing learners to practical sharing situations that arise in various contexts in their lives, e.g. food, books, pencils, money, non-standard mass, length and capacity. Through the year, let learners work with increasingly large numbers up to at least 34. In different contexts, introduce both equal sharing and equal grouping problems.

### Examples:

Equal Sharing Problems	Equal Grouping Problems
1) We share 12 flowers equally among 4 children. How many flowers does each child get?	1) We share 12 flowers equally between some children. How many children can each get 4 flowers?
2) Mother shares R4 between 2 children. How much does each child get?	2) Ma Nkosi shares R4 between all her children. Each child gets R2. How many children does Ma Nkosi have?
3) Four children share 5 oranges equally. How many oranges can each child get?	3) 16 children go to the zoo. Four children at a time may go in to look at the polar bears. How many groups of four will the Zoo Keeper have to take through?

Give learners the time and the freedom to investigate and discuss these situations. Challenge them to think of their own ways to share or group the various items and to explain what they do and what they find out. Encourage learners to say what they think the result of the problem will be (estimate) before they start working – this will encourage them to begin to think more abstractly by imagining the problem situations. Learners can then find different practical ways to check their own and their peers' ideas.

At first learners may need to work concretely to manipulate the actual objects described in the problem. As they gain confidence and experience, they will want to find 'shortcuts' by representing and recording their methods and solutions in ways that they understand. For example, they may find it helpful to represent non-available objects with their fingers or with counters or to record their ideas in rough drawings.



## Grade 1: Numbers, operations and relationships

Many learners find drawings easier than counters. Depending on their prior experiences and the different ways that they think and learn, different learners will use different techniques to solve and record their ideas. Below are examples of how different learners may respond to this grouping problem:

“Mrs Mafone has 14 buttons to sew onto all the jerseys she knits. She sews 5 buttons on each jersey. For how many jerseys does she have enough buttons?”

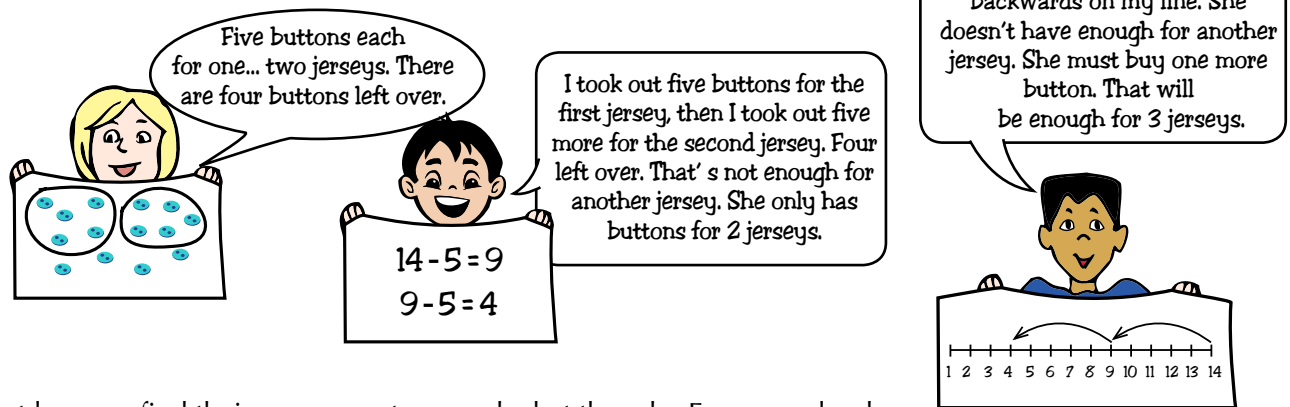

Let learners find their own ways to record what they do. For example, do not suggest that learners who are able to imagine and represent amounts correctly with number symbols, go back to using dots or other concrete representations (but allow them to do so if they feel the need). Also do not force learners to adopt somebody else's method because it seems quicker or easier. With continued exposure, practice, growing understanding and confidence, learners will naturally try to find or adopt quicker methods that they understand to illustrate their thinking. After learners have tried to find their own methods, the educator can choose to demonstrate alternative methods and provide opportunities for learners to use them.

Notice how the learners in the example find practical ways to deal with remainders and to use their own informal language to explain these ideas. It is not necessary to introduce the terms, 'remaining' and 'remainder' until learners have had sufficient opportunities to develop their own practical understanding of these concepts.

## Skills and knowledge

### The learner:

- Can perform calculations, using appropriate symbols, to solve problems involving:
  - a) addition and subtraction with whole numbers and solutions up to at least 34;
  - b) repeated addition with whole numbers and with solutions up to at least 34;
  - c) estimation
- Uses the following techniques:
  - a) building up and breaking down numbers;
  - b) doubling and halving;
  - c) using concrete apparatus;
  - d) number lines.
- Explains own solutions to problems.
- Checks the solutions given to problems by peers.

## Suggested activities

As with sharing and grouping, help learners to develop addition and subtraction skills by presenting them with a wide variety of relevant practical problems that relate to their lives.

### Practical problem solving

As addition and subtraction are reversible operations, it is not necessary to teach them separately. You will find that, if you start by introducing challenging problems, different learners may use different operations, in different ways, to solve the same problem. They may solve what you think of as an 'addition problem' by subtracting or a 'multiplying problem' by repeated addition. They will also use different techniques and skills. In this way learners learn to fall back on their own resources to discover and use number facts.

### Finding the right problems

The level of the problems should neither bore nor intimidate learners. If learners constantly meet problems that are too easy for them, or problems that always look the same, they will not be challenged to build new knowledge and skills. If the problems are too difficult they will convince learners that they cannot do maths! Provide problems that cater for the different needs and levels of all the learners in your class. One way to do this is to build up sets of simple work cards that challenge at different levels.

There are a number of ways to adjust problems to challenge learners appropriately:

- Use different contexts to adapt the problems to your learners' interests, and home and school environments. This helps them discover how to use and extend their number knowledge and the techniques they already know in different situations.
- Increase or decrease the size of the numbers to match different learners' number knowledge.
- Use different problem types. There are four main problem types for adding and subtracting: change problems, comparing problems, equalising problems and combining problems (see the table on page 40 for examples of each kind of problem).

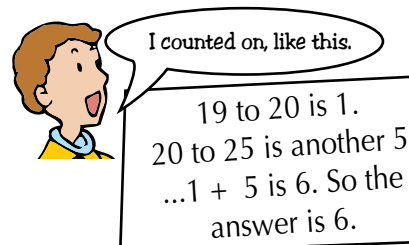
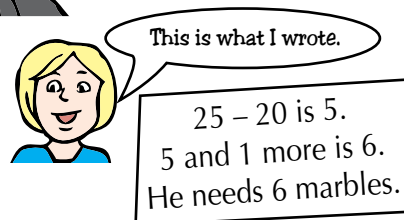
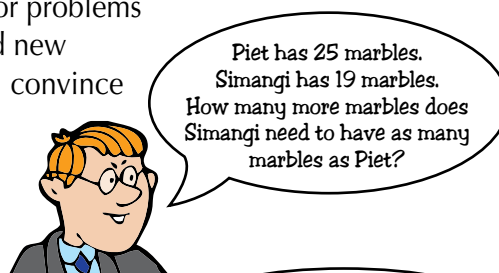

## Grade 1: Numbers, operations and relationships

- Change the position of the 'unknown' (the part of the problem that your learners must find out). There are three ways to change the position of the unknown in most problem types:

**Start unknown** - The unknown is at the start of the problem:

For example: "Mpho has some biscuits. Sam gives him 4 more biscuits. Now Mpho has 12 biscuits. How many biscuits did Mpho start with?"

In formal maths, we represent this type of problem like this:

$$\square - 4 = 12$$

Do not introduce such abstract equations at the beginning. Learners will gradually learn to read and write these mathematical formats as you help them to extend their own early, informal ways to read and write maths.

**Change unknown** – The unknown is in the middle of the problem:

For example: "Jan had 8 marbles. He loses some to Popo. He has only 1 marble left. How many marbles did Jan lose to Popo?"

$$8 - \square = 1$$

**Result unknown** - The unknown is at the end of the problem:

For example: "To get to school, Lesego walks 2 km to the bus stop and travels 5 km on the bus. How far is Lesego's school from his house?"

$$2 + 5 = \square$$

- Present word problems that encourage learners to use, extend and practise their number techniques and skills:

### Building up and breaking down numbers

For example: "You have R12. Find as many different ways as you can to share the R12 between two people". R1 for one person and the other R11 for the other; R2 plus R10, etc.

### Doubling and halving

For example, "David starts with R24. Everyday he spends half the money in his pocket. After how many days will he have only R3 left?"...

"Susan makes one sandwich on Monday. On each day of the week she makes twice as many sandwiches as the day before. How many sandwiches will she make on Saturday?"

### Number tracks and number lines

As learners build understanding of how to use number tracks and number lines, they may choose to use these as aids to solve and record their solution methods. For example, a learner may work out Lesego's distance problem (above), like this:

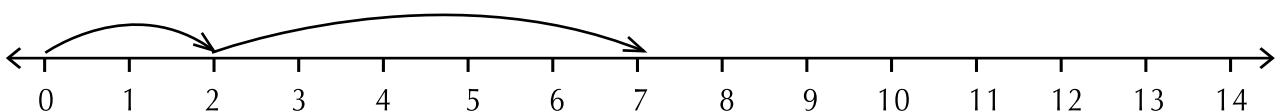

## Grade 1: Numbers, operations and relationships

### Repeated addition

Help learners to use and extend their skills for counting in multiples by posing problems that encourage them to do repeated adding.

For example, "There are 10 children in the room. How many eyes altogether? ... How many ears? How many fingers/toes?" or,

"Rashaka plants trees in rows. He plants 6 trees in each row. He plants 4 rows.

How many trees does he plant altogether?" ( $6 + 6 + 6 + 6 = \square$ ) or,

Rashaka has 24 plants. He plants them in rows of 6. How many rows must he plant?"

### Estimation

Encourage learners to estimate the result of the problems before they start calculating – this will encourage them to begin to think more abstractly by imagining the problem situations and their outcomes.

#### Examples of main problem types for addition and subtraction

##### Change problems

##### Start unknown

$$\square + 4 = 12$$

1) Mpho has some biscuits. Sam gives him 4 more. Now Mpho has 12 biscuits altogether. How many biscuits did Mpho start with?

$$\square - 10 = 2$$

2) Mpho's mother gives him pocket money. Mpho spends R10. He has R2 left. How much pocket money did Mpho get?

##### Change unknown

$$8 + \square = 22$$

1) Jan has 8 marbles. He buys some more marbles. Now Jan has 22 marbles. How many marbles did he buy?

$$8 - \square = 1$$

2) Jan has 8 marbles. He loses some to Popo. He has only 1 marble left. How many marbles did he lose to Popo?

##### Result unknown

$$2 + 5 = \square$$

1) To get to school, Lesego walks 2 km to the bus stop and travels 5 km on the bus. How far is Lesego's school from his house?

$$18 - 5 = \square$$

2) Lesego had 18 apples. He gives 5 apples to Katlego. How many apples does he have left?

## Grade 1: Numbers, operations and relationships

Comparing problems	
<p><b>Start unknown</b></p> <p><math>\square = 9 + 5</math></p> <p><math>\square = 9 - 5</math></p>	<p>1) Mary has some T-shirts. She has 5 more T-shirts than Ben. Ben has 9 T-shirts. How many T-shirts does Mary have?</p> <p>2) Mary has some T-shirts. She has 5 less T-shirts than Ben. Ben has 9 T-shirts. How many T-shirts does Mary have?</p>
<p><b>Change unknown</b></p> <p><math>12 - \square = 7</math></p> <p><math>7 + \square = 12</math></p>	<p>1) Jan has 7 sweets. Dan has 12 sweets. How many more sweets does Dan have than Jan?</p> <p>2) Jan has 7 sweets. Dan has 12 sweets. How many fewer sweets does Dan have than Jan?</p>
<p><b>Result unknown</b></p> <p><math>7 - 4 = \square</math></p> <p><math>7 + 4 = \square</math></p>	<p>1) Jan has 7 sweets. He has 4 more sweets than Dan. How many sweets does Dan have?</p> <p>2) Jan has 7 sweets. He has 4 fewer sweets than Dan. How many sweets does Dan have?</p>
Equalising problems	
<p><b>Start unknown</b></p> <p><math>\square = 33 - 10</math></p> <p><math>\square = 13 + 10</math></p>	<p>1) Sue and Simangi have a hopping competition. Sue wins by 10 hops. She hops 33 times. How many times did Simangi hop?</p> <p>2) Sue and Simangi have a hopping competition. Sue loses by 10 hops. She hops 13 times. How many times did Simangi hop?</p>
<p><b>Change unknown</b></p> <p><math>11 + \square = 17</math></p> <p><math>16 + \square = 19</math></p>	<p>1) Sue hops 17 times. Simangi hops 11 times. How many more times must Simangi hop to catch up to Sue?</p> <p>2) Sam hops 16 times. Sue hops 19 times. Who makes less hops? How many less?</p>
<p><b>Result unknown</b></p> <p><math>29 - 3 = \square</math></p> <p><math>29 - 3 = \square</math></p>	<p>1) Simangi hops 29 times. Sue must make 3 more hops to catch up to Simangi. How many hops does Sue make?</p> <p>2) Simangi hops 29 times. Sue makes 3 less hops than Simangi. How many hops does Sue make?</p>
Combining problems	
<p><b>Start unknown</b></p> <p><math>\square = 15 + 15</math></p>	<p>Ranjit has some sweets. 15 of his sweets are toffees. 15 of his sweets are jelly babies. How many sweets does he have?</p>
<p><b>Change unknown</b></p> <p><math>13 = \square + 2</math></p>	<p>Ranjit has 13 sweets. Some of his sweets are jelly babies. Two of his sweets are toffees. How many of his sweets are jelly babies?</p>
<p><b>Result unknown</b></p> <p><math>13 - 2 = \square</math></p>	<p>Ranjit has 13 sweets. Two of his sweets are toffees. The rest of his sweets are jelly babies. How many of his sweets are jelly babies?</p>

## Grade 1: Numbers, operations and relationships

### Reasoning, discussing and checking

Give learners the time and the freedom to work in pairs or in small groups to investigate and discuss these situations.

Challenge them to think of their own ways to solve problems, using their available number knowledge and skills, e.g. counting in different ways, place value, exchanging money and techniques (building up and breaking down numbers, doubling and halving, concrete apparatus, number lines). If you expect learners to use symbols and formal calculating methods from the beginning you will confuse and de-motivate them.

To expose your learners to different ideas about how to solve problems, let them take turns to use their own informal language to share and explain what they do and what they find out. Remember that, for most of us, home language is our most powerful learning and thinking language.

Encourage learners to listen carefully to each other's explanations and to find different practical ways to check their own and their peers' ideas and calculation methods. Where necessary, ask guiding questions to help them clarify and extend their ideas.

At first learners may need to work concretely to manipulate the actual objects described in the problem. As they gain confidence and experience, they will want to find 'shortcuts' to represent and record their methods and solutions in ways that they understand. For example, they may find it helpful to represent non-available objects with their fingers or with counters or to record their ideas in rough drawings. Many learners find drawings easier than counters.

As you observe, assess how different learners are thinking and what support they need. Also judge when learners are ready to refine and move from their early informal solution and recording methods to more compact and formal methods.

As you see that various learners understand and are confident with the new maths ideas, gradually introduce appropriate maths terms and symbols that will help them use shorter ways to represent their ideas and knowledge.

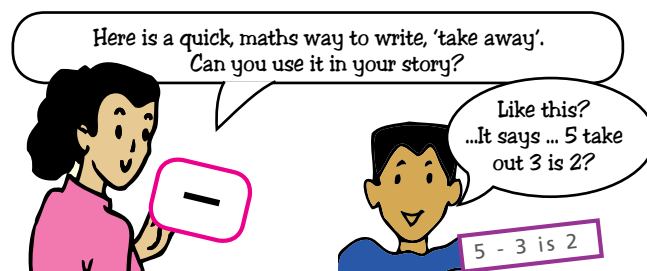

## Grade 1: Numbers, operations and relationships

Also gradually introduce learners to other mathematical formats that will help them to organise their ideas systematically.

For example, for the problem, "You have R7. Find as many different ways to share the R7 between two people", you can model how they can organise their findings in a spider diagram:

e.g. I can break 7 up in all these ways:

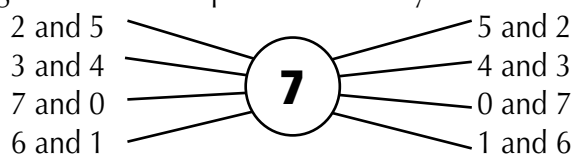

Here are some other interesting formats you can introduce to help learners represent their doubling and halving methods and to help them practise these techniques alongside the work you do with problem solving.

### Table format

Double	
13	26
16	32
14	28

Half	
26	13
13	6½
24	12

### Pyramid format

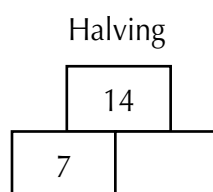
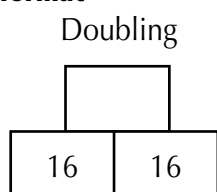

### Spider web format

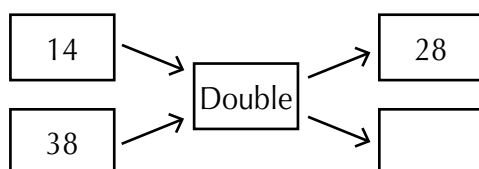

### Remember:

Never force learners to adopt somebody else's method because it seems quicker or easier. With continued exposure, practice and growing understanding and confidence, learners will naturally try to find or adopt quicker methods to illustrate their thinking.

## Skills and knowledge

### The learner:

- Performs mental calculations involving addition and subtraction for numbers to at least 10;
- Uses the following techniques:
  - a) building up and breaking down numbers;
  - b) doubling and halving;
- Explains own solutions to problems.
- Checks the solutions given to problems by peers.

## Suggested activities

### 1. Developing mental tasks

As learners build maths knowledge they will gradually become more and more able to work mentally. To support this growth you should, on a daily basis (for about 10 to 15 minutes), present learners with different kinds of mental tasks that:

- Interest, motivate and challenge them to think and to find their own ways to calculate mentally;
- Help them to use what they know to see patterns, derive new facts and ideas and to use and practise their knowledge to solve problems;
- Link their mental activity to the maths concepts and contexts they have been developing, e.g. money, time, informal measurement, equal sharing and grouping, adding and subtracting.

You can then link this number knowledge to different kinds of related word problems:

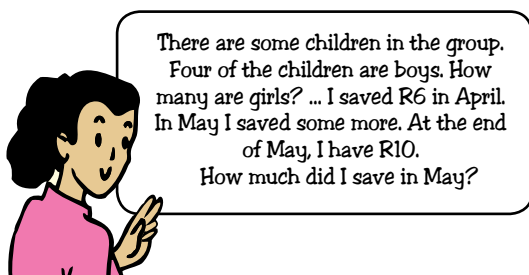

You can also use these sessions to challenge learners to work mentally with aspects of a variety of mathematical ideas. For example, if you are working with shapes, your mental activity might encourage learners to visualise and name them.

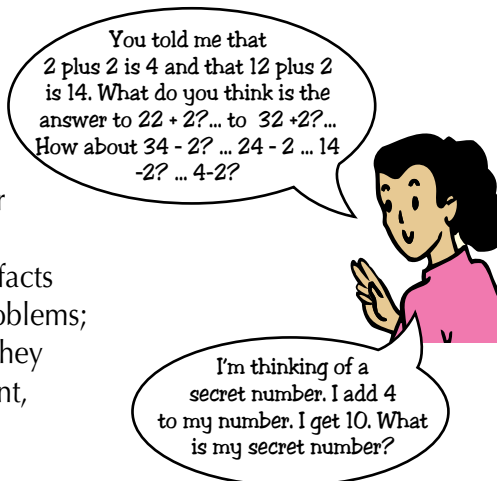
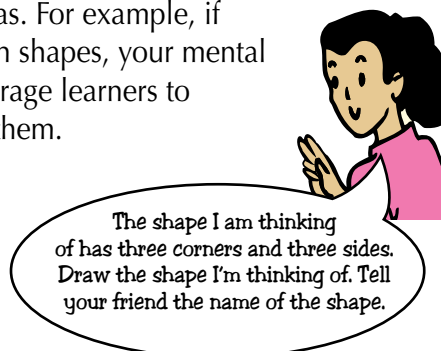

### 2. Organising your mental maths sessions

Mental sessions should be thinking sessions rather than rote memory or speed sessions that only require learners to give accurate answers as quickly as possible. Ensure that everybody in the class becomes involved - not only those learners with quick recall who may distract everybody else by waving their hands, clicking their fingers and/or shouting to get your attention.

Through your actions, show that you respect all learners, and aim to build their confidence and ability. For example:

- Provide thinking time during which everybody must think or work quietly;
- Set rules like; "Nobody should put their hand up before I give you the signal" or "If you know the answers, you can raise your thumb quietly to show me you have the answer!"
- Call for answers and explanations from anyone –not only those who raise their hands;



## Grade 1: Numbers, operations and relationships

- Let learners discuss and share their different thinking methods with the whole class;
- Show that you accept different ways of thinking – as long as they make sense;
- As learners develop ways to calculate and solve problems, encourage them to speed up their responses.

You can start by working with the whole class. At first learners will find it easier to understand and respond to questions if they see, as well as hear, them. So if learners struggle with oral presentations, show the questions on flash cards or write them on the chalkboard. Let learners write their answers on a slate or on rough paper and then share their solutions and their methods. Start with what learners need and build up slowly to the more difficult oral work – although you may have to go back to visual presentations when you start on new work.

Once learners can read fairly fluently, present a series of linked questions in written form, e.g. on work cards. Learners can then work independently or in small groups to write the answers.

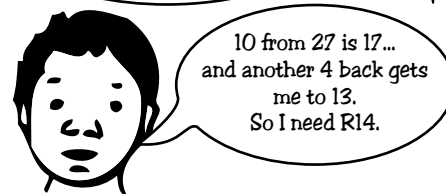
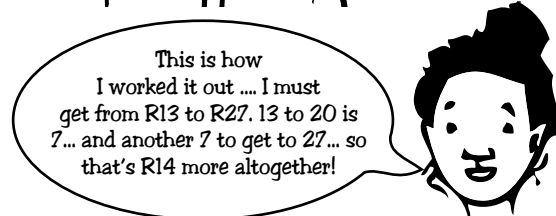
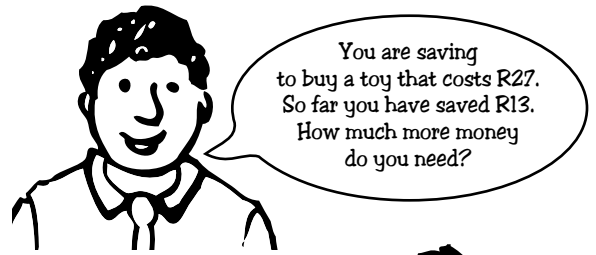

## Grade 1: Numbers, operations and relationships

### Vocabulary

If you do not teach in English, use equivalents in your language of instruction.

#### Grade 1:

- number names (one, two, etc.)
- ordinal number names (first, second, third, etc.)
- more, less, fewer, as much as, a little, a lot
- same, different
- equal, about, nearly, none
- total, altogether, count
- cents, rands, exchange
- pieces, parts, share, group, share equally, share between, among
- equal shares (or parts)
- break up
- estimate
- put together, add, build up, break down, take away, subtract, (minus)
- double, halve
- number names up to 100
- count in tens

#### Grade 2 – add the following to the Grade 1 vocabulary:

- fives, twos, odd numbers, even numbers
- fraction names e.g. half, halves, quarter(s), fourths, thirds, fifths, sixths, one and a half, two and a quarter
- wholes, parts, pieces, left over, remains, remainder
- twice, three times (etc), multiply by

#### Grade 3 – add the following to the Grade 1 and 2 vocabulary:

- number names up to one thousand
- tens, units, ones
- twenties, twenty-fives, fifties, hundreds

### Resources

- objects in learners' environment, different counters (e.g. bottle tops, beans, used matchsticks, plastic shapes, pencils, washing pegs, buttons, unifix blocks, leaves, sticks, stones)
- body parts (eyes, ears, limbs, fingers)
- number tracks and number lines
- number charts or boards, number cards (spray/flash cards)
- sandpaper numbers
- play money
- worksheets
- calendars
- number spinners



# Grade 1: Patterns, functions and algebra

The learner will be able to recognise, describe and represent patterns and relationships as well as to solve problems using algebraic language and skills.

## Skills and knowledge

### The learner:

- Copies and extends simple patterns using physical objects and drawings (e.g. using colours and shapes).
- Creates own patterns.
- Describes observed patterns.
- Identifies, describes and copies geometric patterns in natural and cultural artefacts of different cultures and times.

The vocabulary that learners need to understand and use for these skills is listed at the end of the suggested activities. You will find it helpful to make flash cards with key vocabulary words to support the teaching and learning process. A list of the resources you will need for the activities is also provided. (See [Resources](#))

## Suggested activities

### Early experiences of patterns

Young children come across patterns, in many different situations as they venture out into the world. They find their own ways to describe them.

They may draw them in the sand or paint pictures of them.

Pattern experiences help young children to make meaning and bring order to their world. As educators, our task is to extend the innate curiosity for patterns that our learners have and develop their ability to copy, extend, describe, generalise and create repeating or growing patterns of their own.

We can help them to:

- see the relationships between the elements of a pattern;
- spot what's the same and what's different;
- see how patterns repeat, change or grow in different ways.

Through these experiences learners also develop the language they need to communicate, share and build on their experiences.

Here are more simple patterns that children may experience in the world around them:

### Cyclical patterns

Natural cycles happen all around us, e.g. moon and sun, day and night, growing older.



The big frogs lay eggs, then baby tadpoles come. They grow into big tadpoles. Then they become baby frogs, then big frogs, that lay more eggs, and it starts all over again.

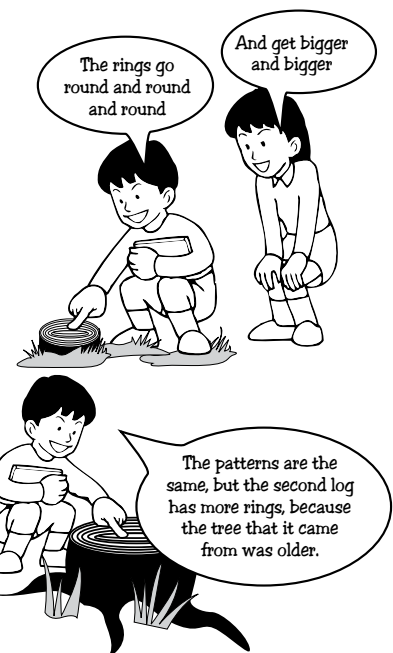

**Number patterns**

10 20 30 40 50 60 70 80 90



In this pattern, the last digit stays the same but the first one gets bigger by one each time.

**Shape and number patterns**



This block pattern is neat! The number of shaded blocks doubles each time!

	1								
		2							
				4					
								8	

**Preparing the classroom**

**Pattern posters**

Make two posters, one with pictures or drawings that show man-made patterns (including cultural patterns), and the other with examples of natural patterns.

Here are some examples you could include:

**Natural patterns**

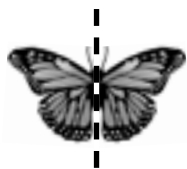

The symmetrical pattern of a butterfly's wings.

Animal footprints in the sand.

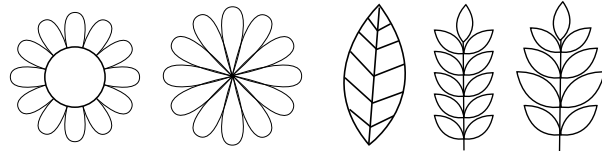
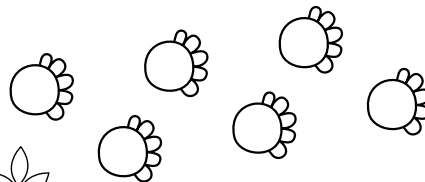

Patterns in flower formations.

Repeating cyclical patterns like growth cycles

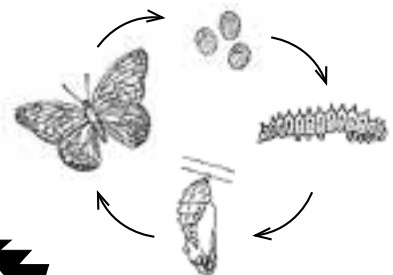

**Made patterns**

Designs on African artefacts.

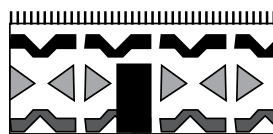

Patterns found in different cloth designs.



# Grade 1: Patterns, functions and algebra

## Patterns in the classroom

- Talk about the different patterns together. For example, ask learners to find examples of patterns around the classroom. The pattern formed by the small window panes making up the window, the roof trusses, floor tiles or a carpet.
- Explore patterns like the wheels on bicycles, tricycles or cars; the number of corners on a square or triangle; the number of points on different-shaped stars.
- Encourage learners to think about and explain what 'makes a pattern'. They should understand that unlike a random arrangement, the elements of a pattern are repeated. In some cases, like in this design for a mat, the pattern is repeated and it also 'grows'.

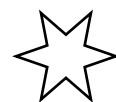
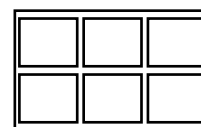
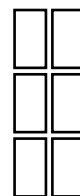

5 points 6 points

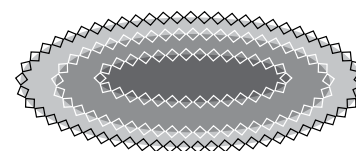

This pattern, where the number of squares increases by one each time, is also a growing pattern.

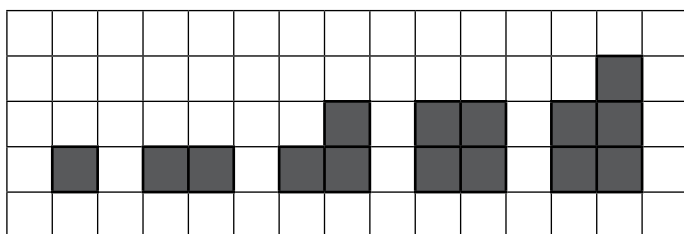

## Out and about

- Take learners on a walk around the school grounds to look for different kinds of patterns, both in the natural and in the built environment. As you move from one spot to another, give different learners the chance to describe and compare the different patterns they see.
- In a follow-up Art lesson, ask the learners to draw the patterns they have seen on the walk, using crayons, kokis or paints. Finger paints work well for this.



## Patterns and rhythm

- Begin a rhythmic pattern by clapping and stamping your feet and then ask learners to join in:

*Clap, clap, stamp, clap, clap, stamp ... Or*

*Stamp, stamp, clap, clap, clap, stamp, stamp, clap, clap, clap ...*

Give learners chances to make up their own clapping and stamping patterns that the rest of the group must then follow.

- Play a scale up and down on a piano, recorder or harmonica. Ask learners to sing along with you and to try and 'feel' the pattern in the melody as they do.
- Play a piece of music or sing a song that your learners know well. Have them clap or stamp out the beat as they do so. Choose another piece with a slower or faster beat. Ask them to talk about the differences between the two beats.

## Shape patterns

When we introduce young learners to a variety of **shape patterns** we can help them find out about the geometric properties of different shapes. We can also help them start to reason about patterns.

### Linking rhythmic patterns to shape patterns

- Show learners how to represent their clapping and stamping patterns using different shapes or colours.

For example, they can show the pattern: *Clap, clap, stamp, clap, clap, stamp*, like this:

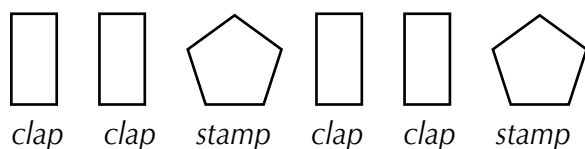

or *stamp, stamp, clap, clap, clap* like this:

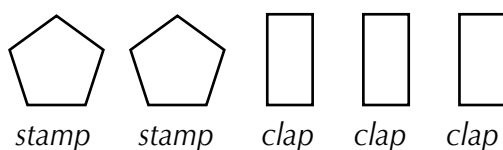

- Begin a new clapping pattern. For example: *Clap, clap, stamp, stamp*. Using coloured shapes or blocks, learners must build a matching pattern. They can then take turns in their groups to make up their own clapping patterns and ask the other members of their group to copy their pattern using coloured shapes or blocks.

## Dot patterns

Begin a pattern like this on the board:

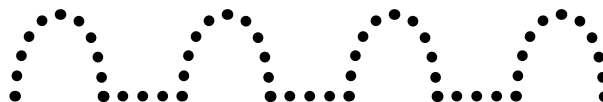

Ask the learners to say how it should continue.

Ask them to describe the pattern in their own way. For example:

*curve line curve line curve line curve line ...*

*bend, straight, bend, straight, bend, straight, bend, straight, ...*

*tunnel, path, tunnel, path, tunnel, path, tunnel, path ...*

*skip, step, skip, step, skip, step.*

Adapted from Marilyn Burns,  
*About Teaching Mathematics*, A Maths  
solutions Publication.

## Hand writing patterns

Copying and extending patterns help learners to develop their writing and co-ordination skills.



## Grade 1: Patterns, functions and algebra

### Repeating bead patterns

In this sequence of activities, learners copy, make, discuss and compare repeating patterns that they make with beads and threading laces, or similar materials they can thread. They can use clay, coloured pieces of macaroni, different kinds of seeds, etc to make the beads. Give each group of learners a collection of these materials to work with, either alone or in pairs.

- Make up your own example of a threaded pattern that has a repeating design for learners to first look at, discuss and then copy.
- Ask them to explain how the pattern 'works', what elements it is made from and how these elements repeat.
- Encourage them to use words like: *starts again, over and over, one more time* and so on.
- If you have used beads with identifiable shapes, see if they can name the shapes as well.
- Let learners then make up their own repeating patterns with their materials.
- Make time for them to discuss, share and compare their examples.

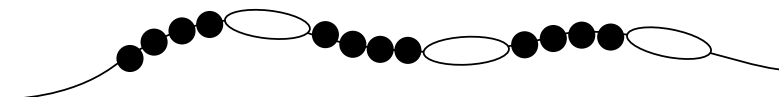
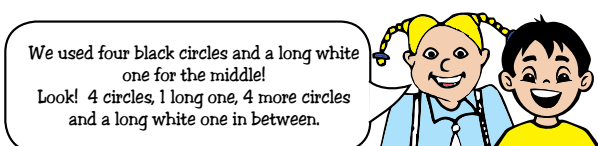
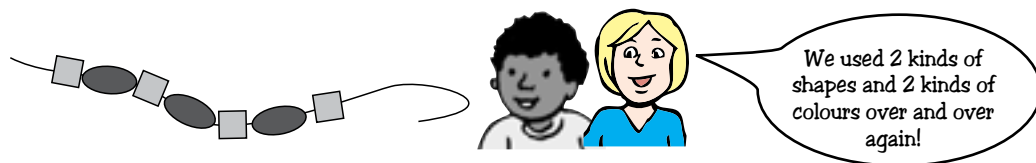
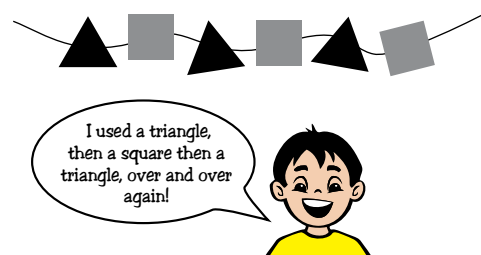

- They can then count how many of each kind of bead there are, and how many beads there are altogether.
- **Group challenge**  
Ask learners in each group to work together to use as many of the beads on the table as they can to make the 'longest' possible repeating pattern. It should repeat at least three times. The challenge will be for them to first sort the different beads and then work out how to make a pattern that uses as many different kinds of beads in one sequence as possible. They can then repeat the pattern a few times.

### Repeating shape patterns

- Give out paper or plastic shapes.  
Learners can work in pairs or in small groups to make repeating patterns. Start off by drawing a shape/colour pattern on the board for them to copy, using their materials.

For example:

They then repeat this sequence three or four times.



## Grade 1: Patterns, functions and algebra

- Next draw more shapes to extend your pattern and have them do the same to theirs.



Then learners repeat the sequence.



- Use the opportunity to talk about the different shape names as well as the position of the shapes, using language like *first*, *second*, *last*, *next*, *the one before* and *the one after*.

### Representing the same pattern in different ways

To extend their understanding of repeating patterns, help learners to identify different ways of representing the same pattern, as we suggested in the example for rhythmic clapping:

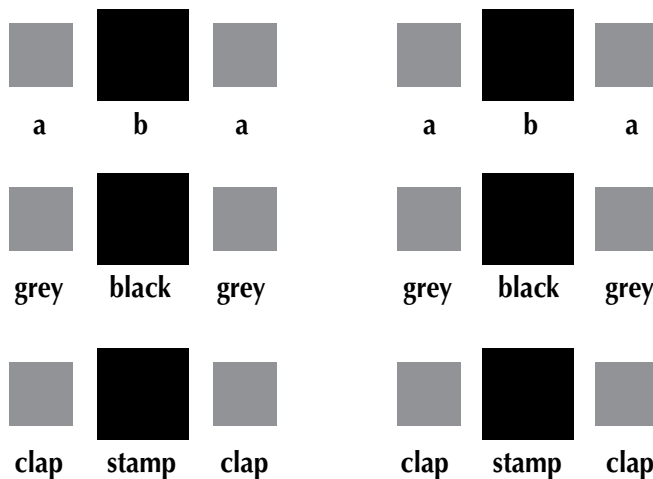

Talk about how the representations are both the same and different. This will help them to generalise the relationship between the elements in the pattern and their position in the pattern.

### Drawing patterns

Learners can use crayons or paints to make their own patterns. They can make printing patterns with potato cuts using stencil cut-outs.

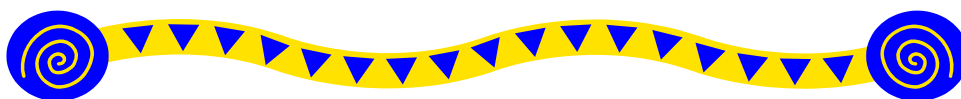

### Repeating border patterns

Learners can draw their own repeating patterns to create a design or a border for a page. They can also complete a pattern that you start for them:

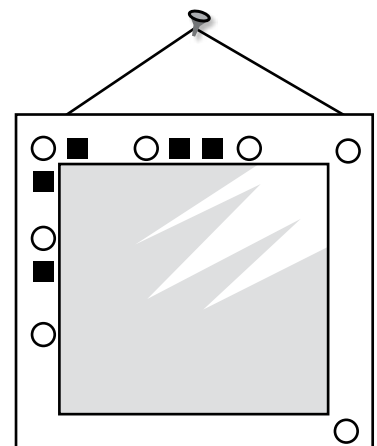
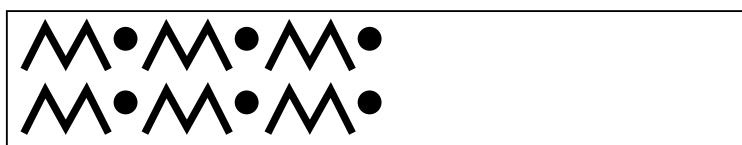
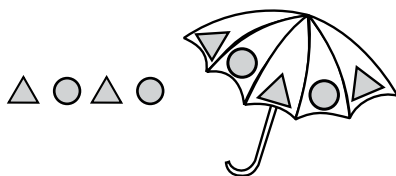

# Grade 1: Patterns, functions and algebra

## Growing patterns

Growing patterns differ from repeating patterns in that there is a change (an increase or decrease) in the number of elements. These activities also help learners to understand how patterns help them to make predictions. As they describe the patterns and justify their predictions, they will also develop the vocabulary to describe location and relative positions of the elements of the patterns.

### Birds on a wire

Prepare a worksheet with pictures of birds sitting on a wire, or similar images.

- In the first example, increase the number of birds by one each time.



Ask learners questions:

“How many birds on the first wire, the second wire, the third wire?”

“Predict how many birds there will be on the fourth or fifth wire.”

- Next begin the pattern with 2 birds on the first wire and increase the number of birds by 2 each time.



Ask questions:

“How many birds on the first wire, the second wire, the third wire?”

“Predict how many birds will be on the fourth or fifth wire in the pattern.”

- Next prepare drawings where the numbers of birds decrease in number each time. For example:  
Begin with 5 and decrease by 1 each time;  
Begin with 10 and decrease by 1 each time;  
Begin with 16 or 20 and decrease by 2 each time.

### Growing squares

- Show learners the following pattern where each part of the pattern is numbered according to its position in the sequence.

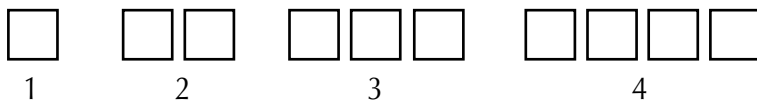

Position 1

As in the case of the bird pattern, the number of shapes and their position in the sequence is the same. There is 1 square in position 1; 2 in position 2; 3 in position 3 and 4 in position 4.

- Next give them examples where the position in the pattern is different from the number of elements in each group. Help learners to see and explain that, in this example, the number of squares is one more than the position number.

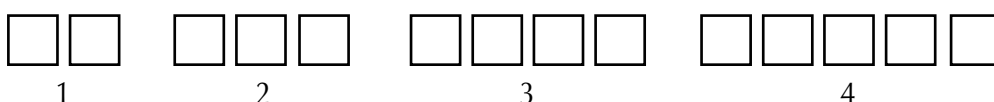

- Ask learners questions that help them to generalise the rule for the pattern like:  
“So if have 7 squares in the pattern, what will its position number be?”  
“How many squares will be in position number 10?”

### Making growing patterns

- Let learners build up shape patterns according to your instructions. Present some patterns where the position corresponds with the number of elements, and other patterns where the position number is one more or one less than the number of elements. For example:  
“Start a pattern using 3 triangles . Then increase the number of triangles by one each time”.

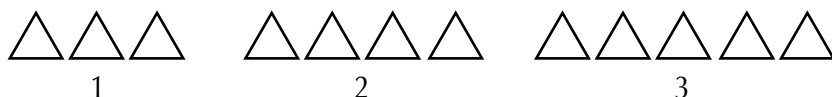

- Ask learners to use own shapes to make up their own patterns. They must extend their patterns and write the position number under each group. Then ask them questions like:  
“Without drawing the triangles, can you say how many triangles you need for position 10?”  
“If I have 15 triangles in the pattern, what position number can I make?”

## Skills and knowledge

The learner:

- Copies and extends simple patterns using physical objects and drawings (e.g. using colours and shapes).
- Copies and extends simple number sequences to at least 100.
- Creates own patterns.
- Describes observed patterns.

## Suggested activities

### Introducing number patterns

Over thousands of years, people from different parts of the world contributed ideas that influence the way we write numbers today. To help young learners understand our number system, they need to learn both the order of numbers (ordinality), and their value (cardinality). The way we sequence numbers, how we group them in tens and in multiples of tens, can best be understood by looking for ‘patterns’ in the structure of our number system.

All number pattern work from Grade 1 onwards integrates with sequencing, counting, grouping and calculating. It is important to remember that , even if we do not do formal place value work in Grade 1, once learners work with numbers beyond 10, they are already encountering place value relationships and patterns.

Chanting numbers by rote helps learners’ memorisation skills, but it is not enough on its own. By being trained to observe and use patterns, learners will be able to sequence, write, read and say the numbers with greater meaning. During the early stages learners need concrete aids such as counters, number dot cards, number cards, number boards and grid paper to help them develop their patterning skills.

## Grade 1: Patterns, functions and algebra

While Grade 1 learners do not calculate with numbers beyond 34, they are expected to know, read and write number symbols from 1 to 100. This does not just mean knowing the order, and how to say or write the numbers from memory, but also understanding the values of the numbers, what patterns or 'groups' they belong to, and how to compare them.

So, for example, when counting in 10s or writing the pattern for 10s, learners must also understand that each number is 10 more than the number before it.

10 20 30 40 50 ...

Even when children are learning to count, read and write numbers beyond 10, they can use patterning to help them remember the numbers in the sequence from 0 – 40.

Bella is trying to write the numbers from 0 – 40 from memory. She gets stuck at 12. But then she remembers the pattern!

She knows the numbers repeat themselves over and over. From 10 on, there are 2 digits in the numbers. The first digit stays as 1 until 20 and each second digit increases by one. So when she is stuck at 12, she looks back to find the number 2 and sees that it comes before 3, so now she knows to write 13, then 14 then 15 right up to 19. Then the first digit changes to a 2 for 20 and the second digits in the number again increase by 1 each time - 21, 22, 23, etc.

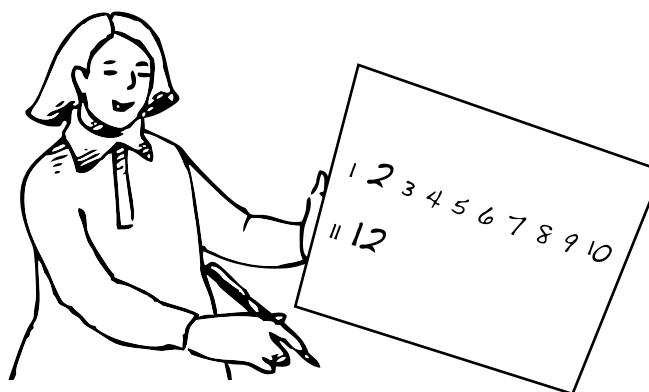

### Kinds of number patterns

In early grades learners experience these main types of number patterns:

#### Repeating patterns

Learners practise a repeating pattern, for example when learning to write rows of the same number:

1 1 1 1 1 1 1 1 1 1 1 1 1

In an example like this one:

1 2 3 4 5    1 2 3 4 5    1 2 3 4 5

the numbers 'grow' or increase in value from 1 to 5, and they are written over and over again. So learners can practice their sequencing skills and their writing skills.

Here are two more repeating patterns:

1 1 2 1 2    1 1 2 1 2    1 1 2 1 2    1 1 2 ...

and

3 4 4 3    3 4 4 3    3 4 4 3 ...

#### Growing patterns

1; 2; 3; 4; ... 100 is a growing pattern.  
The numbers get bigger by one each time.

## Grade 1: Patterns, functions and algebra

100; 99; 98; 97; ... is also called a growing pattern, but this time the numbers decrease by 1 each time.

1; 2; 4; 8; 16; ... is a growing pattern that uses doubling.

16; 8; 4; 2; 1; ... is a growing pattern that uses halving.

### Place value patterns

As learners build their counting from 1 to 100, they will notice that there is a growing pattern in the 10s digits and a cyclical repeating pattern in the 1s digits.

10; 11; 12; 13; 14; ... 20; 21; 22; 23; 24; ...

### Number dot patterns

For each pair or small group of learners, you will need:

Round counters

Copies of the number dot cards (see below)

Sets of number cards from 1 to 10

Learners begin by laying out the dot cards in sequence from 1 to 10.

They then match the dot cards to the correct number cards.

Let learners practise arranging their counters in the same way a few times.

They can then copy the patterns by drawing them in their books.

This is the most common format for arranging dot sequences found in most books and resource materials:

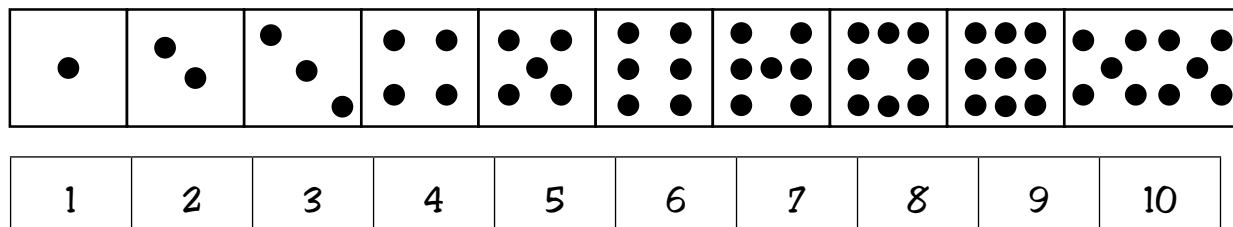

### Bigger number patterns

Learners can use their counters to count out the numbers from 11 to 20. They can arrange them into different patterns of their own. Next ask them to copy the patterns into their books. They can also copy their own patterns or make new ones using peg boards, or by arranging the counters on grid paper. This will help them to organise and show their patterns more easily.

Remember that learners think in different ways.

So, for example, to show patterns for the number 16:

Some learners may line the 16 counters up in two straight rows like this:

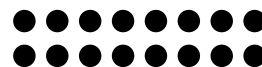

Others may make 4 groups of 4:

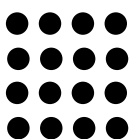

or, an "upside down hat":

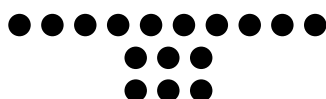

or, "steps":

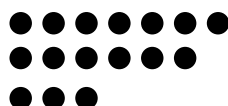

# Grade 1: Patterns, functions and algebra

Make time for learners to talk about and compare their different ways:



## Reflection

Number dot patterns provide learners with opportunities to use a range of mathematical skills:

- They match patterns with numbers and with counters in different arrangements.
- They count and sequence numbers.
- They learn the values, the 'how muchness', of the numbers by counting out and comparing the patterns that different numbers make.
- They learn about conservation of number as they realise that, even if their different arrangements of all the counters in a group do not look the same, the total number of counters in the group remains the same.
- As they create patterns of their own, they develop a sense for grouping, remainders, symmetry, the commutative property of addition, and odds and evens, even if they don't have the vocabulary to describe all these concepts yet.

## Building up and breaking down numbers

### Patterns for 5

For this activity, it is good for learners to work in pairs or even on their own. For each pair of learners, you will need counters of two different colours, grid paper, crayons and number cards.

Learners first use their two colours of counters to make pattern combinations for 5 like this:

○	○	○	○	○	5
●	○	○	○	○	1 and 4
●	●	○	○	○	2 and 3
●	●	●	○	○	3 and 2
●	●	●	●	○	4 and 1

Ask learners to say what each line in the pattern shows. On squared paper, learners can repeat the same pattern, by shading blocks using two different colours:

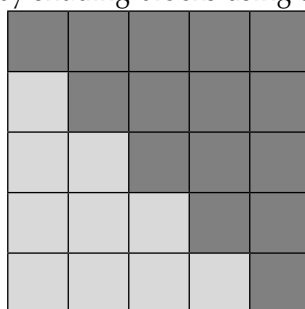

Once they know the + (plus) symbol, they can show the combinations using numbers and symbols:

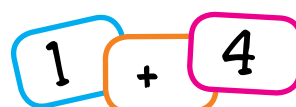

## Grade 1: Patterns, functions and algebra

Then they can write the number combinations next to each row in the pattern:

■	■	■	■	■	■	5
■	■	■	■	■	■	1 + 4
■	■	■	■	■	■	2 + 3
■	■	■	■	■	■	3 + 2
■	■	■	■	■	■	4 + 1

Ask them to find other ways to show the patterns, by shading them in different ways.

For example:

■	■	■	■	■	■	5
■	■	■	■	■	■	4 + 1
■	■	■	■	■	■	3 + 2
■	■	■	■	■	■	2 + 3
■	■	■	■	■	■	1 + 4

■	■	■	■	■	■	1 + 4
■	■	■	■	■	■	2 + 3
■	■	■	■	■	■	3 + 2
■	■	■	■	■	■	4 + 1
■	■	■	■	■	■	5

By working in this way, learners develop a sense of the commutative properties of addition. They realise that even if the order of the numbers to be added changes, their total remains the same.

So for example, from these 2 arrangements, they can see that 4 + 1 makes 5 and that 1 + 4 also makes 5.

■	■	■	■	■	■	4 + 1
---	---	---	---	---	---	-------

■	■	■	■	■	■	1 + 4
---	---	---	---	---	---	-------

### What makes 10?

Learners can then use dots, counters and shading on grid paper to show the combinations they get when they draw or build up 10 in different ways.

○	○	○	○	○	○	○	○	○	○	10
	○	○	○	○	○	○	○	○	○	1 and 9
		○	○	○	○	○	○	○	○	2 and 8
			○	○	○	○	○	○	○	3 and 7
				○	○	○	○	○	○	4 and 6
					○	○	○	○	○	5 and 5
						○	○	○	○	6 and 4
							○	○	○	7 and 3
								○	○	8 and 2
									○	9 and 1

									○	9 + 1
									○	8 + 2
									○	7 + 3
									○	6 + 4
									○	5 + 5
									○	4 + 6
									○	3 + 7
									○	2 + 8
									○	1 + 9
○	○	○	○	○	○	○	○	○	○	10



# Grade 1: Patterns, functions and algebra

By focussing on patterning, we help learners build understanding of number bonds. This is a more powerful approach to mathematical learning and teaching than repetitive rote memory and drill work.

## Patterns in number grids

You will find copies of number grids and blank grids in the Resources Section. Each learner or pair of learners should have their own grid to work with.

### Using blank number grids

- Use blank number boards to identify patterns with the learners.

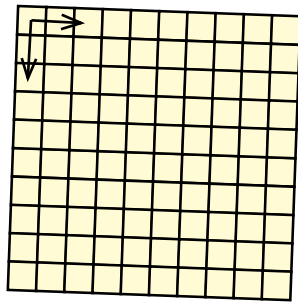

Count the blocks in the first row going across. Say the numbers as you count.



Now count the blocks in the first row going down. Say the numbers as you count.

Now do the same for the second and third rows across and down. What did you notice? There are always 10 blocks across and 10 blocks down. And to find how many blocks there are altogether, we can count on in 10s. Let's do that!



Learners can then count 10, 20 30, ..., 100 pointing to the rows in the grid as they count.

- Now ask learners to count each block from 1 to 100 and place a counter on the 10s number at the end of each row. They place the corresponding 10s card next to each blocks they cover. They will see a pattern that looks like this:

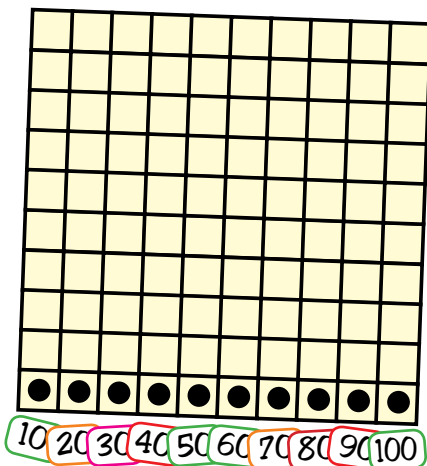
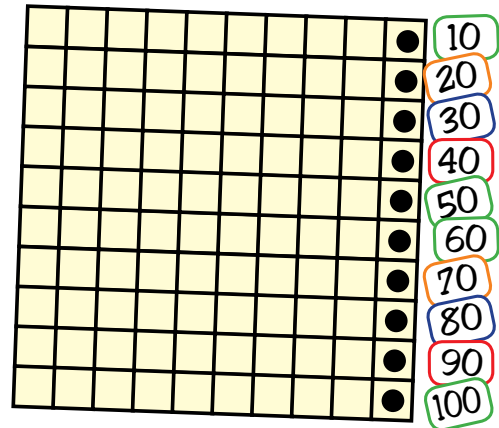

- Let them do the same, but this time counting down the columns, so that they have this pattern:

**Other ways to count from 1 to 100**

Let learners investigate what pattern they will get if they count in the direction shown here, placing a counter on every 10<sup>th</sup> number. This is the way that the board for Snakes and Ladders is usually organised, so you could use the Snakes and Ladders board for this activity.

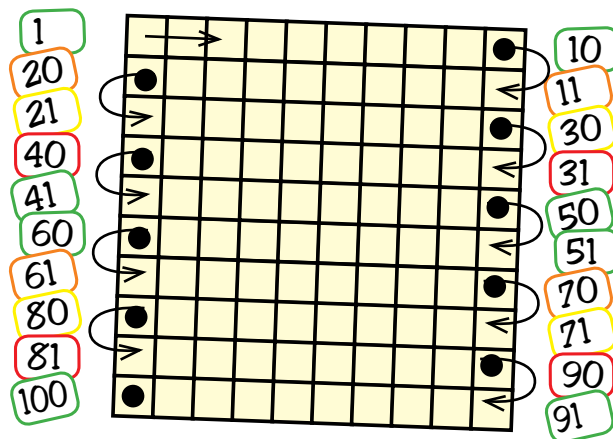
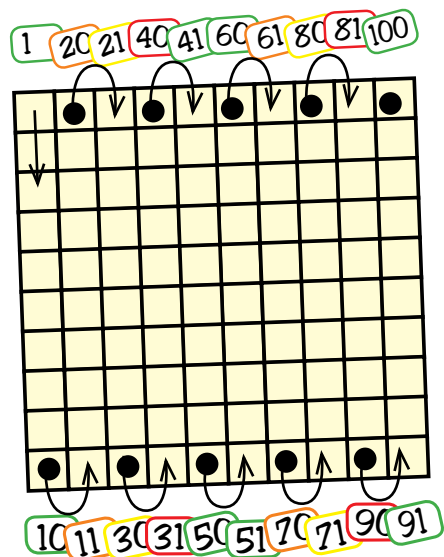

You can also start by going down the board and back up the next column.

**Using the 1 to 100 number board**

- Ask learners to point to, or place a counter on, each number as they count forwards and backwards. Putting out the counters like this helps learners get a sense of the actual size of the numbers.
- They also see that each number is one more than the previous number as they go forwards, and one less as they go backwards.
- Start with small numbers and let learners build up a solid understanding of the sequence.
- When they come to the end of a row, help them to count on from the beginning of the next row, rather than going back to 1 again.

1	2	3	4	5	6	7	8	9	10
11	12	13	14	15	16	17	18	19	20
21	22	23	24	25	26	27	28	29	30
31	32	33	34	35	36	37	38	39	40
41	42	43	44	45	46	47	48	49	50
51	52	53	54	55	56	57	58	59	60
61	62	63	64	65	66	67	68	69	70
71	72	73	74	75	76	77	78	79	80
81	82	83	84	85	86	87	88	89	90
91	92	93	94	95	96	97	98	99	100

During number board activities, ask guiding questions to draw learners' attention to the grouping and counting patterns, for example, ask questions like:



Learners should be able to explain which digits stay the same across the rows, which digits stay the same down the rows and which digits go up by 1 each time.

# Grade 1: Patterns, functions and algebra

## Shading number board patterns

Ask learners to shade all the blocks that have a 1 in them. Talk about the pattern they get. They should leave out the number 100.

1	2	3	4	5	6	7	8	9	10
11	12	13	14	15	16	17	18	19	20
21	22	23	24	25	26	27	28	29	30
31	32	33	34	35	36	37	38	39	40
41	42	43	44	45	46	47	48	49	50
51	52	53	54	55	56	57	58	59	50
61	62	63	64	65	66	67	68	69	70
71	72	73	74	75	76	77	78	79	80
81	82	83	84	85	86	87	88	89	90
91	92	93	94	95	96	97	98	99	100

1	2	3	4	5	6	7	8	9	10
11	12	13	14	15	16	17	18	19	20
21	22	23	24	25	26	27	28	29	30
31	32	33	34	35	36	37	38	39	40
41	42	43	44	45	46	47	48	49	50
51	52	53	54	55	56	57	58	59	50
61	62	63	64	65	66	67	68	69	70
71	72	73	74	75	76	77	78	79	80
81	82	83	84	85	86	87	88	89	90
91	92	93	94	95	96	97	98	99	100

Using a different colour, learners can shade all the numbers that have a 2 in them.

Ask them to predict what the pattern will be for all the numbers that have a 3 or a 4. They must then shade their patterns to test their predictions.

## Skip counting on the number board

When learners can read and sequence numbers from 1 to 100, they can use the number board to explore the patterns for skip counting in 2s, 3s, 4s, 5s and 10s. They can count on in different number groups and shade the blocks as they count. Then they can talk about the patterns they see.

### For the 10s pattern

1	2	3	4	5	6	7	8	9	10
11	12	13	14	15	16	17	18	19	20
21	22	23	24	25	26	27	28	29	30
31	32	33	34	35	36	37	38	39	40
41	42	43	44	45	46	47	48	49	50
51	52	53	54	55	56	57	58	59	50
61	62	63	64	65	66	67	68	69	70
71	72	73	74	75	76	77	78	79	80
81	82	83	84	85	86	87	88	89	90
91	92	93	94	95	96	97	98	99	100

### For the 5s pattern

1	2	3	4	5	6	7	8	9	10
11	12	13	14	15	16	17	18	19	20
21	22	23	24	25	26	27	28	29	30
31	32	33	34	35	36	37	38	39	40
41	42	43	44	45	46	47	48	49	50
51	52	53	54	55	56	57	58	59	50
61	62	63	64	65	66	67	68	69	70
71	72	73	74	75	76	77	78	79	80
81	82	83	84	85	86	87	88	89	90
91	92	93	94	95	96	97	98	99	100

**For the 2s pattern:**

1	2	3	4	5	6	7	8	9	10
11	12	13	14	15	16	17	18	19	20
21	22	23	24	25	26	27	28	29	30
31	32	33	34	35	36	37	38	39	40
41	42	43	44	45	46	47	48	49	50
51	52	53	54	55	56	57	58	59	60
61	62	63	64	65	66	67	68	69	70
71	72	73	74	75	76	77	78	79	80
81	82	83	84	85	86	87	88	89	90
91	92	93	94	95	96	97	98	99	100

Ask learners to tell you about the different patterns. For example:

What digit do the numbers in the 10s pattern end with?

Which numbers are in more than one pattern? What digits do the numbers in the 5s pattern end with? ... the 2s patterns? ... the 4s pattern?

Which numbers are in the 2s pattern and the 3s pattern and the 4s pattern?

**Grouping patterns**

Give learners a pile of counters. They can start with 10 counters. Ask them to see how many times they can put out 2 counters, one under the other. Ask them to describe their pattern.

Let them then take 12, 15, 20 or even up to 30 counters, and find different ways to arrange them in group patterns, with the same numbers of counters in each group. Again make time for them to discuss and share the different patterns they make.

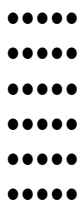
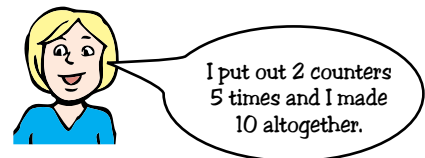

I counted out 30 counters. I made a pattern using 5 counters in a row. There are 6 rows in my pattern.



I also counted out 30 counters. My pattern has 10 counters in a row. There are 3 rows in my pattern.



After working with counters, learners can then shade blocks to build different kinds of group patterns in the same way.

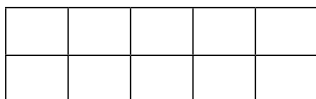

My pattern has 2 rows with 5 blocks in each row.

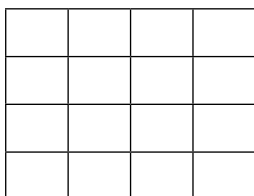

My pattern has 4 blocks in a row. I made 4 rows.

## Grade 1: Patterns, functions and algebra

### Growing number sequence patterns

Make work cards with different examples of number sequence activities. Work cards are useful because you can adapt the text book activities to meet your own learners' needs. You can also design work of different difficulty for learners who are functioning at different levels. Learners can also choose whether they need the support of concrete aids to help them complete the work cards, or whether they are able to work mentally.

Here are examples of the kinds of worksheets or work cards you can design to reinforce your learners' skills with counting forwards and backwards from any number and for looking for patterns.

According to the needs of your different learners:

- make the worksheets shorter or longer;
- use bigger or smaller numbers;
- use other patterns.

#### Counting forwards

Look at these rows from a number board. Some numbers are missing. Write the missing numbers.

1.

		3		5				9	
11			14						

2.

		33		35				39	
41			44						

3.

	72						78		
			84						

4.

1		3		5		7		9	
11		13		15		17		19	
21		23		25		27		29	
31		33		35		37		39	

Talk about patterns. What patterns do you see in this set of numbers?

Learners should be able to explain that the digits in the 1s place are the same across the rows, while the (value) of the 10s digits increases by 1 down the rows.

#### Counting backwards

Look at these rows from a 'backwards' number board. The numbers go backwards. Write the missing numbers.

1.

20	19	18		16					11
		8				4			

2.

40				36					31
	29			26					
									11

3.

60		58		56		54		52	
50		48		46		44		42	
40		38		36		34		32	

Ask learners to complete work cards such as these and then describe the patterns.

10 + 1 =	20 + 1 =	30 + 1 =
10 + 2 =	20 + 2 =	30 + 2 =
10 + 3 =	20 + 3 =	30 + 3 =
10 + 4 =	20 + 4 =	30 + 4 =
10 + 5 =	20 + 5 =	30 + 5 =
10 + 6 =	20 + 6 =	30 + 6 =
10 + 7 =	20 + 7 =	30 + 7 =
10 + 8 =	20 + 8 =	30 + 8 =
10 + 9 =	20 + 9 =	30 + 9 =
10 + 10 =	20 + 10 =	30 + 10 =

Here they should see that the (value of the) 1s digit remains the same across the 3 patterns while the (value of the) 10s digit increases by 10 each time.

**Repeating patterns**

Give learners examples that repeat numbers in a particular sequence to help them get a sense of repeating patterns.

1; 2; 1; 2; \_; \_; \_; \_

3 5 5 3    3 5 5 3    3 □ 5 3    3 □ □ □    □ □ □ 3

**Vocabulary**

**Grade 1, 2 and 3:**

Repeating pattern; language to describe patterns, e.g. position words - right, left, first, second, last, next, the one before, the one after; shape and colour words; increase or grow, decrease or shrink; doubling; halving; rows and columns.

**Resources**

Pictures of patterns in nature, in drawings, clothes, paving, houses etc; pattern posters if possible; musical instruments to make rhythm patterns; cut-out shapes for making patterns; beads, seeds, threading string etc; potato prints or stencils; paints; glue and scissors; coloured paper; counters; number dot cards; number cards; grid paper; number boards and blank number boards; weather charts, timetables, life cycle charts etc; grids, wrapping paper or wall paper.

# Grade 1: Shape and Space (Geometry)

The learner will be able to describe and represent characteristics and relationships between two-dimensional shapes and three-dimensional objects in a variety of orientations and positions.

## Skills and knowledge

### The learner:

- Recognises, identifies and names two-dimensional shapes and three-dimensional objects in the classroom and in pictures including: boxes (prisms) and balls (spheres); triangles, rectangles; circles.
- Describes, sorts and compares physical two-dimensional shapes and three-dimensional objects according to: size; objects that roll or slide; shapes that have straight or round edges.
- Observes and builds given three-dimensional objects using concrete materials (e.g. building blocks and construction sets).

The vocabulary that learners need to understand and use is listed at the end of the suggested activities. You will find it helpful to make flash cards with key vocabulary words to support the teaching and learning process. A list of the resources you will need for the activities is also provided. ([See Resources](#))

## Suggested activities

### 1. Introducing 3-D objects

#### Shape walk

Take learners on a 'shape walk' around the school grounds to look out for and identify the shapes of different objects around them. Ask questions that help them to describe their different features or properties.

For example: Which are taller than others? Which are wider than others? Which are round or flat? Which of them have corners or points? Which are curved? Which are straight? Which are solid? Which are hollow? Which can roll and which cannot? Which keep their same shape from top to bottom? Which get wider or narrower at the top?

Where possible, learners must test their ideas by picking up, turning and rolling objects.

#### Sliding and rolling

Do outdoor activities where learners physically experience **sliding** and **rolling** with their bodies and with different objects like boxes and balls. Talk about what makes it possible for some objects to roll and why others can't. Encourage them to use words like curved, round; straight, pointy corners; no corners.

#### Sorting boxes

Give each group of learners a collection of 3-D objects and ask them to sort them into two groups. For example, put all the objects that are round or curved like a ball together in one group and others with straight edges and corners in another. Or they could put all the solid objects in one group and the hollow (or 'empty') objects in another.





## Making models

Make play dough or give learners plasticine and ask them to make models of different shaped-boxes (prisms) and balls. Test to see which objects can roll. Ask what learners must do to make the other shapes move (slide them along).

## What would happen?

Ask questions like: "What would happen if a ball were shaped like a cube?" "What would happen if you tried to bounce it?" "Why are bicycle wheels round?" "What would happen if they were square?" "What would it be like to sleep on a round instead of a rectangular bed?" "What is the difference between a round room like a traditional hut and a square or rectangular room with corners?" "Where possible, let learners test their ideas."

## Guess the object

Cover different solid shapes with a cloth. Ask learners to feel them and guess what kind of objects they are and say as much as they can about them, including whether they roll or slide.



Use the same collection of objects. Let learners investigate which of the shapes they can stack on top of each other and which they can't. Let them explain why this is so.

## 2. Introducing 2-D shapes

### 2-D shape activities

This is a sequence of steps for building the learners' understanding of 2-D shapes in a progressive way. You can also select the activities that are suitable for your class.

#### Step 1:

Begin by letting learners freely explore the similarities and differences between different 2-D shape cut-outs or plastic shapes, before introducing them more formally to their different names and properties.

#### Step 2:

Give a set of coloured cardboard, plastic or wooden shapes to each group of learners to sort. First let them find their own ways to do this. Ask them to explain how they did this.

#### Step 3:

Next give them instructions for how you want them to sort the blocks. For example:

- Sort them into three groups - all the shapes with straight sides, all the shapes with curved sides, all the shapes with both curved and straight sides (like semi-circles).
- Put shapes of the same kind together (all the triangles, circles, rectangles).
- Arrange groups of the same shape according to size - small or big triangles; narrow or wide rectangles.

#### Step 4:

Next help learners to think about the different properties or attributes by asking them, for example, to find a shape from their set of shapes that has:

- all four sides the same length;
- three straight sides and three corners;

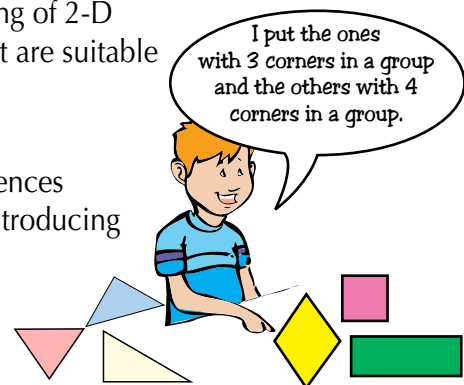

See Resources, p371, for examples you can copy for your learners.

## Grade 1: Shape and Space (Geometry)

- two long sides and two short sides;
- one round edge and one straight edge (a semi-circle);
- four sides but not a rectangle (this could be a rhombus, trapezium or parallelogram)
- no corners.

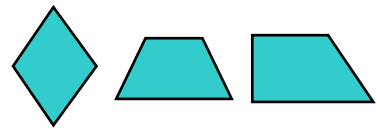

**Note:** Even though it is expected that learners in Grade 1 only become familiar with the properties of rectangles, triangles and circles, sets of bought shapes generally include rectangles, squares, hexagons, trapeziums, rhombuses, circles and semi-circles. Learners can work informally, to uncover and compare the properties of all the shapes in their set using attributes like: number of sides, if these are the same or different, round or curved.

### Step 5:

Prepare worksheets to reinforce the ideas above. For example, make copies of different shapes and ask learners to colour the shapes with curved sides red; the ones with straight sides blue; the ones with both curved and straight sides green. Or they could colour the four-sided shapes one colour and the three-sided shapes another colour.

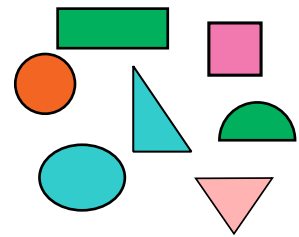

### Step 6:

You can now focus on the mathematical names we give to the shapes that Grade 1 learners are expected to know and distinguish between. These are: a triangle, a rectangle and a circle. We suggest you also include a square. Gradually learners will be able to distinguish the difference between a square and a rectangle on their own. Remember that a square is also a rectangle, but a special kind that has all four sides the same length! To help them find differences between a square and a rectangle, they can turn the squares around to show that a square looks the same any way you turn it, but a rectangle will look different.

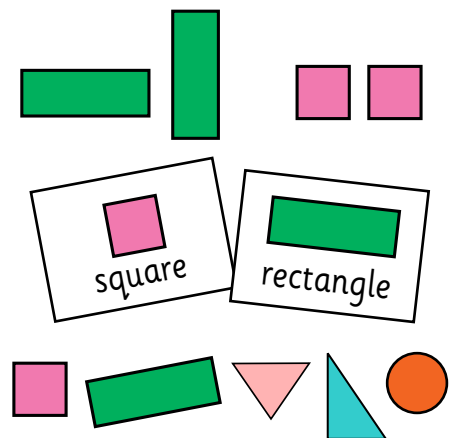













### Step 7:

Make large cardboard templates of these shapes to display on the classroom walls with labels for each one, written in big clear lower case letters. Pin them on the board or on the classroom walls where all learners can see both the shape and the letters making up the words.

### Step 8:

Prepare a set of cardboard shapes made up of different sized circles, triangles and rectangles, including squares. Hold them up at random and ask the learners to name them. Introduce the terminology 'edges' and 'corners' and show learners how we can count round the edges and corners to find, for example, that a triangle has three straight edges and three corners, or a circle has one curved edge, or a rectangle has four straight edges and four corners.

square	    
rectangle	   
circle	   

### Step 9:

Ask learners to now sort their shapes into triangles, circles and rectangles. Let them then build rows or columns with their shapes to make a concrete graph, showing how many of each kind they have. Give them number cards to place at the end of each row or above each column. Ask guiding questions. For example,  
 "How many more circles than triangles do you have?" or,  
 "How many more rectangles than circles do you have?"

## Grade 1: Shape and Space (Geometry)

### Step 10:

Prepare a worksheet with different kinds of triangles, rectangles and circles and have learners colour each kind of shape the same colour and match them to the correct names.

### Step 11:

Make another worksheet in which you draw a selection of 'pointy-like' shapes, some of which are triangles and others which are not. Ask learners to mark all the triangles and explain why the other shapes are not triangles..

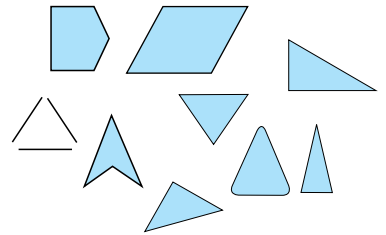

## More shape activities

### Making body shapes

Have learners lie down on the ground and arrange themselves to form different shapes. For example, three children can lie down to form a triangle or four children of the same height can make a square, or two pairs of children of the same height can form the opposite sides of a rectangle. They will have fun finding out for themselves which learners are of the same height to be able to make different-sized rectangles, squares and triangles. Encourage learners to predict how many learners they will need to make each of the different shapes.

### Walk the shape

Hold up a shape. Let the learners describe its parts. Then ask one learner to 'walk the shape'. As he/she walks, another learner can follow behind and draw the path taken, with a stick on the ground. Learners can discuss whether the path is the same or different from the shape that you held up.

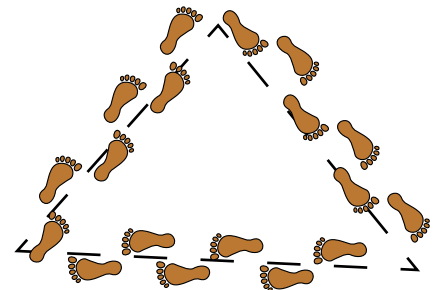

### String shapes

Give out different lengths of string or rope to each group of learners and ask them to form different sized triangles and rectangles. They must work out how many learners need to hold the string for each corner they make. Ask questions like: "For a triangle to be called a triangle how many sides must it have? Must the sides always be the same length? Must they always be straight?" Do the same for rectangles.

Learners can then walk around each of the different shapes and discuss and compare their sizes and shapes. Let them find out, for example, which of the triangles have sides of the same length or which of the rectangles have sides of the same length.

### Feel the shape

Put a collection of shapes in a bag. Learners take turns to choose a shape without looking at it. They must decide what shape they have chosen and describe and name it to the rest of the group. Vary the game: let learners play in their groups or let them take turns to pull a shape out of the bag, and ask the other members of the group to name and describe it as accurately as possible, e.g. "It is a triangle with all three sides the same length" or "with two sides the same length and one side longer than the others".



### Shape riddles

Give learners different shape riddles to solve like: "I have three corners and three sides. What am I?" (triangle) "I have one round side and one straight side, what shape am I?" (semi-circle). They can then make up their own riddles to ask one another in their groups.

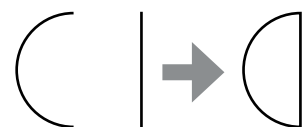

# Grade 1: Shape and Space (Geometry)

## Hidden shapes

Use a piece of cardboard supported on the desk so that it forms a screen between you and your learners. Choose a shape without letting them see it and show only a tiny part of it above the screen (an edge or a corner). Ask learners to guess what shape it might be and to say why they think so. If they cannot guess, lift the shape to reveal a larger part of it. Learners can also play this game in pairs, taking turns to hide different shapes.

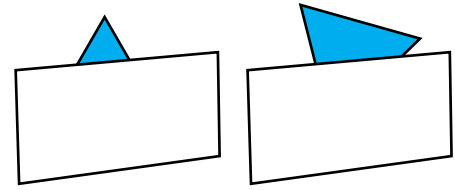

## 3. Moving from 3-D to 2-D

This is a sequence of activities.

### Step 1:

Use the same assortment of boxes and blocks you used for previous 3-D investigations. Include examples of squares, triangular prisms and cylinders.

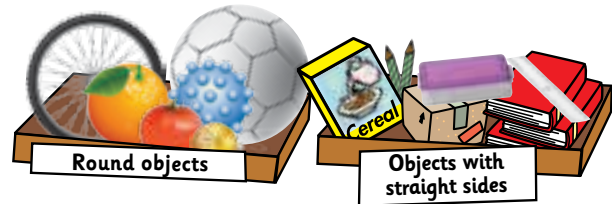

Give each group their own set of boxes and blocks to work with. Make sure there are a variety of different types in each set. This time let learners describe and compare the boxes according to the shapes of their faces. Show them what we mean by the face, by pointing to the flat sides that we see when we look at the boxes face on. Point out different examples like the circular face of a cylinder, the triangular face of a triangular prism or pyramid, the rectangular and square faces of different blocks and boxes.

### Step 2:

Learners can then work in pairs to investigate one object at a time looking for all the different shaped faces they can find on each example. Make time for them to discuss and compare their findings with the rest of their group members.

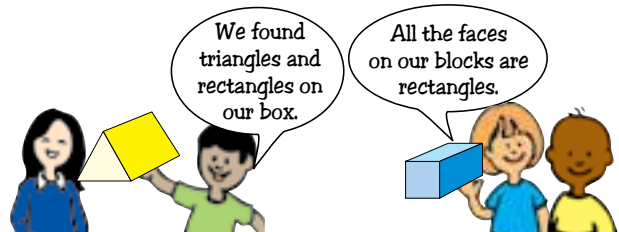

### Step 3:

Ask each group to show you a box or block from their set that has:

- only rectangular or square faces - let them count the number of faces;
- both triangular and rectangular faces (a triangular prism);
- only triangular faces, for example, a triangular based pyramid or tetrahedron;
- one or two circular faces (open or closed cylindrical box or block).

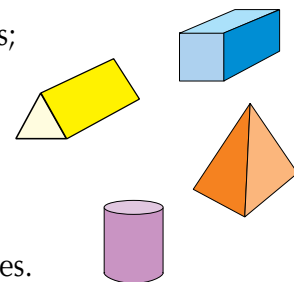

Each learner can then choose one block or box and trace around its faces.

### Step 4:

Learners study an object. They use the same colour to shade all the faces that are the same shape. They can then name the faces either by telling you their names, or by copying the names from the labels you have on the board or classroom walls.

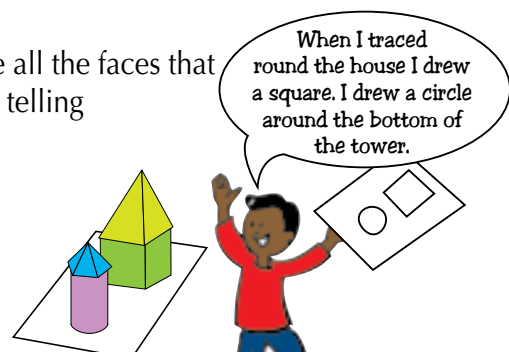

## Step 5:

Now ask learners to look around the classroom or take them outdoors to look for objects that have the same kinds of faces as the ones they investigated. For example, a circular light, cylinders or cups, a rectangular shaped window or door, triangular wood trusses.

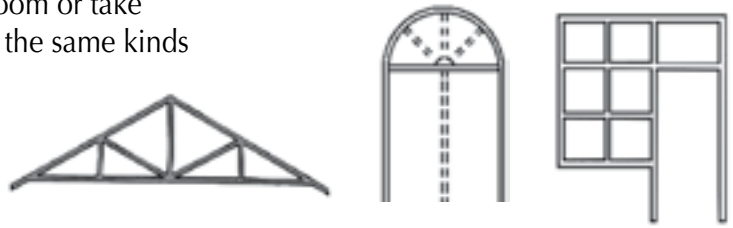

## 4. Building and constructing models with 3-D materials

### Building:

Ask learners to collect more blocks, boxes and containers of different shapes from home. Use these, or ready-made construction sets, to let learners build 3-D models. Ask them to describe their models and explain the different shapes they used.

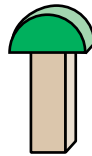

The top of my tree is a semi-circle, the trunk is a thin rectangular block.



I made my house using a square block for the bottom part and a pointy block for the roof.



### Following building instructions

- Give learners building instructions or plans to follow. For example:
  - “Make a house that’s 3 blocks high and 5 blocks across and find a way to give the house a pointed roof.”
  - “Use as many blocks as you can to make ‘trains’ of the same length and size.”
  - “Build a tower as high as you can, using as many of the blocks or boxes as you can. Make sure your model does not fall over.”
- Ask learners to describe their constructions each time and to say which kinds of blocks they used to make them.
- Use multilink blocks or similar construction blocks that join on each side. Make a shape yourself using four or five blocks and keep it hidden from the learners. Give each learner the same number of blocks for them to build a copy of your model.
- Explain how you made your shape block by block. For example, “Take a blue cube. Put a green one on top of it. Put a red block to the right of the top blue one. Put a yellow block behind the blue one.”
- When they have finished, let them compare their models to yours.
- Learners can then work in pairs. They take turns to make a shape then hide it and explain step by step to their partner what it looks like. Their partner must then try to copy it.

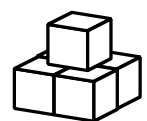
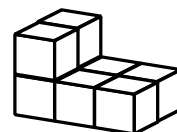
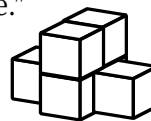
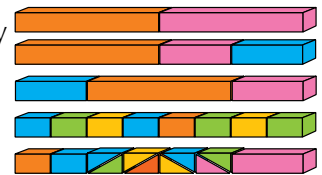

## 5. Expanded opportunities: Building 2-D shapes

Note: Grade1 learners will enjoy and benefit from constructing shapes and designs with 2-D shapes in the ways we suggest below.

### Shape pictures

You will need sets of plastic, wooden or cardboard shapes for groups or pairs of learners. Learners first work freely, to find out for themselves how they can join different shapes to build new shapes and to make shape designs and patterns.

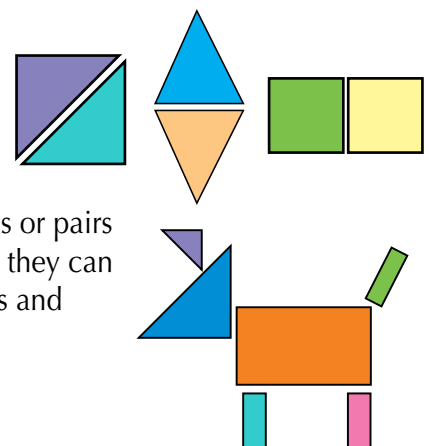



## Grade 1: Shape and Space (Geometry)

- Ask them to build different pictures using their pieces, e.g. a tree, a house or a cat.
- Give them more guided instructions. For example: "Make the biggest rectangle you can with your pieces."

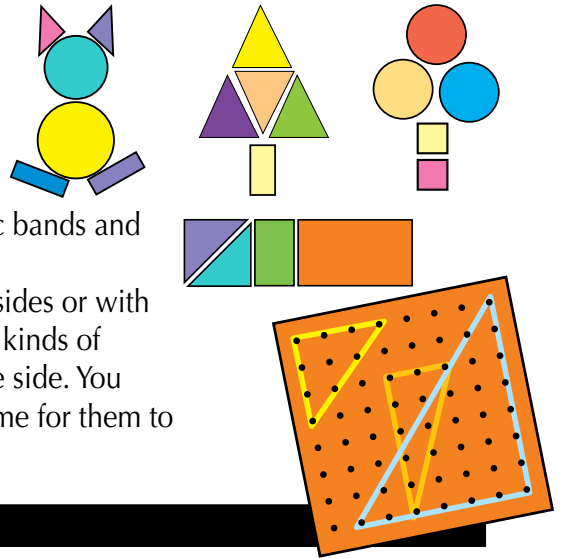

### Peg boards and geoboards

Give each pair of learners peg boards or geoboards with elastic bands and show them how they can form different 2-D shapes with these.

Ask them to make a rectangle with two long sides and 2 short sides or with all sides the same length (a square). Or they can make different kinds of triangles with their points facing upwards, downwards or to the side. You can draw examples on the board for learners to copy. Make time for them to discuss and compare the different shapes they made.

## Skills and knowledge

### The learner:

- Recognises symmetry in self and own environment (with focus on left, right, front and back).

## Suggested activities

### Exploring symmetry

**Note:** Symmetry is more easily understood if compared to non-symmetry. Learners must realise that symmetry is different from 'the same as', e.g. two identical wings of a butterfly are **the same** but a right and a left wing are **symmetrical**.

#### Left and right

Sing songs, recite rhymes and play games to help learners learn left and right. For example, *Do the hokey pokey, put your left hand in, put your right hand out... stamp your left foot, etc.*

#### Using a mirror

Let learners stand in front of a mirror. Find the midline that divides their bodies into two symmetrical halves. They can then hold a metre stick or straight piece of thin wood down their midlines to show how the midline divides the left and right sides of their bodies into two symmetrical halves.

They should discover that while the left side of the body is symmetrical to the right, the top of their bodies is not symmetrical to the bottom and the front is not symmetrical to the back. Ask them to also look for symmetry in the way their eyes, noses and mouths are formed.

#### Body symmetry

Give large sheets of newsprint or newspaper and a coloured crayon to each learner. Let them trace around one another's outlines. They can then try to fold the outlines down the middle to see how the two parts fit on top of each other. They can then draw in the fold lines to show the vertical line of symmetry. Point out that they can cut out and fold pictures and drawings down the middle to check for symmetry. If the one half of the shape fits exactly over the other half, we say the shape is symmetrical.

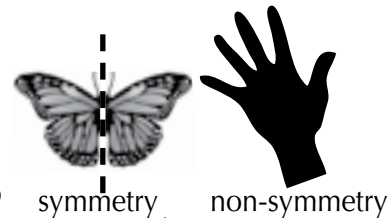

One, Two, Three, Four, Five  
One, two, three, four, five,  
Once I caught a fish alive.  
Six, seven, eight, nine, ten,  
But I let it go again.  
Why did I let it go?  
Because it bit my finger so.  
Which finger did it bite?  
The little one upon the right.

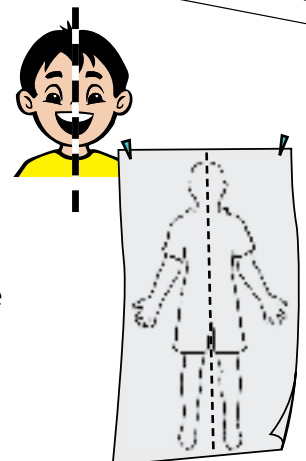

# Grade 1: Shape and Space (Geometry)

## Object symmetry

- Help learners to identify symmetry in objects around them, e.g. a doll or toy car (left and right are symmetrical but not top and bottom or front and back). A square block or box is symmetrical both across and up and down.
- Bring examples of cultural artefacts or pictures of these for learners to observe symmetry e.g. pots, hats, beadwork, traditional huts or wall designs.
- Show learners some examples of symmetry in natural objects like leaves, seedpods and flowers.

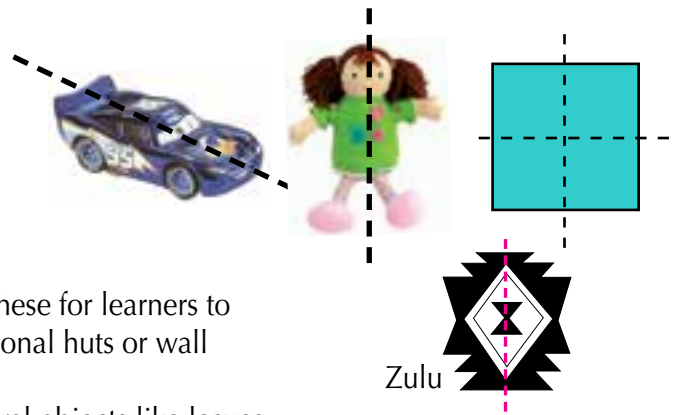

## Sorting by symmetry

Take learners on a nature walk around the school grounds. Let them collect different kinds of natural objects. Back in class have them sort these into groups to show which have symmetry and which do not. Make time for learners to talk about the groups and the different objects in relation to symmetry and asymmetry.

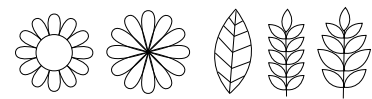

## The other half

Make worksheets using drawings of natural objects, everyday objects and designs. Draw in half the shape, either vertically, horizontally or diagonally. Learners must draw in the other half.

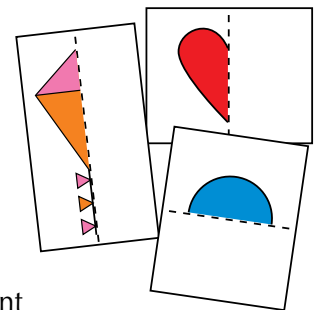

## Cutting objects

Cut various objects, e.g. apple, orange, banana, slice of bread, etc. in different ways to illustrate when the cut is symmetrical and when it is non-symmetrical. Once you have done this once or twice, ask learners to predict if they think the two pieces of another kind of fruit or vegetable will be symmetrical if you cut them in a particular way.

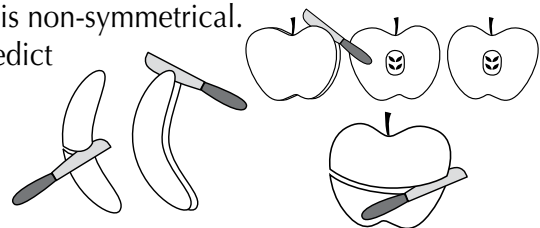

## Symmetry in patterns and designs

Show learners a symmetrical pattern made with shapes and an asymmetrical pattern. Then prepare some practical activities where learners have the opportunity to create their own symmetrical designs.

- **Shape patterns:** Give learners plastic shapes or gummed paper shapes to create symmetrical designs. Let them assess each other's designs to check if they are symmetrical or not.
- **Painting:** Give each learner an A4 page and some paint. First they fold the paper in half, and unfold it again. They then put a blob of paint on the fold, fold again, rub the paper smoothly together and observe the symmetry of the design on either side of the fold line.
- **Beading:** Make up two examples of bead necklaces, where the one is symmetrical and the other is not, or draw pictures of these on the board. Ask learners to say which necklace has symmetry and which does not and to say how they know.



Has symmetry

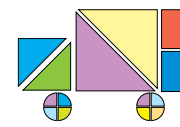

Not symmetrical

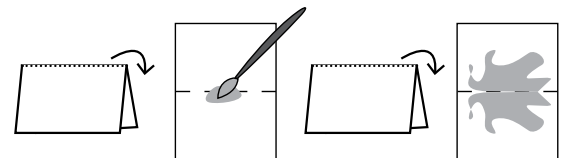

Non symmetry

Give each pair or group of learners their own beads and thread to make up examples of both symmetrical and asymmetrical bead designs. If you do not have beads, they can also make necklaces from different kinds of pasta. They could paint these in different colours beforehand in an Art lesson.

This necklace has symmetry because I can see that there is a big round bead in the middle and on both sides of that there is a diamond, then a square, then a circle.

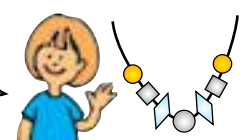



## Grade 1: Shape and Space (Geometry)

### Symmetry in 3-D models

- Collect blocks or boxes and other anti-waste materials for learners to build 3-D symmetrical models. Make up two examples yourself to show them - one that is not symmetrical and one that is where you can point out the matching pairs of shapes on either side of the middle line.

## Skills and knowledge

### The learner:

- Describes one three-dimensional object in relation to another (e.g. 'in front of' or 'behind').
- Follows directions (alone or as a member of a group or team) to move or place self or three-dimensional objects in relation to each other.

## Suggested activities

### Position and direction inside the classroom

#### Identifying position

Place different objects on a sheet of paper or draw pictures in different positions on the board. Ask learners to say where these are in relation to each other. For example: in the middle, near the middle, at the top or bottom, to the side, at the edge.

#### Arranging objects

Give learners instructions to arrange objects on their desks or on the floor in different ways.

For example: "Put the pencil in the centre; place the book to the right of the pencil and the box to the left of the book. Put the ruler underneath the pencil."

#### Beanbag position

Give learners beanbags. Ask them to place the beanbag 'to the left of' the chair, 'inside' the bag, 'underneath' the chair. Let learners then take turns to place their beanbags in different positions. Ask them to describe the positions. For example: "I am putting the beanbag on top of my book, next to my chair, on the floor."

#### Directing people

- Learners work in groups. Give them instructions to move themselves into different positions: "Stacey, stand next to Amy", or "Paul, stand two places in front of Hannes".  
Ask them to describe their positions in more than one way. For example: "I am standing behind Tshepo but in front of Zami. Khaya is on my right and Johannes is on my left."
- Give learners instructions to move around to different positions in the class. For example: "Go to the front or back of the class. Girls, stand on your chairs, boys sit under your tables."
- Clear some space in the classroom and have learners follow your instructions. For example, "Move three steps forward, then two steps to the right. Now take four steps back and two to the left." Repeat the instructions in reverse so learners arrive back at the point they started from.
- Extend the challenge by giving learners 'stage directions' For example: "Stand to the right of the box... The chair must be behind the table from

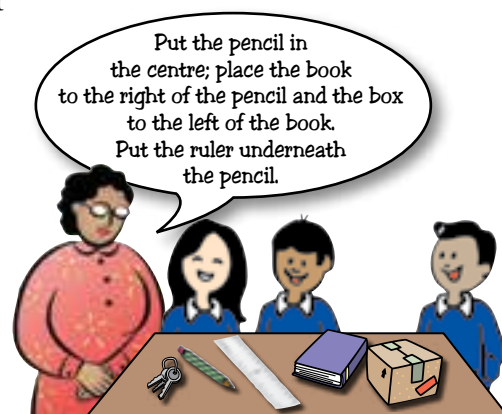

where you are standing. Move to a place where you see the chair in front of the table.”

- Ask learners to explain to the class the route they have to follow, e.g. “To get to the door, you must turn around, walk forward 10 steps, turn left, walk forward 5 steps, open the door.”

### Stories and rhymes

Find examples of stories and rhymes that use positional terms, such as: on, over, under, near, far, in front of, behind, to the side, between, left and right. Let your learners act out the stories as they use the terms to describe what they are doing. You can use your classroom furniture as props so that, for example, children show and describe how they go over or under the “bridge” or through a “tunnel”.

### Position in pictures

Use pictures from books and magazines or classroom posters. Discuss how we represent position in drawings. For example: “Who is in front of the cat? Who is next to the cat? Who is far away from the cat?” Start with simple pictures and then find more complex ones with more detail and possible positions and locations that they must describe.

### Drawing position

Give each learner a sheet of grid paper and some crayons. They must follow your instructions, like: “Draw a red circle in the top left corner, draw a blue triangle in the bottom right corner or draw a yellow square in the middle.”

Ask learners to draw their own pictures to illustrate positional terms. For example, “Draw your friend standing under a tree” or, “Draw a cat standing between the tree and the house” or, “Draw a ball in Tumi’s right hand”.

### Moving the arrow

Construct a cardboard circle with a moving arrow. Ask different learners to come up to the front and move the arrow in different directions, e.g. down, to the right, to the left. The rest of the class must show the direction that the arrow moves using their hands.

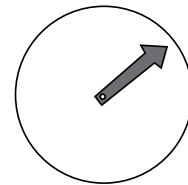

## Outside activities for position and direction

### Follow instructions

Learners follow instructions like climb upwards, downwards, towards, away from, across, along, through, turn to the left, to the right, move forwards, backwards and sideways, face towards the field, away from the field.

### What do you see?

Ask the learners to face in a specific direction, and say what they see when they look straight ahead. Then ask them to turn around (180 degrees) and say what they see now. Then ask them to make a quarter turn and say what they see now, and then another quarter turn, back to where they started.

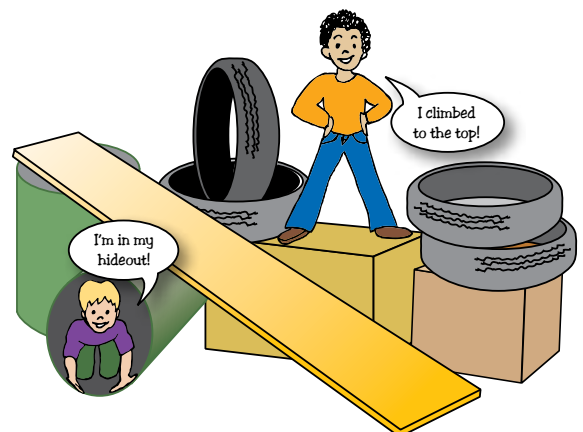

## Grade 1: Shape and Space (Geometry)

### Obstacle course

Create an obstacle course outdoors that learners must follow by listening to the instructions you give them. For example, "Jump over the tyres, climb through the hoop, slide down the slide; climb up the stairs of the slide, go to the left of the jungle gym." Learners should verbalise what they are doing, using the relevant vocabulary.

Learners can also create their own obstacle course and give instructions for their peers to follow. For example, "Climb over the tyre, walk on the beam, and climb through the hoop."

### Describe position

Discuss the positions of objects in the environment, e.g. "Where is the red car? (Between the white car and the blue car) etc. Ask enough questions to ensure that all the key words of position have been covered.

### Follow my leader

Let one learner be the leader. The other learners must copy his/her movements as they follow what the leader does. The leader should move into different positions and in different directions.

### Sand drawings

Learners draw in the sand as they follow a given set of instructions. For example: "Draw a straight line going down; draw a straight line to the right; draw a straight line up; draw a straight line to the top/bottom corner." Then ask them to describe the shape they drew. They can repeat the same kind of activity on paper using wax crayons.

## Vocabulary

Note: If you do not teach in English, use equivalents in your language of instruction.

### Grade 1:

Understand and use these words in practical contexts:

- shape, pattern, flat, curved, round, straight
- solid, corner, face, edge
- rounded, pointed
- roll, slide
- build
- everyday language to name and sort properties of 3-D objects and 2-D shapes such as cubes, spheres, circles, triangles, rectangles (squares)
- front, back, right, left, midline
- top, bottom, across, up and down, from side to side
- down the middle, across the middle, midline
- reflect, mirror, dotted line, equal parts or halves.
- in front of, behind, side, next to, beside, on top of, above, underneath, below, inside, outside, to the left of, to the right of, left hand side, right hand side
- to, from, towards, away from, over, under, underneath, above, below, on, in, outside, inside, in front, behind, beside, before, after, next to, opposite, between, close by, far away, far apart, middle, centre, edge, corner, sideways, up down, forwards, backwards, across, along, around, through.

### **Grade 2 - add the following to the Grade 1 vocabulary:**

- rectangular, triangular
- squared prisms
- a square is a special kind of rectangle with all sides the same length
- a square prism, a rectangular prism and a triangular prism
- other names of shapes that they may come across like rhombus (diamond), hexagon, trapezium or kite
- tangram
- symmetry, symmetrical, non-symmetry, non-symmetrical
- views from the front, from the back, from the sides, from the top, position, view, changes, looks different.
- quarter turns, half turns, full turns, clockwise, anti-clockwise.

### **Grade 3 - add the following to the Grade 1 and 2 vocabulary:**

- balance, not balanced, facing opposite directions
- vertical, horizontal, diagonal
- map, point, distance, aerial view, floor plan
- area, perimeter

## **Resources**

- 3-D blocks of different shapes and sizes including:
  - cubes, cuboids (rectangular prisms)
  - triangular prisms, spheres and cylinders
- cartons and containers of different shapes and sizes
- other construction materials like Lego
- balls of different sizes and other spherical objects that roll
- coloured shape blocks or paper cut-out shapes that include triangles, rectangles, squares and circles
- geoboards
- examples of a circle, triangle, square and rectangle with labels for the wall
- number cards, shapes, posters and pictures of different 3-D objects and shapes
- play dough, plasticine or other modelling materials
- crayons, paper, string, a feely bag to hide different shapes in
- multilink cubes or similar materials that join together on each side
- full length mirror, small mirrors
- metre stick or straight rod, the length of an average learner's height
- newsprint, crayons, paint, paintbrushes
- collection of objects and pictures that are both symmetrical and asymmetrical
- beads, threading string
- worksheets with half drawn objects that are symmetrical for learners to complete
- an arrow chart with a moving arrow
- bean bags
- any objects around the classroom or school environment that learners can easily move into different positions
- songs and rhymes you can use to teach learners the vocabulary of position.

### **Additional resources needed for Grade 2:**

- pictures with different views
- worksheets with block models
- grid paper

### **Additional resources needed for Grade 3:**

- photographs, symmetrical artefacts
- samples of different kinds of maps
- grid picture game boards and cards

The learner will be able to use appropriate measuring units, instruments and formulae in a variety of contexts.

## Skills and knowledge

### The learner:

- Describes the time of day using vocabulary such as 'early', 'late', 'morning', 'afternoon' and 'night'.
- Compares events in terms of the length of time they take (longer, shorter, faster, slower).
- Sequences events using language such as 'yesterday', 'today' and 'tomorrow'.
- Places birthdays on a calendar.

The vocabulary that learners need to understand and use for these skills is listed at the end of the suggested activities. You will find it helpful to make flash cards with key vocabulary words to support the teaching and learning process. A list of the resources you will need for the activities is also provided. (See [Resources](#))

## Suggested activities

### 1. Introducing time

#### Night and day

- Prepare pictures relating to daytime and night time and ask learners to put pictures under the sun or moon on a poster. Ask learners to explain the clues that helped them to decide in which column to place each picture.
- Ask learners to think about things they do in the daytime and things they do in the night time, and to draw pictures of their activities. They can add words to their drawings if appropriate, and then add pictures to the chart.
- Use words such as *morning*, *afternoon* and *evening* in a variety of contexts.

The cycle of day and night is the most dramatic of all the natural cycles that define time. To develop a sense of the cyclic nature of time, start with day and night. Ask the children how day and night are different. Make a large display of the activities that happen at night and the activities they do in the daytime.

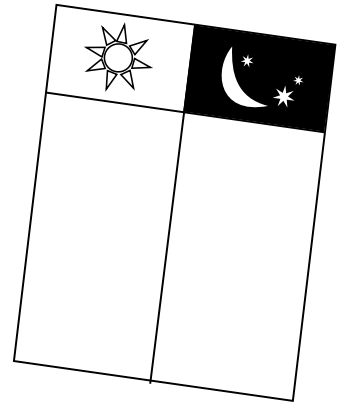

#### Making time pictures

Have the learners make pictures of activities they do at different times of the day - getting up, going to school, playtime, lunch, painting, outdoor games, going home, supper, getting ready for bed. Let learners say if they occur in the *morning* or *afternoon*, in the *early morning* or *evening*, etc.

#### Timelines

To develop a sense of the linear nature of time, have the learners make timelines of events in their lives and guide them to sequence events that happened during a given interval, e.g.

- things you did between 12 and 1 o'clock
- things you did this morning
- things you did yesterday



## The school day

Make a timeline or schedule of the regular events in the school day. For each event show the clock time in words and numerals, the event in words, and a picture or symbol representing the event.

## Watching the sun

At different times on one school day observe the motion of the sun across the sky with your class. *Be sure they understand that looking at the sun is very damaging to their eyes and they must never look directly at the sun.*

## Sun pictures

Have learners draw pictures of the sun rising, the sun high in the sky, and the sun setting. Place these pictures in the correct sequence on the timeline.

## Midday

Where is the sun at noon or midday? Go outside at noon and let the learners see that the sun is high in the sky at noon, although it's not exactly overhead.

In learning about time, as in learning anything, the new ideas must connect to the experience and knowledge the child already has. Sequencing activities should refer both to the learners' own specific experiences, and to events from stories you read or tell. The stronger the emotional relationship to the events, the greater the potential for learning. This is one of the reasons that reading and telling stories is a powerful way to introduce concepts.



## Using stories

In addition to using events from the child's life, use the events that occur in stories you read or tell them. Let the learners draw the events, sequence them and position them on the timeline. Help them develop an understanding of words that describe the relative position of events in time such as *after, first, last, next, soon, late, later, early* and *earlier*.

## 2. Timing activities

To help learners develop their intuition about how long a second, minute or hour is, use timers for a variety of activities. For example, say: "I would like you to draw for ten minutes. I'll set the timer. When you hear the bell you'll know that ten minutes is up."

### How long is a minute?

- "Put your heads down on the desk and close your eyes. From when I say start, raise your hand when you think one minute has passed. If it's too soon I'll let you know. Start now."
- "How many letters of the alphabet can you write in one minute? Begin when I say start, I'll tell you when to stop. Start now."
- "How many jumping jacks can you do in one minute? Work with a partner. One will jump and the other will count. I'll tell you when one minute is up."

Let the learners think about other things they can do in a minute.

### What time is it now?

From time to time, ask the learners what time they think it is and listen to their responses. Tell them the actual time to the nearest quarter hour. Repeat this on different days and observe how they develop a sense of time.



## Grade 1: Measurement

### Timing by counting

Let learners count together at a steady rate as a way to time activities. For example, learners could take turns walking, running, skipping, dancing, crawling, or hopping around the circle while the class times them by counting in unison.

### Timing activities

Ask learners to think of other ways to time activities to find out which takes longer. For example, eating an apple compared to eating a sandwich; buttoning a shirt compared to tying a shoe; walking to school or walking home.

- Ask learners to make lists of the tasks they must do each morning when they get up and get ready for school. What are the tasks they must do at night to get ready for bed? What takes a long time and what takes a short time?
- Prepare pictures of actions that take a longer time and others that take a shorter time.

Ask: "Which activity takes a longer time? A shorter time?" Have children explain their thinking. Then ask children to volunteer their ideas of other things they do each day, and whether they think it takes a long time or a short time.



## 3. Yesterday, today and tomorrow

Use the words *yesterday*, *today* and *tomorrow* in a variety of contexts:

### Time wheel

Use a wheel with the days of the week on it. Each day turn it so that the current day aligns with Today, the next day aligns with Tomorrow and the previous day aligns with yesterday. Ask challenging questions like: "If today is Sunday, what was yesterday? ... tomorrow? ... two days ago?"

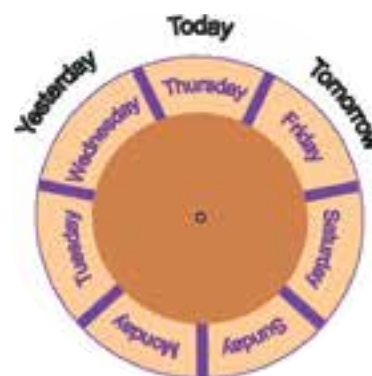

### Weather chart

Use the weather chart to discuss what the weather was like yesterday, what it is like today and what it might be like tomorrow.

### Time pictures

Have learners draw pictures of something they did yesterday, something they are doing today, and something they will do tomorrow.

### Daily chores

Discuss the learners' responsibilities for chores for yesterday, today and tomorrow.

### Using stories

Prepare pictures of events from a story you've read or told, or from the learners' experience, and show them, in no particular order, to the class. Ask: "Which picture comes first? next? last?" As learners talk about the pictures, encourage them to use sequencing vocabulary of time, such as *first*, *next*, *last*, *yesterday*, *today*, and *tomorrow*.

### Activity wheel

Discuss what happens in school on each day of the week. Make an activity wheel with the classroom activities that happen each week on the same day. Show the activity in words as well as in a picture or symbol. Have learners draw, talk, and write about what they do on Saturday and Sunday.



## Growing beans

Plant beans and let learners observe the different stages of their growth. Later, give them pictures of the different stages and let the learners put them in the correct sequence.



## 4. Birthdays on the calendar

Use the classroom calendar to point to all the important events of life at school as well as learners' birthdays and other events that are important to them.

It is helpful to display not only the current month but also the next month and the previous one so that learners can see the record of what had happened and what is in the future.

- "How old are you now? How old will you be on your birthday?"
- "How many months until your birthday? How many weeks?"
- "What day of the week is your birthday this year?"
- "Which month has the most birthdays? Which has the least? Make a birthday graph."
- "Which learner was born first? Who was born last?"

Learners can make birthday cards for friends or family members.

## 5. Integration with other learning contexts

If you are satisfied that your learners have understood the previous concepts, then you may want to use the following investigations as well. They give learners the opportunity to observe and start to understand the sun, shadows and the movement of the sun and the earth.

### Sunrise and sunset

- Where does the sun rise? Where does it set? When you are outside with the children point out to them where the sun came up that morning on the eastern horizon and where it will set on the western horizon. Similarly, orient them inside the classroom so they know where the sun rises and sets. Have them ask for adult help at home to know where the sun rises at their house, and where it sets.
- The rising point will move north and south of due east with the changing seasons. You can observe the shift with the learners.
- If you can see the sun when you are assembled outside in the morning, describe or ask the learners to describe its location. "It's just to the left of the tree", "today it's over the green roof", and note how it moves during the year.

### Observe shadows

#### Shadow play

Guide learners to investigate the sun's motion by observing shadows cast by the sun. Ask: "What makes a shadow? Do different kinds of objects make different kinds of shadows?"

This activity is done outside and requires a clear sunny day. Let learners begin by exploring their own shadows.

- Have the learners work in pairs. Give each pair two different colours of chalk – say white and blue. They take turns to stand still like statues while their partner traces around their shadow with the first piece of chalk. They use the second piece of chalk to outline the position of their partner's feet. The "statues" can stand in any position they like, so long as they hold still while their partner does the tracing. They must take careful note of their standing positions so that they remember them when



## Grade 1: Measurement

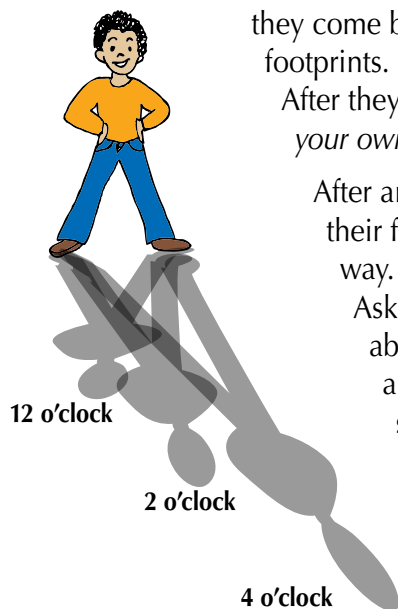

they come back. They must write their names in their footprints.

After they have drawn the shadows ask: *“Could you draw your own shadow? What happens when you try?”*

After an hour, have them go back to their positions, place their feet in their footprint outlines and stand in the same way. They take note of how their shadows have changed.

Ask them about both the position of the shadow and about its length. How are the shadows different? Why are the shadows different? Ask the learners if they are sure they are standing in the same place and in the same way. Have them predict where the shadow will be in one or two hours. Each partner should again draw the outline of the other’s shadow.

Measure at intervals of about 1 hour until the end of the school day.

### Shadow puppets

Have learners explore shadows inside the classroom. If you have access to a projector or another strong source of light, use shadow puppets to illustrate some of the stories you read to the learners. Let the learners invent stories using their own ideas for shadow puppets.

The next activities also take place outside on a sunny day.

### Shadow games

- Play games with their shadows, such as shadow tag, where the learner who is ‘it’ must try to step on the shadow of another learner who then becomes ‘it’.

### Shadow experiments

- Have learners explore the shadows their hands can make. What happens when they bring their hands closer to the ground, or move them farther away? Can they make the shadow fall where they want it to?
- Have them put something on the ground – a pebble or a chalk mark, for example, and try to make a circle around it with the shadows of their fingers.
- Have the learners work in pairs or small groups to explore the shadows made by different curved objects. Try a hula-hoop, a ball, a plate, an umbrella, an oval platter or a piece of card cut in an oval shape. Encourage them to investigate how the shadow changes when they change the angle of the object. Can they make an oval shadow from a round object? Can they make a round shadow from the oval platter? Which different shapes can they make from the umbrella?



### More about the sun

The sun’s path through the sky

In Grade 1 the learners’ observations of the motion of the sun should be qualitative only, and focused on the daily motion of the sun and not on its annual motion. It is enough to observe that the sun’s path through the sky during the day changes during the year. The common misconception that the sun always rises exactly due east and sets exactly due west makes it difficult for learners to understand the reasons for seasons when they encounter them in later grades.

## The sun and our shadows

Keeping in mind the position of the sun in relation the classroom, do this demonstration. Use a small figure to represent a learner. You are going to demonstrate how the figure's shadow changes as the sun moves across the sky. Show the path of the sun – trace an arc with your finger – it rises near the east, climbs high in the sky, though not quite directly overhead, then sets in the west. Darken the room as much as possible. Use a flashlight or a lamp to represent the sun, and let the light source move along the sun's daily path. Have the learners observe and describe how the shadow of the "learner figure" changes. Be sure that they notice that the shadow always points away from the light, and that it is long when the sun is low in the sky and short when the sun is high in the sky. Ask them to compare the shadow of the figure with their own shadows that they drew outside.

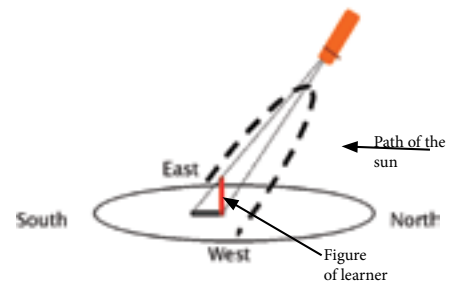

## Where is the sun at night?

Where does the sun go at night and how does it get back to the right place to rise again in the morning?

Inside the classroom, ask the learners for their ideas about where the sun goes at night and how it gets back to the other side of the sky in time for sunrise. Accept all answers.

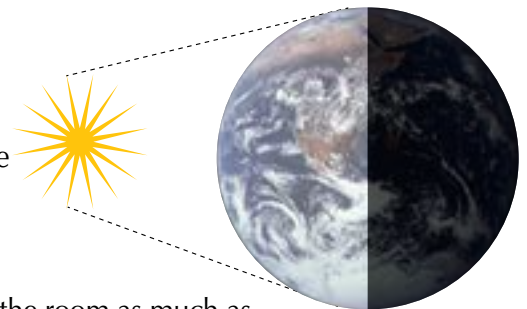

Have all the learners form a circle, each facing outward. Darken the room as much as possible, except for a lamp without a shade that you place at the centre of the circle. Ask the learners if they can see the lamp. Why not? Have learners put their left hands over their hearts. Their fingers point in the direction they are going to turn. Model for them how to spin without turning their heads right or left, but rather turning their whole bodies slowly in the direction of their fingers. When can they see the sun? When can they not see it?

Tell the learners the earth also spins. We have daytime when our part of the earth faces towards the sun and we have night time when it is facing away from the sun. Demonstrate the rotation of the earth with a round object such as a globe of the earth or an orange.

## The sun and the earth

Tell the learners about astronauts who travel in space ships and go far enough away from the earth so that they can get a good look at it. Show them a picture of the earth taken from space. Ask what they see. What part of the picture is cloud? What is ocean? What is land? Where is Africa? Where is South Africa? Tell the learners the earth is shaped like a ball, and a globe is a model of the earth. Show them where they are on the globe and attach a small figure there with Prestik. If you do not have a globe you can use any cylindrical object such as an orange. Use a lamp to represent the sun. Darken the classroom. Let the earth spin slowly on its axis and have the learners say when the figure is in sunlight and when the figure is in darkness. When is it day where we live, and when is it night?



## Expanded opportunities

- Help learners observe when the figure is just passing out of shadow and into daylight. That is dawn. Dusk is when it is passing from light into dark, noon is when the figure is lined up with the sun, and midnight is when the figure is opposite the sun.
- Put a second figure at a different part of the world. Ask if anyone in the class has relatives living far away. Observe how the times for day and night differ for the two figures.
- Ask the learners where the stars go in the daytime. Accept all answers. Put pictures of

## Grade 1: Measurement

stars on the walls all around the classroom. Explain that there are stars in the sky in the daytime, too. We just can't see them because the sun is too bright. Demonstrate this with a penlight. On a sunny day, darken the room and shine the penlight onto a paper. Then take it outside in the sun and show them that they can't see it in the bright sunlight. Repeat the activity with the learners in a circle and the sun in the centre of the circle. This time help them see why the stars rise and set as the world rotates.

### Skills and knowledge

#### The learner:

- Estimates, measures, compares and orders three-dimensional objects using non-standard measures:
  - mass (e.g. bricks, sand bags);
  - capacity (e.g. spoons, cups);
  - length (e.g. hand spans, footsteps).

### Suggested activities

#### 1) Mass

Learners develop an intuition about mass by experimenting with pushing, pulling, and lifting.

As learners go about their daily tasks, and in free and directed play, encourage them to hold, push, pull and lift objects, especially those that are clearly of different mass. Give them balls of different mass and let learners compare how far they are able to throw them. If there is something heavy that needs to be moved, ask for learners' ideas on how to divide a heavy load into several lighter loads, or how to use a trolley or wheelbarrow or other aid to lighten the load.



#### Free play with an equal arm balance

Have learners work in small groups. Without directing the learners too much, let them experiment with an equal arm balance and a variety of objects and record their findings.

Ask:

- "If you look at these two objects, which one do you think is heavier?"
- "Show me how you can find out which object is heavier?"

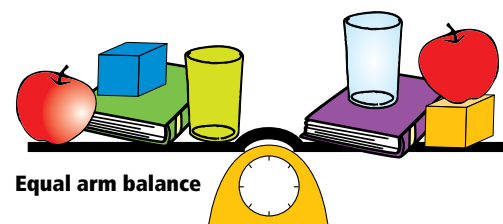
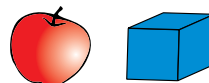

#### Big boxes

Show learners two large boxes of the same size and shape, one empty and the other filled with heavy objects. Ask the learners how the boxes are the same and how they are different. If the learners want to lift the boxes, explain that they are too heavy to lift and ask them to think of other ways to find out about their mass. Encourage them to push or pull the boxes and to compare the effort it takes to push the full box compared to the empty box.



#### Whose bag has more mass?

Give each pair of learners two non-transparent bags and ask them to put objects of different masses into them. Have them exchange the bags with another pair, and ask each pair to decide which bag is heavier.

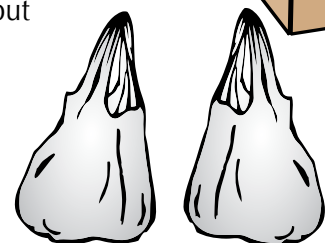



Ask:

- “Could you tell which bag was heavier by just looking at them?”
- “Could you tell which bag was heavier by just lifting them?”
- “What did you use to help you work out which bag is heavier?”

### What’s in the box?

Learners work in pairs. Give each pair a set of objects – for example a tennis ball, a rock and a ping pong ball – and a box with a lid. At first both learners see the set of objects. Then, without the other learner seeing, one learner chooses an object, puts it in the box, closes it and hides the remaining set of objects so the other learner can’t see which object is missing. The second learner must find a way to work out which object is in the box, without opening the lid. She must explain her method and her reasoning.



### Light as a feather

Choose pairs of objects of about the same size but of very different masses. Ask a learner to lift the two and to say which is lighter, which is heavier, and why they say so. Have each learner draw their pair of objects and attach them to a class chart with 2 columns respectively labelled **heavier** and **lighter**.

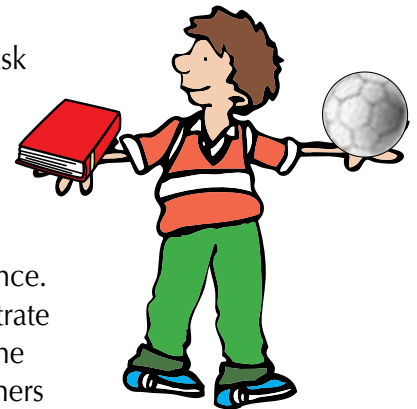

### A balanced child

Have a learner stand with his or her arms outstretched like an equal arm balance. Hold an object in each of *your* hands and ask learners to predict and demonstrate what will happen to their arms if the objects were placed in *their* hands. Put the objects in each of the learner’s hands to test his or her prediction. Let the learners record their findings by drawing and labelling a picture.



### Sorting

Give learners a set of objects. Select one object and have learners sort the others into those that are heavier and those that are lighter than the one chosen. Start with objects that are very different in mass. As learners develop their ability to determine mass, give them sets of objects with less obvious variations.

### Blindfold

Have learners work in pairs, taking turns to wear a blindfold. One learner places an object or container in each hand of the blindfolded student and asks which is heavier. They then check to see if the idea was right and record their results. They can check using a balance or ask the teacher to check the labels.

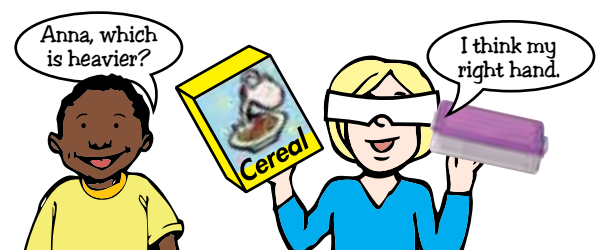

### What does heavy and light look like?

Have learners pick up two objects. They decide which is heavier. Then they predict which side of a balance scale will drop and which will rise. Have learners draw pictures of their results showing the objects on each side and the tilt of the balance arm.

### Is your bag heavier?

Learners work in groups. Each group has a collection of different objects. Choose a number and have all the groups put that number of objects in the bag with the goal of producing the heaviest bag. Choose a panel of judges to decide, by picking up, which bag is the heaviest. Congratulate the winning group. Choose another number and have them repeat the activity several times.



# Grade 1: Measurement

Ask:

- “How did you choose which objects to put into your bag?”
- “How can you change the mass of your bag?”
- “Does the **size** of the object you chose change the mass of the bag?”
- “How did you test to see whose bag was heavier?”

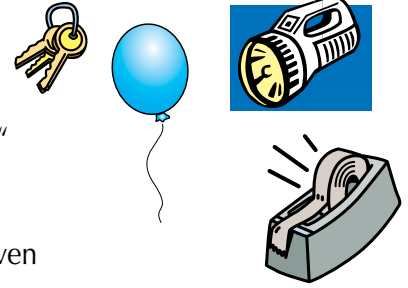

Repeat the activity with the goal of producing the lightest bag for a given number of objects.

## 2) Capacity

Learners develop an understanding of volume and capacity doing daily activities as well as through free and directed play. Experiences which help to develop their intuition about capacity include:

- packing away materials
- filling a variety of containers using handfuls, cups, sieves, spoons and scoops
- filling containers with materials such as sand, water, gravel or pasta
- filling containers to the brim
- filling one container and pouring the contents into another
- filling boxes with smaller objects such as cubes
- packing and unpacking toys.



### Sand moulds

Have the learners make sand moulds using containers like buckets or yoghurt cups as moulds. Learners explore making sand castles using damp, wet or dry sand. Then they compare their sand castles to the original mould and to the sand castles made from the same mould by other learners. They must say which mould they think their peers used to make each castle.

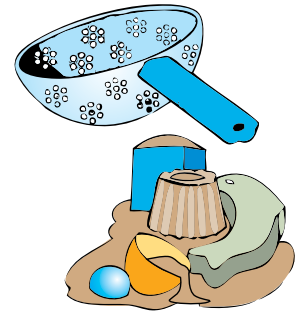

### Full or empty

Give each group of learners a set of labels for ‘full’, ‘empty’ and ‘half-full’ and a variety of containers and substances (water, sand, beans, marbles, small blocks). Learners fill some containers, partially fill others, and leave some empty, and then put the appropriate label on each container. Learners record the activity using drawings and words.



### Pouring and packing

Give each group of learners a collection of different sized containers. Have one learner select one of the containers and fill it with material such as pasta or blocks. Ask the other learners to find containers that hold more or less than the chosen container. Each learner checks his or her prediction by pouring the pasta or the blocks from the first container into the selected container. Learners record their results.



Use questions like:

- “How can you tell if the second container holds more or less than the first container?”
- “How did you predict whether the second container would hold more or less than the first container?”
- “Would you get different results if you used a different ‘filler’?”



### Holds more, holds less

Give learners a collection of containers. Choose one and ask the learner to find out which containers have a larger or smaller capacity than the one you chose. Learners can predict and check by filling containers with sand or beans from one container to another. They should record their results by drawing a picture of the target container in the centre of the page, and making pictures of the containers that hold less on one side and those that hold more on the other.



### Who has the greater capacity?

Give each pair of learners a bucket of beans and two identical clear containers. They will investigate who can hold the most beans in their two hands (cupped together). Each learner places the beans into one of the clear containers and compares the containers to determine who can hold the most beans in their hands.

### Towers

Have learners work in groups to build a tower. Give two groups an identical set of materials to build with and ask them to build a tower using all the blocks. The materials can be all of one type or can include a variety of shapes and sizes, but each group must get the same set of materials. Have the two groups compare their two towers.

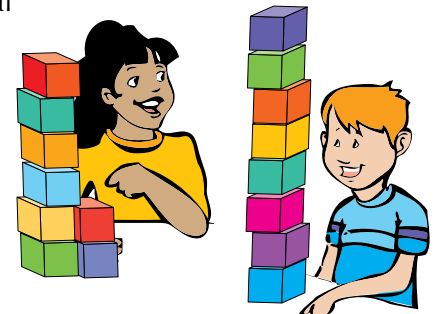

Ask:

- "Who made the tallest tower?"
- "Who made the widest tower?"
- "Which tower takes up the most space?"
- "How can we check this?"
- "Is there an easier way to check?"
- "Why are the towers different?"

Allow students plenty of time to look for strategies to decide which tower takes up more space, or whether the towers take up the same space.

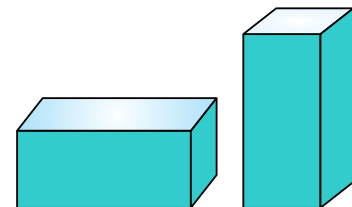

### Containers with the same capacity

Have the learners select two containers that they think have the same capacity from a large collection of containers. They must then test their prediction by filling one container with water, sand, grain, beads, marbles or other appropriate material, and transferring the contents to the other container. Have the learners give a demonstration to other learners, explaining how they compared their two containers using appropriate vocabulary like: more and less, full and empty.



Ask:

- "How do you know when a container is full?"
- "What does it mean when all of the water from one container does not fit into another container?"
- "Are marbles good for measuring? Why or why not?"

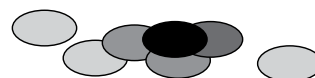

### Packing

Give the learners a certain quantity of small objects like cubes, blocks, marbles or buttons and ask them to predict whether or not that quantity will fill a box. Then have the learners select a quantity they think will fill the box, and test their prediction by checking.

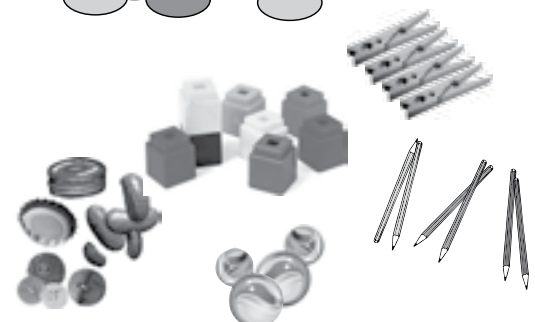



## Grade 1: Measurement

Ask:

- “How will you know how many blocks you used?”
- “Can you draw how you work this out?”

### Stacking

Ask the learners to build a wall from available materials such as blocks, cans, or boxes. Ask them to explain why they chose the materials they chose. Then have them build a different wall.

Ask:

- “How did you create your wall?”
- “Are there other ways of stacking the objects you used?”
- “Which object was the easiest to stack?”
- “Which wall is the biggest? How do you know?”

## 3) Length

### Comparing objects

Each group needs a collection of common classroom objects to compare, such as crayons, space cases, straws, chalk, scissors, etc. Select an object that the learners will use to compare the other objects to - a glue stick, for example. The learners will fold a sheet of paper in half to make two sections, then open the paper and trace the glue stick in the middle of the paper. Learners must then find six objects that are shorter than the glue stick and six objects that are longer.



### Ordering objects

Ask the learners to put the six objects in their shorter group in order from the shortest to the longest. Observe to see how they go about the task. Ask guiding questions like, “How do you think you can find out which one is longer?” and “How do you know that the chalk is shorter than the scissors?”



Then let the learners put the six objects in their longer group in order from shortest to longest.

### Does it fit?

Choose an object like a shoe box and have each learner look for three things that are shorter than the length of the shoebox. In order to develop their estimation skills, they should try to select their objects without directly comparing them to the shoebox. However, after they have chosen something, do allow them to check, if they need to, to see if it fits in the box.

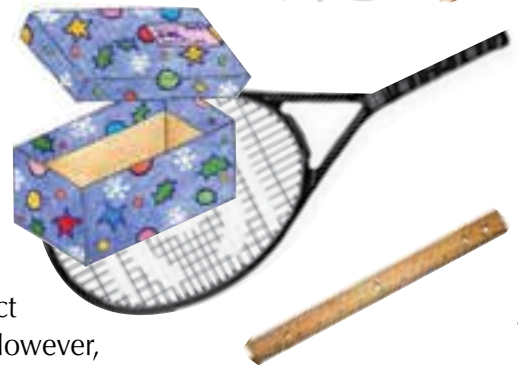

### Ordering and graphing

Give the learners lengths of cash register tape or thin strips of paper to use to represent the length of each object. Show them how to lay an object on the strip and mark the two ends of the object. Then they carefully fold the strip along the mark and cut a piece of the strip the same length as their object. They should indicate which object the piece corresponds to by labelling it with a picture, word, or symbol. They should then measure their other two objects with the strip, cut pieces to length, and label them. Finally, they will put their three rectangles, representing the lengths of their three objects, in order, from shortest to longest and glue them to a background to make a graph.

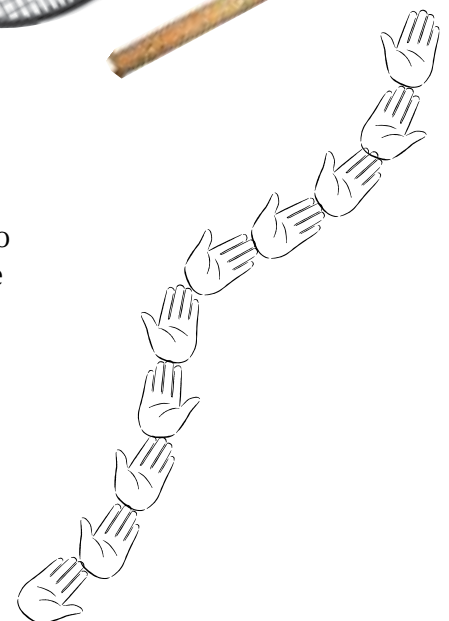

### A handprint tape measure

Have learners make a handprint tape measure. On construction paper, let them trace and cut out multiple copies of their hand, placed flat with fingers together. Then they carefully place the hands in a row, without gaps or overlapping. Many learners will need help to do this. Then they attach their handprints to a length of sellotape to make a tape measure. Allow them to explore the classroom and the yard with their tape measure. Ask, "What can you find that is one hand print big? Two? How many hands tall are you?" Then have each learner measure his or her desk. Ask, "How many hands long is it? Did everyone get the same answer? If not, why not?"

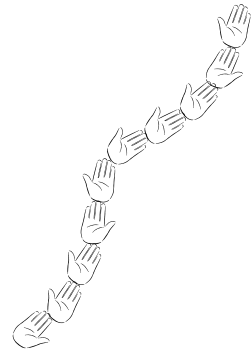

### Are you a square?

Have children work in pairs to find each other's height with a length of string. Then have them cut another string (use a different colour string) equal to the length from fingertips to fingertips (their reach). Which is greater, their height or their reach, or are they about the same? Make a chart showing who is a tall rectangle (height greater than reach), who is a wide rectangle (their reach is greater than their height), and who is a square (height and reach are about the same).

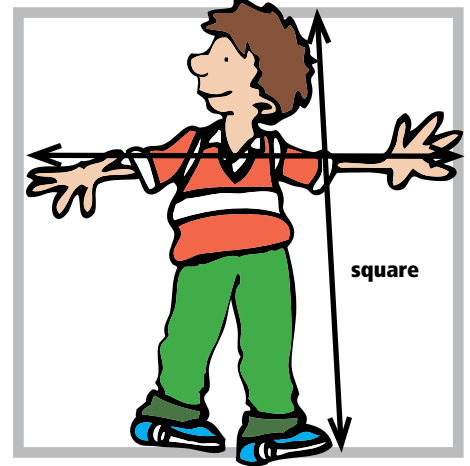

### Measuring teams

Invite learners to search the playground together as 'measuring teams', using their pieces of string to measure the size of other objects. Can they find something on the playground that is bigger than they are? Smaller? The same size? Then, ask partners to show the group the different-sized objects they found.

### Are you six feet tall?

Have each child trace a foot on a sheet of construction paper and cut out the tracing. Then suggest that children use the cut-outs to measure objects in the room. Which objects are a foot long? Can they build something that is about a foot high? How many feet tall are they? Have them make more cut-outs of their own foot until they have enough to equal the length of string that measures their height (their height will be equal to about six of their feet). How many feet tall are they? Check whether they are measuring by putting their feet cut-outs together, without gaps or overlap. If not, guide them and give them a variety of measurement opportunities until you see that they understand 'no gaps and no overlap' when they measure in a new situation.



## Vocabulary

If you do not teach in English, use equivalents in your language of instruction.

### Time:

early	late	day	night	morning	afternoon
evening	before	after	beginning	end	clock
watch	face	hand	later	earlier	sunrise
sunset	shadow	o'clock	clockwise	anti-clockwise	half past
quarter past	quarter to	minutes past	minutes to	fast	slow
today	tomorrow	yesterday	names of days of the week and months of the year.		

### Mass:

heavy	light	heavier	lighter	heaviest	lightest
heavier than	lighter than	more/less	same as	has greater mass	has less mass.

a light object has less mass  
a heavy object has more mass

### Capacity:

full	empty	holds more than	holds less than	half full
the same as	least	most	cups	buckets
jugs glasses	estimate	container.		

### Length:

longer	shorter	taller	higher	as long as	as short as
estimate	high	low	shallow	hand span	foot
pace	centimeter	metre	millimetre.		

## Resources

clock faces without numbers  
spinners  
special dice

grid paper  
scissors  
sellotape  
aluminum foil  
water  
sand  
containers of various sizes  
beans to plant  
plastic or cardboard shapes  
tangrams  
string  
rulers  
blocks or other material to stack and build with  
boxes  
bags  
feathers  
rocks

a scale or balance  
objects for casting shadows  
torch  
table  
lamp  
pictures relating to time of day  
pictures relating to holidays of different cultures  
picture of the earth from space  
constellation maps and star finders  
information on Islamic, Hindu, Jewish, Chinese  
calendars  
holiday dates, timetables, newspapers,  
information on the times of historical events,  
times from local or school sports.



The learner will be able to collect, summarise, display and critically analyse data in order to draw conclusions and make predictions, and to interpret and determine chance variation.

## Skills and knowledge

### The learner:

- Collects everyday objects (alone and/or as a member of a group or team) in the classroom and school environment according to given criteria or categories.
- Sorts physical objects according to one attribute chosen for a reason (e.g. 'Sort crayons into colours').
- Gives reasons for collections being grouped in particular ways.
- Draws a picture as a record of collected objects.
- Constructs pictographs where stickers or stamps represent individual elements in a collection of objects.
- Describes own collections of objects, explains how they were sorted, and answers questions about them.

## The data handling process

Data handling involves a progression from the concrete, to the pictorial, to the abstract.

We know that learners need a lot of experience counting real things, and then connecting the 5 real things to 5 pictures or 5 dots, before the abstract representations of '5' or 'five' have meaning for them. In the same way, they also need a lot of work with concrete graphs before moving on to more abstract representations. There are big conceptual leaps from concrete, to pictorial, to abstract.

Learners should engage in collecting, sorting, representing and analysing data every day. They need experience with objects like geometric shapes which have well defined attributes such as shape, size and colour. They also need experience collecting things that interest them and choosing their own criteria for sorting, which may be more subjective. In all these cases their process of exploration is what is important.

Grade 1 learners also need a lot of experience with concrete objects, sorting the concrete objects into groups and displaying them.

Later they will arrange the concrete objects in horizontal and vertical rows, to make a concrete graph. When they do this they are developing the foundation for understanding pictographs, and the bar graphs they will encounter later.

Graphs made from pictures (pictographs) are the next stage. Continue to work with sorting concrete objects, even after you introduce pictographs, to help learners connect the real objects with graphs. Learners need a lot of guided experience to help them connect concrete objects, and later, the ticks and symbols they use to represent these objects, to the blocks in their graphs.

The vocabulary that learners need to understand and use for these skills is listed at the end of the suggested activities. You will find it helpful to make flash cards with key vocabulary words to support the teaching and learning process. A list of the resources you will need for the activities is also provided.

## Suggested activities

### Collecting and sorting activities

#### Examples of objects that learners can collect

counters	litter	boxes
shapes	stones	sticks
building blocks	beads	buttons
pencils	marbles	bottle tops
lunch boxes	fruit, vegetables	sweet papers
pictures of animals	money (coins + notes)	shells
shoes	balls	stamps
leaves (e.g. autumn leaves)	toys	books
	blocks	



#### Suggestions for criteria to sort objects

**Size:** big/small, tall/short, long/short, fat/thin, thick/thin

**Mass/weight/capacity:** heavy/light, more/less

**Age:** old/new, old/young

**Colour:** primary/secondary colours

**Shape:** triangle, circle, rectangle, cone, can roll or cannot roll

**Texture:** rough/smooth, soft/hard

**Number:** range 0 – 34, multiples of 10 from 0 - 100

**Speed:** objects that move and can't move, fast/slow (animals, transport)

**Material:** What it is made of, e.g. plastic, leather, glass, paper, wood, steel

#### Free sorting

If you do not have sets of shapes such as these, use coloured paper or cardboard to make shape sets for your learners.

First allow learners time for free exploration of the shapes. Then ask them to sort the shapes, in any way they like. Some children may have sorted them spontaneously during free exploration.

This activity should be repeated a number of times with the same materials. Sometimes have the learners work in groups, other times let them work independently. When you observe that a learner or group has sorted according to size, help

the learner fix the shapes onto card or paper so you can show the whole class what the arrangement looks like. Ask the learner to explain to the class the “rules” s/he used to sort the shapes.

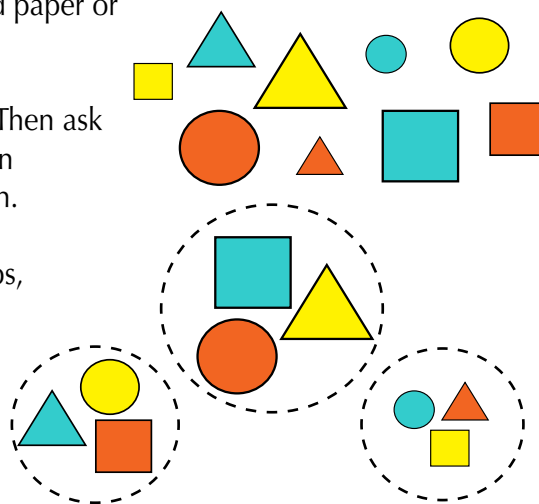

Do the same when a learner or group sorts according to colour, and according to shape.

Also give learners many opportunities to freely sort collections of different kinds of objects.



## Grade 1: Data handling

### Sorting according to a rule you give

Once the learners have enough experience sorting according to their own criteria, give them a sorting rule. Ask them, for example, to put all the squares together, all the triangles together, and all the circles together.

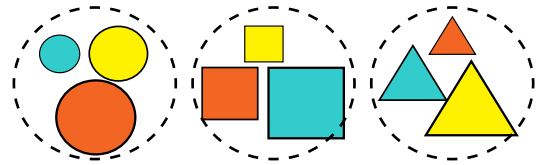

Sorting by shape

When they have had enough time to complete the task, give them string to put around each group.

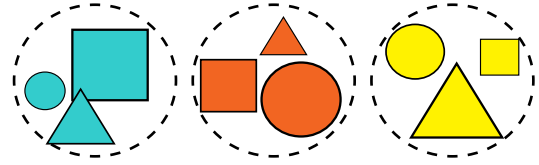

Sorting by colour

Repeat these steps with many other collections of objects. Sort things on their desks, sort things on the floor, sort things outside, sort things on the board. Letting learners choose their own rule for sorting and asking them to sort according to a rule you choose are separate processes. Both are equally important. Alternate between giving them a rule and letting them choose the rule.

### Guessing the rule

Let the learners choose secret sorting criteria, and have the whole class (including the teacher) try to guess their rule. Let learners work in pairs, one sorting according to his/her own secret rule, the partner guessing how he/she sorted. Then they change roles.

### Making graphs

#### Concrete graphs

After learners have sorted many different kinds of objects, using both their own criteria and criteria you give them, you can introduce concrete graphs.

Choose a set of objects with clear attributes, like the set of shapes, for example. Let the learners work in pairs. Ask them to sort their objects according to a criterion you give - for example, ask them to sort by colour. Let them circle each group with string.

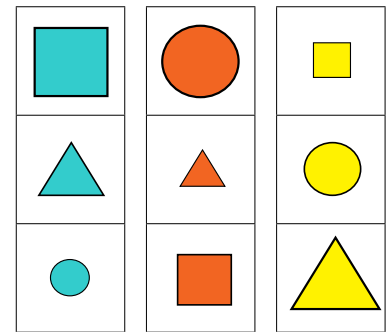

When all the learners have their sets sorted, ask them to make a concrete graph by putting each group in a line.

Provide additional concrete graphing experiences with other collections of objects, sometimes sorting according to criteria you choose, and at other times having the learners choose the criteria.

#### Pictographs

After your learners have worked with concrete graphs in many different contexts, you can ask them to make a record of a concrete graph by drawing a picture of each element in a box.

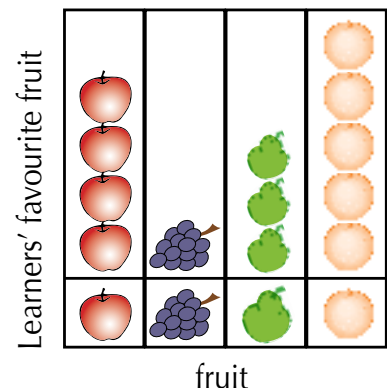

We use blocks of equal size in a pictograph to see the quantity represented by the height of the vertical column, or the length of the horizontal row. Using blocks is a way of giving the same weight to each item.



## Data handling in mathematics activities

Activities with the calendar, time and weather offer many opportunities to practice reading and creating graphs and tables.

### Patterns of time

Tables are often useful for working out repeating and growing patterns and for making predictions according to the patterns. Learners encounter very important repeating patterns in the cycles of the clock, the day, the week, the month and the year. In data handling, we need to identify and use patterns to help us sort and organise data. Here are some activities that use patterns in time:

#### Time of day

Make cards for activities that happen at different times of the day – going to bed, eating meals, brushing teeth, going to school, studying in class, playing, classroom chores, going home, etc. Let the learners sequence the activity cards according to time.

#### Days of the week

How is Monday different from Thursday? Help learners to understand the cycle of the week by mentioning any activities that occur regularly at school on particular days of the week. Have the learners work in groups and make posters showing their activities on each day of the week. Display them in a circle, to reflect the fact that the week is a cycle.

#### The month and the moon

During the first term, point out the moon each day if it is visible during school hours. Point out the moon in the daytime sky and help learners notice how it changes. During the second term, make cards with the phases of the moon on them. Have learners observe the moon every day. When it is visible during school hours, look at it in the sky together and decide what symbol to put on the calendar. In the third term, remind them to look at the moon in the evening. During class the next day decide together which symbol to put on the calendar.



Holidays



Winter



Summer

#### Seasons and cycles of the year

At the beginning of the year talk about the weather each day. Connect the vocabulary with their sense experience by describing the weather as hot or cold, warm or cool, as they experience it.

After you have introduced the idea of the seasons, bring to class a lot of different objects that the children might use in different seasons – a swim suit, a warm coat, seasonal sports items, holiday decorations, etc. Have a labelled box for each season. Let the learners come up one by one and choose an item to put in the box for the appropriate season. Make sets of cards with pictures of items or activities relating to each season. Let learners work in groups or pairs to sort the cards according to season. They can make posters for each season by attaching the cards to paper with prestik.

# Grade 1: Data handling

## Weather chart for April

Monday	Tuesday	Wednesday	Thursday	Friday	Saturday	Sunday
		1 ☁	2 ☁	3 ☁	4 ☀	5 ☀
6 ☀	7 ☀	8 ☀	9 ☀	10 ⚡	11 ☁	12 ☁
13 ☁	14 ☁	15 ☁	16 ☁	17 ☁	18 ☁	19 ☁
20 ☁	21 ☁	22 ☁	23 ☁	24 ☀	25 ☀	26 ☀
27 ☀	28 ☁	29 ☁	30 ☁			

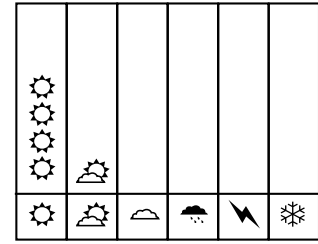

Weather graph for 1 week (Pictograph)

Later in the year make cards with symbols to represent the weather. Each day discuss the weather. Have a different pair of learners decide which weather symbols to put on the calendar. At the end of a month, ask the learners to find out how many days had each type of weather.

## Birthdays

Ask the learners to think about how it would be possible to find out who has a birthday in the same month as they do. Let them discuss their ideas in their groups. Then ask them to stand with the others who share their birthday month. Don't tell them how to do this, let them figure it out. There will be a few minutes of chaos, but they can do it. You can do this outside if you prefer.

Once all the learners are in groups with the others whose birthday month they share, lead a discussion about what they notice, e.g. "August has the most birthdays." "There is only one birthday in February."

Then have the learners make a concrete birthday graph by forming rows or columns by month.

Have each learner make a card with his or her name. You may want to let them decorate the cards. Then make a birthday pictograph by having each child place his or her name card in the row or column for the month they were born.

Young learners need to move, and they enjoy making concrete graphs with their bodies.

Data handling in the early years requires some patience on the part of the teacher. Give the learners time to figure things out for themselves. A little apparent chaos is healthy. Don't jump in too soon with instructions. As soon as the teacher says what the answer is or how to find it the learners stop trying to figure it out for themselves.

Birthdays in our class

							☺				
							☺				
	☺			☺			☺				
	☺			☺			☺				
☺	☺		☺	☺			☺				
☺	☺		☺	☺			☺				
☺	☺	☺	☺	☺			☺	☺			
☺	☺	☺	☺	☺			☺	☺	☺		
Jan	Feb	March	April	May	June	July	Aug	Sept	Oct	Nov	Dec

## Lost teeth

Each time a learner loses a tooth, cut out a picture of a tooth, have the learner write his or her name on the cut-out, and add it to the lost teeth pictograph.

	☺										
☺	☺	☺									
☺	☺	☺	☺								
Jan	Feb	Mar	Apr	May	June	July	Aug	Sept	Oct	Nov	Dec

### Our bodies

Have learners work in pairs to make life-sized posters of their bodies. One child lies down on a piece of craft paper and the other traces around his body. They can measure their height and other dimensions in non-standard units like new crayons. When you are teaching about the body they can use their life-size profile to display the functions of the parts of the body. Let the children see themselves in a mirror. Have them draw a picture of their face. Be sure they draw the ears, eyes, nose and mouth. They can attach the face drawing to their life size posters.

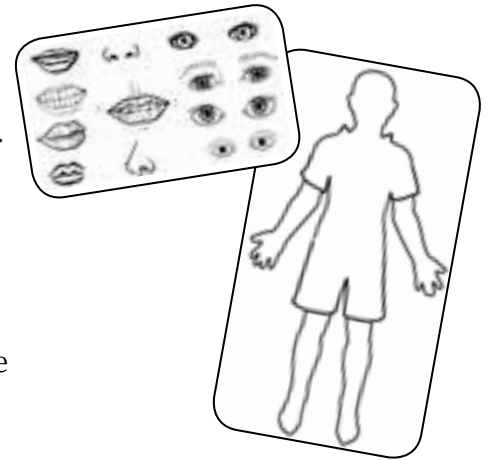

Have the learners work in groups to find out how many noses there are in their group. (There could be some question about whether a person has one or two – since each person has 2 nostrils. Clarify that each person has only one nose.) Then ask them to fill in a chart with the number of noses, eyes, mouths, ears and hands in the group. Observe the different methods they use for finding the number.

When you teach about the five senses, have each learner think about something he likes to hear, see, smell, taste or touch. Make a class poster for each sense with the list of learners' favourite things.

X		X
X		X
X		X
X	X	X
X	X	X
X	X	X

eyes      mouth      ears

Key: X = 1 body part

In order to support the learners in their own mathematical thinking, and to understand what they are thinking, it is important to listen carefully, without assumptions about what is 'obvious' or 'simple'. The simplest mathematical idea is wonderfully complex when viewed through the eyes of a child who is encountering it for the first time. Let the learners wrestle with their efforts to understand. Too often we cut short their thinking by coming in too soon with the correct adult answer.

### Combinations and chance

In the early years we do not talk about chance and probability in abstract terms, but learners should have many experiences with games involving dice, spinners, coin tosses and activities where they count the possible combinations. These experiences help to build the foundation for an understanding of probability when they encounter it in the later years.

### Money

Give learners sets of play money of different denominations. Where necessary, substitute notes and coins from you local currency. Ask them to find all the different ways they could make R2 if in each case they used only one kind of coin, e.g. 2 one rand coins; 4 fifty cent pieces. Throughout the year when you are doing activities with money, ask the learners to find all the different ways of making a particular amount. Support them by asking a variety of probing questions, like:

“Suppose you have three coins – one, two or three 5 cents, 10 cents, and 20 cents. Find all the amounts you could make using coins, e.g. you can make 5c, 10c, 15c, 20c, 25c, 30c or 35c with these coins.” When they have done a few problems with 3 coins, give them examples with 4 coins.



# Grade 1: Data handling

## Odd and even

Learners work in pairs.

You will need: Cards with dots like the faces of the dice, either prepared ahead or made by the learners.



1. One player chooses odd and the other chooses even.
2. They take turns throwing the die.
3. They put the card for the number thrown on the column graph. The player who chose "odd" can only put out a card when the die lands on an odd number pattern. The other player can only put out even dot patterns in the even column.
4. The player whose cards fill up the column first is the winner.
5. They switch roles and play another round.

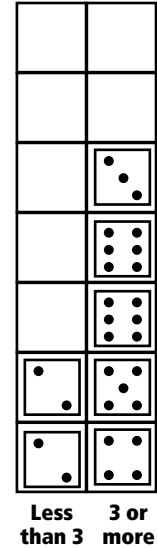
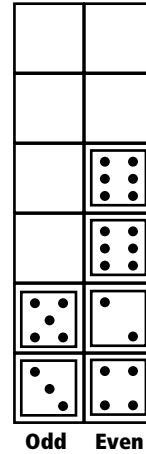

This game helps reinforce the learners' understanding of odd and even, as well as giving them practice with column graphs.

## More or less

On another day, have learners play a similar game, but instead of odd and even make columns for "Less than 3" and "3 or more". Again, the one who fills the column first wins.

# Summary of the types of graphs used in Grade 1

## 1. Sorting circles (Venn diagrams)

When children begin to sort objects, show them how they can indicate their groups clearly by creating a line around them with crayon or with string. Later they can learn how to draw pictures of the objects in groups, and circle the objects that belong together. Although the learners sort groups of objects with many attributes, in the early grades the learners sort on only one attribute at a time, and the sets do not overlap (intersect).

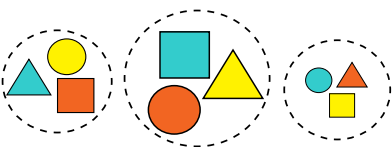

First we sorted the shapes by size. We put the big ones together in one group and the small ones in another. The middle sized shapes made a third group.

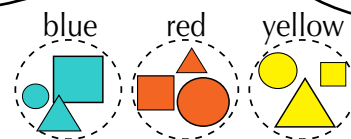

We put blue shapes in one group and red shapes in a group and yellow shapes in a group. We sorted the shapes by colour.



## 2. Concrete object graph

A concrete object graph involves categories and counts of the number of people or things in a category (frequency). Actual people or things are placed on the floor, desk or paper to display the categories and counts. The layout of the graph can be in any direction. The layout here is horizontal.

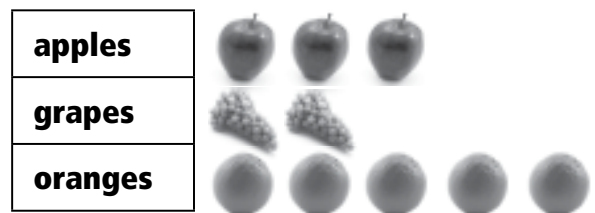

## 3. Pictograph or pictorial graph

A pictograph or pictorial graph involves categories and counts of the number of people or things in a category (frequency). Drawings or other pictures are used to display the counts in each category. The layout of the graph can be horizontal or vertical. The layout here is horizontal.

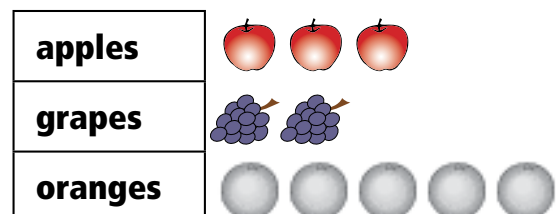

## Vocabulary

If you do not teach in English, use equivalents in your language of instruction.

### Grade 1:

- collect, sort, classify, arrange, compare, order
- graph, pictograph

### Grade 2 - add the following to the Grade 1 vocabulary:

- tally, list, diagram, Carroll diagram, symbol, table

### Grade 3 - add the following to the Grade 1 and 2 vocabulary:

- column, row, bar graph, scale.

## Resources

### Grade 1:

- things that learners can collect and sort
- daily programme, birthday graph
- measuring tools such as arms, feet, hand spans, bottles, buckets, spoons, balances (scales)
- sorting circles (Venn diagrams), concrete graph, pictograph, number line.

### Additional resources for Grade 2 and 3:

- clocks, calendars with important dates, weather chart
- extra measuring tools for distance around a shape and for area such as string and tiles
- tally sheets, Carroll diagram, lists, tables, bar graph.

# Grade 2: Numbers, operations and relationships

The learner will be able to recognise, describe and represent numbers and their relationships, and to count, estimate, calculate and check with competence and confidence in solving problems.

## Skills and knowledge

### The learner:

- Counts to at least 100 everyday objects reliably.
- Counts forwards and backwards in:
  - a) ones from any number between 0 and 200;
  - b) tens from any multiple of 10 between 0 and 200.
- Knows and reads number symbols from 1 to at least 200 and writes numbers from 1 to at least 100.
- Orders, describes and compares the following numbers:
  - a) whole numbers to at least 2-digit numbers.
- Recognises the place value of digits in whole numbers to at least 2-digit numbers.
- Uses the following techniques:
  - a) building up and breaking down numbers;
  - c) using concrete apparatus;
  - d) number lines.

The vocabulary that learners need to understand and use for these skills is listed at the end of the suggested activities. You will find it helpful to make flash cards with key vocabulary words to support the teaching and learning process. A list of the resources you will need for the activities is also provided.

## Suggested activities

In order to help learners develop a good understanding of our counting system, **integrate** counting activities with sequencing (ordering), comparing, naming and describing, grouping, number patterning and place value work. Remember to introduce activities that progress from the concrete, to the pictorial, to the abstract.

### Counting concrete objects: building number sense

Give learners many opportunities to build knowledge of the 'how muchness' (numerosity) of each number, by counting different objects in and around their classroom. Depending on their previous experiences with concrete counting, different learners will be able to count correctly to different amounts. So it is best to allow them to count as many objects as they can, rather than deciding beforehand on a fixed amount for the whole group each day. Start with amounts that learners understand and gradually challenge them with bigger amounts up to at least 100.

Ask guiding questions to help you assess whether all your learners have developed the following important concepts and skills:

#### 1. Estimate and attach the correct number names to groups of objects

Check that your learners can link the number words with the objects as they count. We call this establishing **one-to-one correspondence** between



## Grade 2: Numbers, operations and relationships

the objects and their number names. They must understand that, to count correctly, they cannot simply 'sing' the number names in sequence as they point randomly to objects. They must know that the answer to the question, "How many are there?" is the last number name they say as they count and say one number name in sequence for *each* object in the group *once* and *once only*.

Check that learners have developed a sense of the size of numbers up to 34 by letting them estimate the number of actual objects in a group of objects or in drawings of groups of objects. Let them then check their estimates by counting. Ask them to try to find quick and easy ways to count each group of objects.

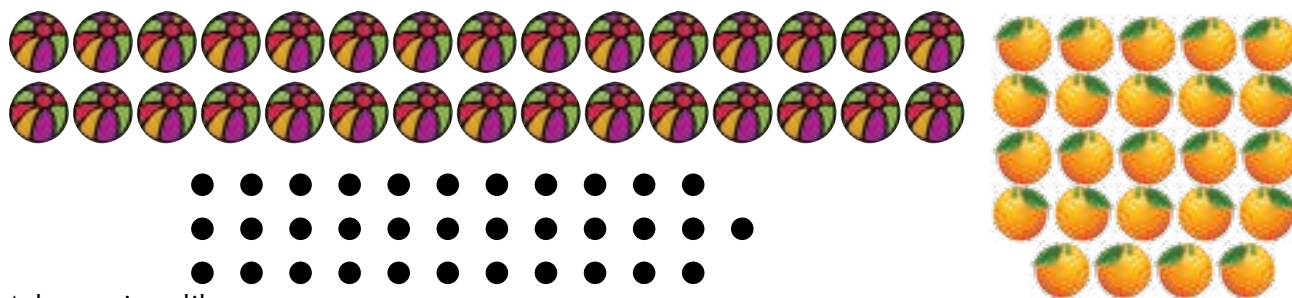

Ask questions like:

"What quick way did you find to count this group of objects?"

"Did you estimate more than there are? How many more? Did you over-estimate? By how many?"

"Did you estimate less than there are? How many less? Did you under-estimate. By how many?"

If you find that some of your learners cannot yet use one-to-one correspondence to count accurately for the numbers in the Grade 1 range, let them work through the various counting, sequencing and number naming activities listed for Grade 1.

To help learners practise and extend their skills, let them work more abstractly to count objects in drawings that have been grouped in ways that will encourage counting in different multiples.

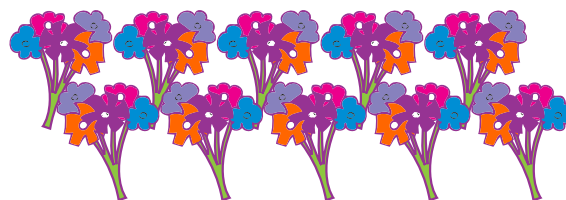

How many mouths do these children have altogether? How many eyes? ...ears?... fingers? ... toes? ... fingers plus toes? I want to buy five sweets for each of these children. How many sweets must I buy altogether?

Five more children join the group. How many more sweets must I buy? How many is that altogether?



Check that your learners understand that even if we rearrange the objects in the group so that they look different, the total remains the same. We call this **conserving number**. Let learners compare groups that are arranged in different ways. Ask them to tell you what is the same about the groups and what is different.

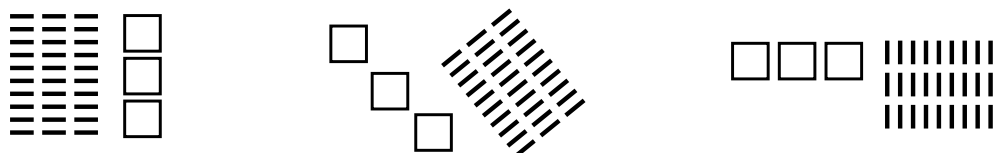



## Grade 2: Numbers, operations and relationships

### 2. Organising numbers

Learners need to learn to organise objects for quick, accurate counting and checking. As learners count bigger and bigger groups of objects, it becomes increasingly important that you encourage them to find their own quick ways to *organise* their objects and that they can explain what they did. Adapt and extend the Grade 1 counting activities, games and resources to include the required Grade 2 number range in this type of activity. For example:

#### Estimate and count

One learner puts out a large handful of objects (e.g. beans, stones, counters) on the table. Each group member writes down his/her estimate of the number of objects. As quickly and accurately as possible, the group counts and checks the actual number of objects. The group winner is the learner who makes the closest estimate. Encourage groups to find ways to group their objects for quick, accurate counting and checking. Play the game with bigger and bigger amounts up to 100.

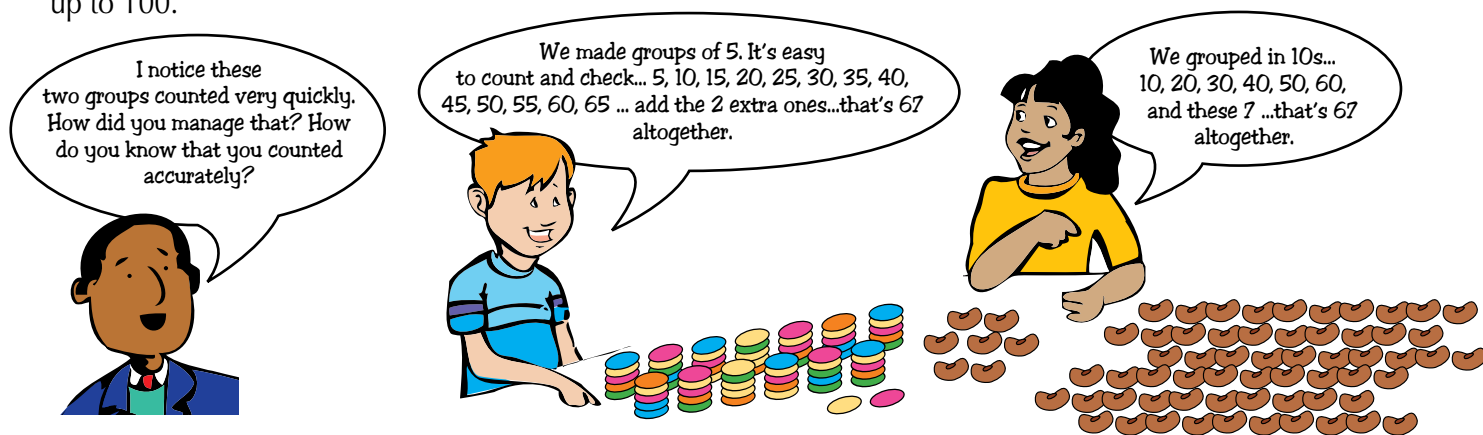

### 3. Comparing groups

Learners need to understand how to compare groups of objects and develop the appropriate vocabulary of comparison. Check that your learners have developed and can use words to describe comparisons in many different concrete situations e.g. more, less, fewer, as much as, a little, a lot, same, different, equal, about, nearly – or equivalents in home languages. For example, learners:

- Compare different aspects of themselves, e.g. "Who is the tallest? Who weighs more? Who is oldest?"
- Trace outlines of each other's bodies as they lie on large pieces of paper, cut the outlines out and order them from biggest to smallest;
- Compare objects, e.g. "Which container holds the most? Which weighs more?"
- Compare groups, e.g. ask one learner to find enough friends to make a group of five, another learner to form a group of three, another to form a group of four. Let the groups stand in rows. Learners must compare the rows and then order them in ascending (smallest to biggest) and descending (biggest to smallest) order. Ask questions like: "What is different about the row with three and the row of four? Which row has one less than the row with five? And two less?"

Vary the game by asking learners: "Form a group of one. Now form a group that has one more. How many in the new group?... one more... etc." or "Form a group of five... now form another group that has one (or two) less" etc.

## Grade 2: Numbers, operations and relationships

Later you can extend the game by letting the learners use counters, e.g. "Put out three counters. Now put out one more. How many are there now? Put down five counters. Take away one. How many are there now?"

- As learners start to work with bigger numbers in the Grade 2 range, let them work concretely to build ordered groups of objects for these numbers. This will help them to see how the numbers continue to grow by one each time in our counting sequence. They can use their number cards to label their number sequences.

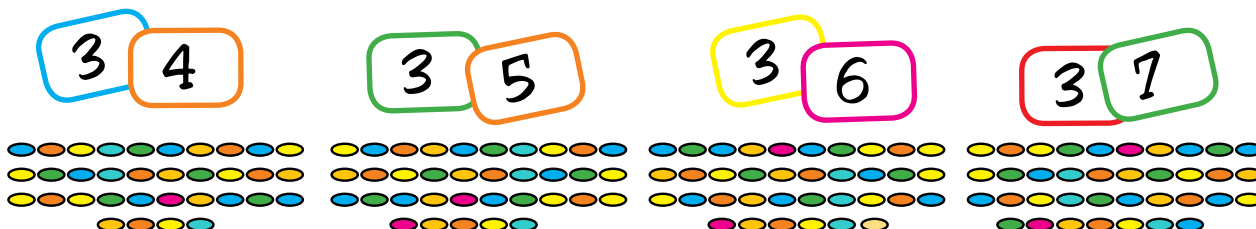

- As learners work on different activities, check that they develop the vocabulary of **ordinal numbers** by asking questions like: "How many counters must you put under your *first* number card?... under the *second* number card? ... under the *third* number card?"

Help learners extend their knowledge of ordinal numbers to include numbers in the Grade 2 number range through tasks like. "Look at the calendar. We are going on an outing on the fortieth day of the year. On what date will our outing be?"

See Resources, p360 - 362, for examples you can copy for your learners.

### 4. Patterns in our number system

Learners need to understand the patterns in the way we sequence and name numbers. Number boards and number charts are useful aids to help learners build links between numerosity and the sequencing patterns in our number system. If your learners have not previously worked with number boards, use and extend some of the counting forwards and backwards activities suggested for Grade 1. For example:

- On number boards, let learners put counters out one by one starting from one, as they count forwards, and taking counters off one by one as they count backwards. As your learners uncover the counting patterns and develop confidence, let them work with bigger and bigger numbers. This will help them develop a sense of the actual size of the numbers up to 100 and also help them see that there is a difference of one between the adjacent (next to each other) numbers in the counting sequence (one more going forwards and one less going backwards).
- Later change the activity in different ways. For example:

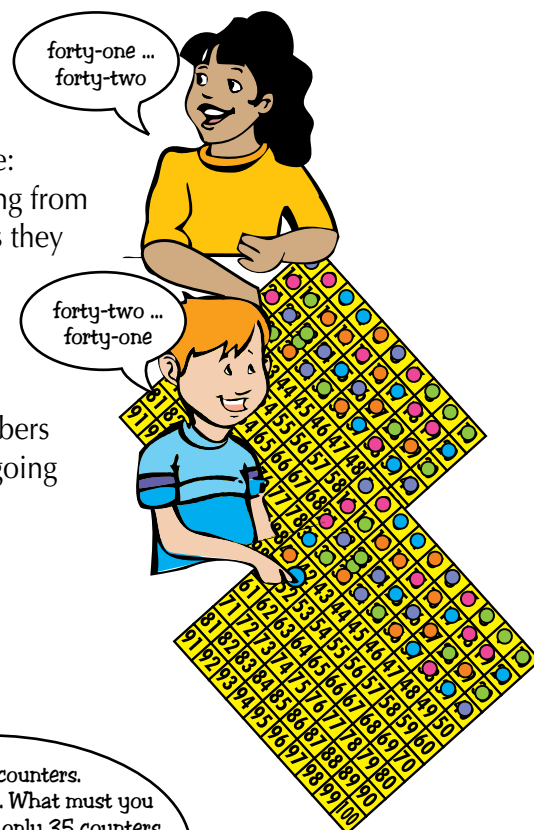

Put 34 counters on your board. How many more counters do you think you must put out to get to 40? Check your estimate by putting out and counting counters till you get to 40.

Put out 40 counters. Estimate and check. What must you do so that you have only 35 counters on your board? Which numbers come between 35 and 40? Which number comes before 34?... after 40?

## Grade 2: Numbers, operations and relationships

- Gradually introduce activities where learners must work more abstractly to *imagine* what will happen. For example:

Put a counter on 95 on your board. You are going to move five forward (or back) on your board. Where will you land? ... Check that you are correct - jump your counter five forward (or back) on your board.



Put your counter on 85. You are going to move 3 back (or forward). Where do you think you will land?... Check that you are right.

If you find that some of your learners have difficulty in finding and checking the positions for the numbers, let their peers demonstrate and explain their solution methods and ideas.

Learners can then work in pairs to challenge each other to predict where they will land as they move forwards or backwards by different amounts from various positions on their boards.



Find where 55 goes.

- Play similar games to those above but with blank boards. Learners must find ways to use their counting patterns and the relationships between the numbers to work out the positions of the numbers.

This is what I did. I wrote 1 in the starting corner. I counted to 5 on the top row... 1, 2, 3, 4, 5. Then I counted down the rows in 10s from there... 5, 15, 25, 35, 45, 55 must be here.

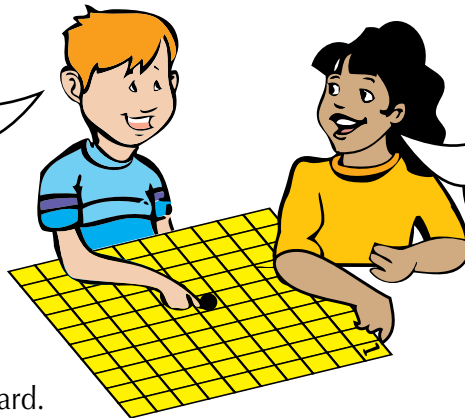

I did it another way. I counted to 10 on the top row. I reached the end of the row. Then I counted down in 10s...10, 20, 30, 40, 50. I counted onto the next row...51, 52, 53, 54, 55. I agree ... 55 must be there.

- Once learners can find the positions of numbers up to 100 on the blank 100-board, introduce a 101 to 200 board. Ask questions that help learners to see how they can generalise their knowledge of the counting patterns for numbers up to 200. It is particularly important to help learners understand that the number after 100 is one hundred and one (and not two hundred, as many learners, who have not had sufficient practical counting and patterning experience, believe). If you find that none of your learners can work this out, work slowly and systematically to help them use their patterning skills to recognise and read the symbols for all the numbers up to at least 200.
- Then introduce a blank board to represent the position of the numbers from 101 to 200. Ask questions and let learners investigate how they can use their counting patterns to find numbers from 101 to 201.



Did anybody do it a different way?

How many counters must we add to 100 to get to this number? ... Yes, Thandi you are correct, we add one more counter.

1	2	3	4	5	6	7	8	9	10
11	12	13	14	15	16	17	18	19	20
21	22	23	24	25	26	27	28	29	30
31	32	33	34	35	36	37	38	39	40
41	42	43	44	45	46	47	48	49	50
51	52	53	54	55	56	57	58	59	60
61	62	63	64	65	66	67	68	69	70
71	72	73	74	75	76	77	78	79	80
81	82	83	84	85	86	87	88	89	90
91	92	93	94	95	96	97	98	99	100
101	102	103	104	105	106	107	108	109	110
111	112	113	114	115	116	117	118	119	120
121	122	123	124	125	126	127	128	129	130
131	132	133	134	135	136	137	138	139	140
141	142	143	144	145	146	147	148	149	150
151	152	153	154	155	156	157	158	159	160
161	162	163	164	165	166	167	168	169	170
171	172	173	174	175	176	177	178	179	180
181	182	183	184	185	186	187	188	189	190
191	192	193	194	195	196	197	198	199	200



So what do you think we call this number? ... What do you think we call the next number? ... and the next?... Let's point to and count all the numbers from 101 to the end of the board.

- Check that your learners have uncovered and can use the patterns for counting in multiples of ten up to 100. Let them count the number of toes of 10 children and later let them fill in missing numbers in sequences of multiples of 10 going forwards and backwards:  
40; 50; \_\_\_; \_\_\_; \_\_\_; 90; 100.  
\_\_\_; 90; 80; \_\_\_; \_\_\_; 50; 40; \_\_\_; \_\_\_; 10; \_\_\_.

## Grade 2: Numbers, operations and relationships

- Let learners then use their number boards to discover that, when they count in tens beyond 100, the patterns for the numbers in the 10s place and in the 1s place repeat themselves.

I counted on in tens from 100. All my numbers still end in zero and they go up in tens, but with the hundred in front. So it's 110, 120, 130, 140, 150, 160, 170, 180, 190, 200. It's just like adding ten more each time!

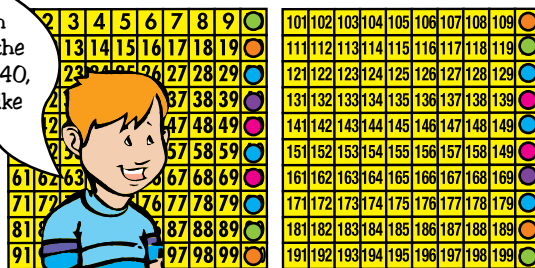

As learners work, ask questions like:

“How many numbers do you miss out each time you count on another ten?” “You count backwards in tens from 200. Do you think you will need to cover 135 with a counter? Why do you say so?” “How about 150? Why do you say so?... 115? Why?”

- You can also use number boards to help learners develop their understanding of **doubling and halving**. For example, let them put a counter on the board, say on the 2, then keep on doubling their number (2, 4, 8, 16, etc). Some learners may need to put out the actual number of counters on their desks and double them every time before they will be able to double on the number board alone.

Let learners reverse the pattern by halving repeatedly to develop the understanding that doubling and halving reverse each other.

- As doubling and halving are very useful calculation techniques, give learners lots of written and mental practise, using different formats, to help them build this skill. Start with small numbers and build up to bigger numbers in the Grade 2 range.



Double 2 ... double 7... double 32...  
Now let's halve ... halve 8... halve 18 ... halve 28 ...  
halve 50 ... halve 84

**Write the halves**

30

**Write the double**

24

**Write the halves**

120

Half is \_\_\_\_\_

Half again is \_\_\_\_\_

Half again is \_\_\_\_\_

- Let learners work on **number tracks and number lines** to extend and apply their understanding of counting patterns for numbers up to at least 200.

If some learners still struggle with number lines, start with number tracks, which are more concrete and understandable to young learners.

In the playground, let learners count as they jump forwards and backwards on a big track marked with familiar numbers. As an introduction, the numbers should start from zero. When learners understand the idea of a number track, help them to develop their skills for counting on from any number. Present tracks that start from other numbers within the Grade 2 range. At a later stage you can let your learners jump a counter forwards and backwards on a smaller track. Play games that challenge learners to predict and check where they will land



## Grade 2: Numbers, operations and relationships

with different sized jumps. For example:



You stand at 30 and jump 1 forward. On what number do you think you will land? ...check. You start at 45 and jump 7 backwards. On what number do you think you will land? ...check.

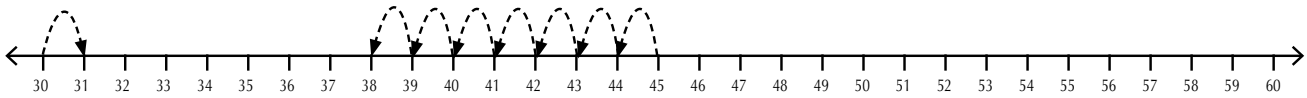

Once learners understand how to use the track to represent their actions, you can model how they can show their jumps in writing on **number lines**. Set challenges like: "You start at 78. You jump 2 forward, then another 10 forward and then 3 more forward. Where will you land?"

Learners can work out a solution on the number line.

To solve this problem: There are 93 girls in the class and 78 boys, how many more girls are there? Thabo draws a number line like this:

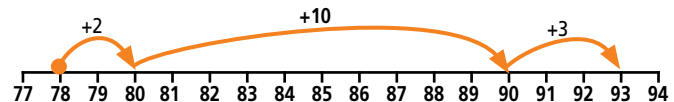

- Play **Work it Out** games. You can first link these to number lines, number boards or rulers. As learners develop confidence, let them work abstractly. Say: "Work out the secret number I am thinking about. My number is more than 50 but less than 52... My number is an even number between 47 and 50 ... My number is double of 23... My number is one bigger than half of 70."

Let learners make up their own secret numbers for their friends to work out.

Make cardboard cut-outs of number cards for each of your learners. (See Resources, p344).

### 5. Building two-digit and three-digit numbers

Learners need to be able to combine different values to read and write numbers up to at least 200. As learners work to understand the 'how muchness' and sequencing patterns of numbers up to at least 200, you can introduce number cards to help them understand how we combine different values to read and write numbers.

- If your learners have not used these cards previously, teach them how to arrange their cards in order, how to replace each card in its correct place after they have used it and how to hold the cards correctly when they combine them to make one number.
- Learners can then work in pairs. Challenge them to find and explain ways to build first 2-digit and then 3-digit numbers. Let them write the number in parts, and as a single number (e.g.  $20 + 6 = 26$ ). If you use a language like English, start with numbers in the 20s and 30s because the patterns are easier to understand than in the numbers from 11 to 19.

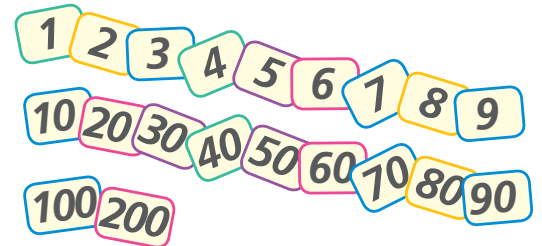

Hold up your 9 card. Now put it back in the correct place... Show me your 40 card. Now put it back in the correct place... How do you think you can make 49 with your cards?

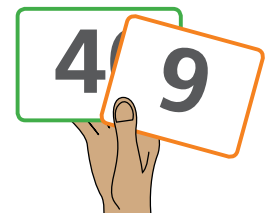

Think, which cards do you need to make 126? Find the cards. Put the cards together to make 126. Explain how you do this, then write your number in two ways.



We need 100 and 20 and 6 to make 126.

We put out the 100 then we put the 20 over the ten's place and the 6 in the one's place. We can write this:

$$100 + 20 + 6 = 126$$



Important note: During the early years it is not useful or necessary to teach place value by getting learners to write  $126 = 1H + 2T + 6U$ . This way of thinking is very abstract and does not come naturally to young learners. It often prevents them from understanding the patterns in our number system and how we use these patterns to break down and build up numbers in ways that help us find ways to calculate and to solve problems. Young learners understand and can use the concept of 'one hundred plus twenty plus six' ( $100 + 20 + 6$ ) more easily because this way of thinking matches the way they read numbers.

Through the activities you present and the guiding questions you ask, learners should develop these important ideas about how our number system works:

- Up to nine, we use a new digit and a new number name for each number (1, 2, 3, 4, 5, 6, 7, 8, 9).
- After nine we begin to group in tens, and in multiples of ten.
- We then place digits in different positions in numbers to show their values. When we write the number 59, for example, the place we write the 5 in shows that it stands for 50 and the place we write 9 in show that it stands for 9 'singles' or ones.
- We use a zero to show places in the number where there are no values. For example, in 70, the place of the zero shows that there are no ones in this number.

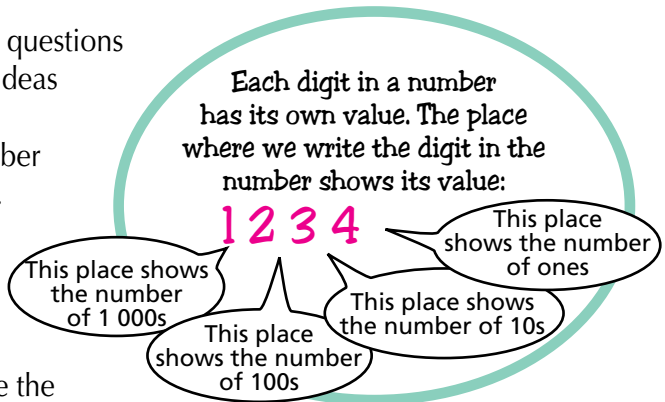

Learners need to break down and build up numbers into tens and units so that they can:

- understand how we use placing patterns to write multi-digit numbers;
- understand the 'short cuts' we use to write numbers like 78 (We put the 8 for the 'ones' in the place of the zero 'place holder' in the 70);
- understand that in a number like 49, the '4' shows a bigger value than the 9 because of its place in the number - the '4' stands for 40 and the '9' stands for 9;
- understand how they can combine and break up numbers to make it easier to calculate in different ways.



### 6. Activities to write, build and represent numbers

To reinforce learners' understanding of how we build up and break down numbers in multiples of 10 up to 200, play these two games:

#### Find the missing card game

- Draw a grid like this on the chalkboard (add extra rows at the bottom). Let pairs of learners copy the grid.
- They take turns to write a 2-digit number of their choice in the first column and to put out either a tens or a ones card in the middle column.
- Their partner must find the correct card and place it in the last column. Learners check each other's solutions.

My number	Card I have	Cards I need
28	20	8
34	4	

## Grade 2: Numbers, operations and relationships

### Estimate and count

- Give each group a tray that has between 100 and 200 matchsticks, toothpicks or straws, as well as some small and large elastic bands.
- Ask them to first estimate the number of objects in their pile, write their estimates down and then count to find the actual amount.
- At first let them group their objects in any way they like for quick counting. Later, use sticks and ask them to bundle them into 10s, using smaller elastic bands.
- Then ask them to count their bundles in 10s to see how many bundles of 10 they need to make a bundle of 100. Once they agree that ten bundles of 10 make 100, let them use larger elastic bands to hold 10 bundles of 10 together.
- They must then write down the number they get, which they can do in different ways. They can also use the number cards to show their numbers. Let groups take turns to share their solutions with the rest of the class.

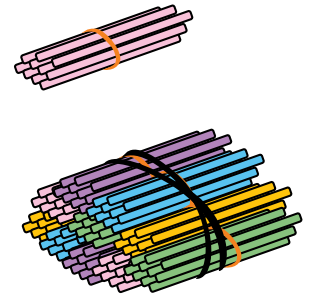

**1 bundle of 100 + 2 bundles of ten + 3 over**  
**100 + 20 + 3 makes 123**



Let learners work up to at least 200 with this type of activity. If you do not have sufficient sticks for all of them to work concretely, it is a good idea to let them imagine how the counting sequence will continue.

For example: "I see you have 123 sticks. I give you one more stick. How many will you have altogether? ... If I give you 4 more, how many will you have altogether? ... I give you one more bundle of ten, how many sticks will you have altogether? ... Your friend takes one of your sticks, how many will you have now? ... Your friend takes two bundles of ten, how many will you have altogether?" etc.

### Estimate and count with money

When learners are familiar with the values of our South African coins and notes, you can let them play estimating and counting games with play money. For example, let them take a handful of R1 coins. They estimate the total value and then check their estimates by counting. Encourage them to organise their R1 coins so that they can exchange them easily for coins of other values. This will make it easier for them to find totals.

In this document we use examples of South African money. Where necessary, substitute examples of your own country's currency.

See Resources, p356 - 357, for examples you can copy for your learners.

I put my R1 coins in piles of ten. I have altogether 10, 20, 30, 40, 50, 60, 61, 62, 63 rand.

I changed each of my 6 piles of one rand coins for six R10 notes. I still have R63.

I put my R1 coins in piles of 5. I have altogether 5, 10, 15, 20, 25, 30, 35, 40, 45, 46, 47, 48, 49 rand.

I changed my 9 piles of one rand coins for nine R5 coins.

Let me count how much money I have now... 5, 10, 15, 20, 25, 30, 35, 40, 45, 46, 47, 48, 49 rand. It's the same!



## Grade 2: Numbers, operations and relationships

### Spin the numbers

Use a set of spinners like these. You will find them in most maths kits or you can make them. Learners work in pairs or groups. They take turns to spin both spinners. They read the two numbers their spinners land on and use stick bundles and/or their number cards to build the number. They write the number – again, first in two parts and then as a single number ( $50 + 7 = 57$ ). Let them compare and order their numbers, from biggest to smallest or from smallest to biggest.

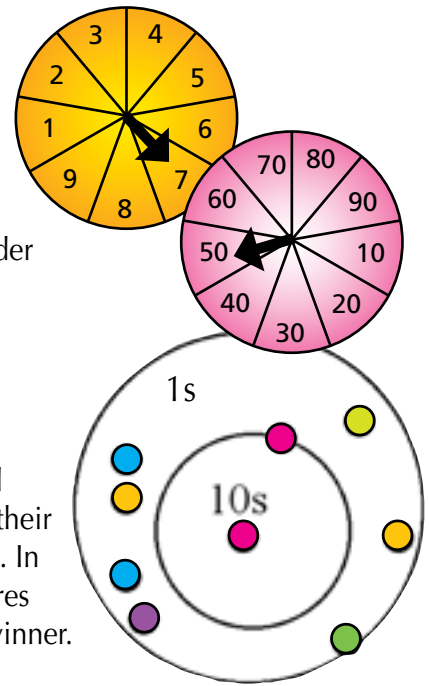

### Scatter boards

Draw, or let learners draw, a scatter board like this for each group of learners.

Each learner takes 10 counters. They take turns to close their eyes and scatter their counters onto the board. They work out and write down their scores. If a counter lands on a line, they use the value inside that line. In this example the score is 27. Group members can each add their scores from a series of throws and compare their results to find the overall winner.

By presenting learners with similar challenging tasks and questions in different contexts and with different aids, you help them build up, practise and reinforce their number knowledge. There is then no need for rote counting and rote repetition of number bonds.

See Resources, p349, for examples of spinners.

As learners gain confidence and experience with the links between the numerosity and sequencing patterns of increasingly big numbers, let them work more abstractly to show sequences and patterns in written form. For example:

### Using grid paper

Let learners use grid paper to show how they can break up 2-digit numbers into tens and ones. They use one colour to show the tens in the number and another colour to show the ones (units). They write number sentences alongside to show how they break down and build up the numbers. Start with numbers that have a single 10 (e.g. 12, 17). Gradually introduce bigger 2-digit numbers.



$$10 + 8 = 18$$



$$20 + 5 = 25$$

### Using shapes to represent numbers

Learners count drawings and exchange them for given values, for example:

In these drawings:  $\triangle = 10$     $\square = 1$

Count in 10s and ones. Write the correct numbers under each box.

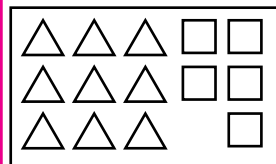

$$= 95$$

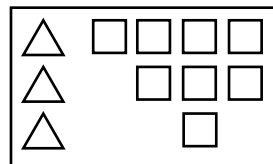

$$= \underline{\quad}$$

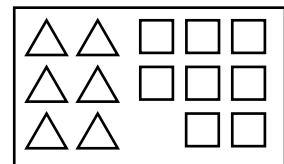

$$= \underline{\quad}$$

Write your three numbers from smallest to biggest.

Make your own boxes with different numbers of  $\triangle$  and  $\square$ .

Let your friends write the correct numbers under each box.

See Resources, p366 and p368, for example worksheets you can copy for your learners.

# Grade 2: Numbers, operations and relationships

## Missing numbers

- Learners fill in missing numbers on number boards or charts.
- Learners fill in missing numbers within the Grade 2 number range on a number line, or in pictures of a ruler or of a scale within the Grade 2 number range.

1	2	4	5	6	7	9	10
11	12	13	14	16	17	18	19
21	22	24	25	26	28	29	30
31	32	33	34	35	36	37	38
41	43	44	45	46	47	48	50
52	53	54	55	57	58	59	60
61	63	65	66	68	69		
71	72	73	75	76	77	78	80
82	83	84	85	87	88	89	90
91	92	94	95	96	97	99	100

101	102	103	105	106	107	108	110
111	113	114	115	116	118	119	120
121	122	123	124	125	126	127	128
131	132	133	135	136	138	139	140
142	143	144	145	147	148	150	
151	152	153	154	156	157	158	160
161	162	164	165	166	167	168	170
171	172	173	174	176	178	179	180
182	184	185	186	187	188	189	190
191	192	193	195	196	198	200	

- Learners complete a grid to show understanding of number sequences.

number	before	after	2 more than	1 less than	write number name	ordinal number
13	12	14	15	12	thirteen	thirteenth
21						twenty first
48						
53						

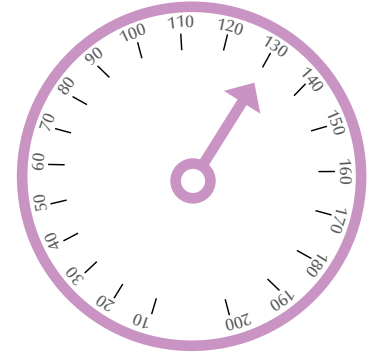

- Learners complete forward and backward number sequences, starting from any number within the Grade 2 range, e.g.

101; 102; \_\_\_; 104; 105; \_\_\_; \_\_\_; \_\_\_; 109; \_\_\_; \_\_\_

200; 199; \_\_\_; 197; 196; 195; \_\_\_; \_\_\_; \_\_\_; 191; \_\_\_; \_\_\_

- Learners can extend written sequences like this:

34  $\boxed{+1}$   $\rightarrow$  35  $\boxed{+1}$   $\rightarrow$  \_\_\_  $\boxed{+1}$   $\rightarrow$  37

130  $\boxed{+10}$   $\rightarrow$  140  $\boxed{+10}$   $\rightarrow$  \_\_\_  $\boxed{+10}$   $\rightarrow$  160

160  $\boxed{-10}$   $\rightarrow$  \_\_\_\_\_  $\boxed{-10}$   $\rightarrow$  \_\_\_\_\_  $\boxed{-10}$   $\rightarrow$  \_\_\_\_\_

## Ordering numbers

- Learners connect a series of numbered dots in the correct order to form a picture or a shape.
- Learners identify values of digits according to their positions in numbers.
- Learners write numbers in ascending order (from smallest to biggest) or in descending order (from biggest to smallest) according to their values.

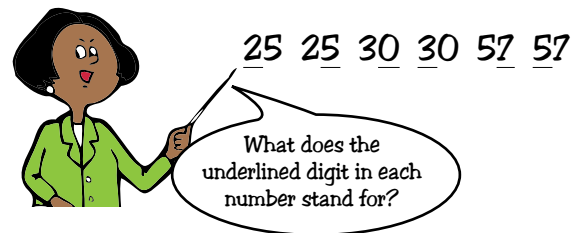

17 71 70 77 57 49

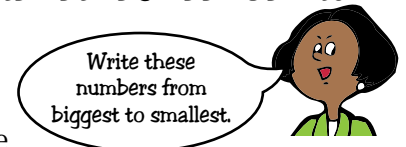

## Breaking down numbers

- Learners break numbers down in different ways to show understanding of place value: Let learners use a variety of representations to show the different ways they find to break down and build up numbers. Link these formats to the 'empty box' format for writing number sentences. Learners must explain their methods to each other:

<p>0 50  2</p> <p>50 + 2 + 0 = <input style="width: 40px;" type="text"/></p>	<p>25 25  2</p> <p>25 + 25 + 2 = <input style="width: 40px;" type="text"/></p>	<p>20 12  20</p> <p>20 + 20 + 12 = <input style="width: 40px;" type="text"/></p>
--	--	--

## Grade 2: Numbers, operations and relationships

Change and extend this format by writing some of the numbers outside or by using other outline shapes with more sides (to encourage learners to break numbers into more parts):

$90 + 3$   
 $20 + 20 + 20 + 20 + 10 + 3$   
 $50 + 20 + 20 + 3$   
 $10 + 10 + 10 + 10 + 10 + 10 + 10 + 10 + 10 + 3$

Find as many different ways as you can to break down these numbers.

### Ordering numbers in different areas of mathematics

- Integrate comparison work with **Data handling**. Let learners sort, describe, compare and order data collected for pictographs e.g. learners order themselves according to their ages, or they order the months of the year according to the number of children/boys/girls who have their birthdays in that month.
- Integrate with informal **measurement** activities, e.g. learners count the number of footsteps or strides they take to cover a given distance. They compare the number taken by bigger and smaller children and then order the numbers taken from most to least or from least to most. Challenge them to uncover the patterns in the numbers e.g. "The bigger the child's foot, the less footsteps she takes to cover the distance".
- Once learners have learned the value of different coins and notes, they describe, order and compare them. Extend the activity by giving them groups of coins and asking them to order the total amounts of money from biggest to smallest. Learners must explain their solutions.



## Skills and knowledge

### The learner:

- Counts forwards and backwards in:
  - a) fives from any multiple of 5 between 0 and 200;
  - b) twos from any multiple of 2 between 0 and 200.
- Orders, describes and compare whole numbers to at least 2-digit numbers.

## Suggested activities

### 1. Counting objects

Counting different parts of the body is one way to introduce 'skip' counting in multiples of 5 and of 2. For example:

- For **multiples of 2**, let learners count the number of eyes, ears, hands or feet in their group (and, as you go on, of bigger and bigger groups). At first, you can encourage learners to whisper the first number and say the second number out loud, so that they hear the pattern for counting in twos:  
1 2 3 4 5 6 7 8 ...
- Learners can practise counting in twos by organising handfuls of various objects (e.g. beans, pegs, counters) in groups of two and then counting them as quickly as possible. (Let learners, who need to do so, 'count all'. With more experience, through different activities, they will naturally begin to use quicker counting strategies.)
- Set challenges that encourage learners to think about the patterns for counting in multiples of two: "If you have 20 objects, how many groups of 2 do you think you will be able to put out? Do you think you will have any objects left over? ... If you have 21 objects, how many groups of 2 do you think you will be able to put out? Do you think you will have any objects left over? ... 22? ...23? ... 30? ... 31?" etc.

Introduce the terms **even numbers** (for those amounts where we can put out exact numbers of 2 objects with no objects left over) and **odd numbers** (for those amounts where we have one left over when we group in twos).

- For counting in **fives**, let learners count fingers and toes, and then put out objects in groups of five for quick counting. Help learners to focus on the patterns and relationships by asking questions like: "How many fingers do Mpho and Jane have altogether? ... Mpho, Jane and Fatima? ... How many fingers do 4 children have?", etc.
- Where necessary, let learners check by counting actual toes. Link this work to worksheets with body counting.

Learners	Fingers/toes
1	
2	
3	
	50
	70
	90
20	
25	
	200

### 2. Counting in multiples on number boards or charts

Working with number boards and number charts will help learners to:

- uncover and describe the counting patterns for counting in twos and fives;
- extend their understanding of the counting patterns to larger numbers;
- link the patterns for counting in twos and fives to the patterns for counting in tens.

# Grade 2: Numbers, operations and relationships

## Counting in twos

Learners count multiples of two and cover each number they say with a counter. As they begin to see the counting pattern, ask them to predict how the counting sequence will continue. Ask guiding questions to help learners make their own rules for counting in multiples of 2s.

Introduce blank boards to help learners extend the counting in twos to bigger numbers.

We counted in 2s up to 50. What do you think the next number in the 2s counting pattern will be? ... and the next ... and the next. How do you know?

I notice that the numbers always end in a 2 or a 4 or a 6 or an 8 or a zero.

Yes. Remember that we call these numbers even numbers.

You continue counting in twos. What do you think the next counting number in the twos pattern will be? ... Check on your number boards ... The next number? ... and the next number? What pattern can you use for counting on in twos?

I can go on with my twos pattern ... Let me think ... a hundred plus 2 is 102, plus 2 is 104, then 106, 108, 110... Then another 2. That's 112 ... on and on with my pattern.

1	3	5	7	9
11	13	15	17	19
21	23	25	27	29
31	33	35	37	39
41	43	45	47	49
51	53	55	57	59
61	63	65	67	69
71	73	75	77	79
81	83	85	87	89
91	93	95	97	99

Once learners can describe and extend their rules for counting in 2s, reinforce this work with challenges like these:

Sammy starts at zero and counts in twos up to 200.  
Circle all the numbers that Sammy says.

2   5   10   17   18   29   35   72   81   102   104   125   177   183   192   199

Explain to your friend why you circled these numbers.  
Make up some numbers of your own.  
Ask your friend to circle the numbers that Sammy says when he counts in twos.

You can repeat the counting in twos activity. This time let learners find and predict the counting pattern when they start from one and count on in twos. (1, 3, 5, 7, 9, ...)

Ask guiding questions to help them make their own rules for counting in 2s when they start from one. Point out that we call the numbers in this counting pattern 'odd numbers'.

2	4	6	8	10					
12	14	16	18	20					
22	24	26	28	30					
32	34	36	38	40					
42	44	46	48	50					
51	52	53	54	55	56	57	58	59	60
61	62	63	64	65	66	67	68	69	70
71	72	73	74	75	76	77	78	79	80
81	82	83	84	85	86	87	88	89	90
91	92	93	94	95	96	97	98	99	100

## Counting in fives



Let learners do similar number board activities to uncover, describe and extend the patterns for counting in 5s (and in 10s if they have not previously done so). Design different work cards or worksheets to help learners practise and become very familiar with all these patterns.

Important principles to remember are:

- Let learners who still need support, use the aids to build and check their ideas.
- Encourage confident learners to work mentally and use ever increasing numbers – they may even want to go beyond 200.

## Grade 2: Numbers, operations and relationships

- Integrate your counting in fives work with data work by introducing the idea of tallying. Show the learners how to record information in a way that makes it easy to count, by grouping their marks in fives.

Colour of learners' toothbrushes		
	////	4
	###	5
	### / /	12

### Comparing the counting patterns for twos, fives and tens

Let learners uncover and describe the similarities and differences between the patterns for counting in multiples of 2, multiples of 5 and multiples of 10.

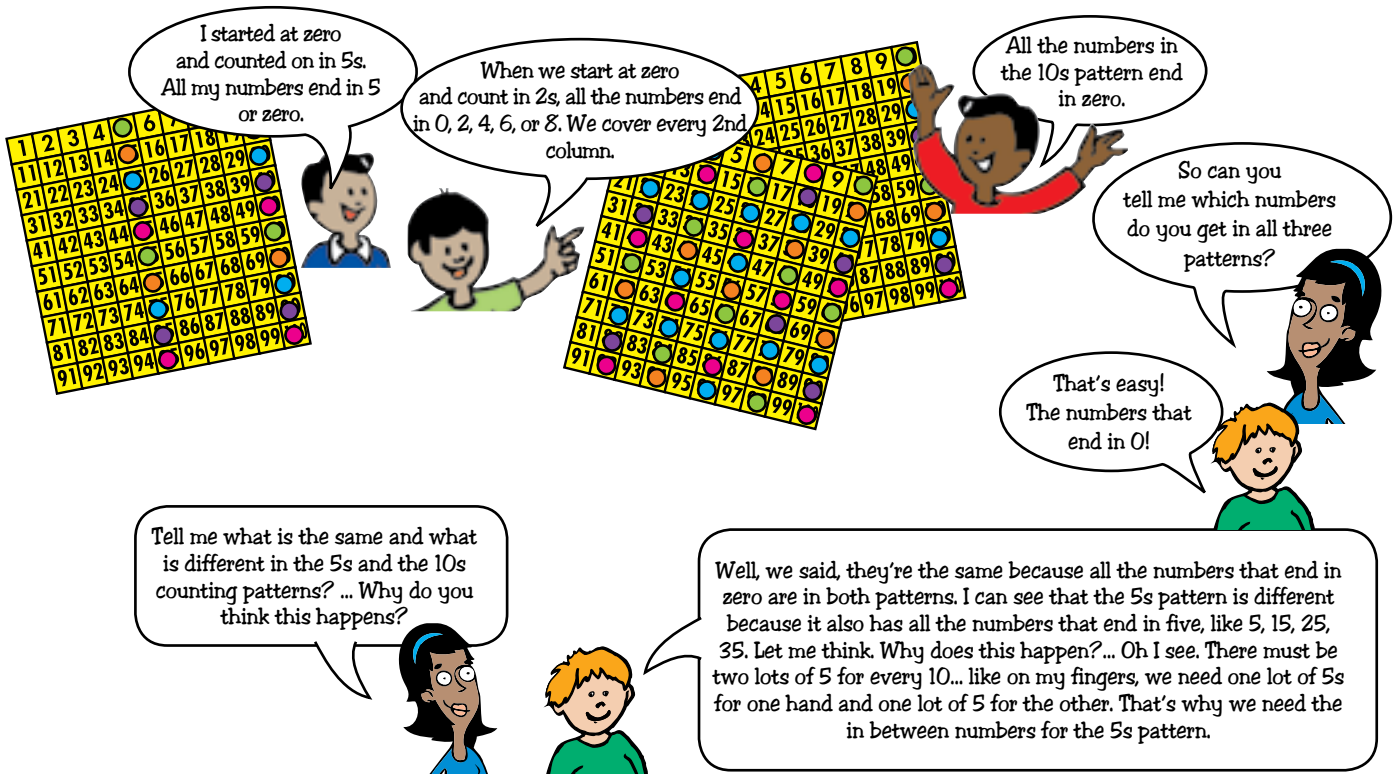

I started at zero and counted on in 5s. All my numbers end in 5 or zero.

When we start at zero and count in 2s, all the numbers end in 0, 2, 4, 6, or 8. We cover every 2nd column.

All the numbers in the 10s pattern end in zero.

So can you tell me which numbers do you get in all three patterns?

That's easy! The numbers that end in 0!

Tell me what is the same and what is different in the 5s and the 10s counting patterns? ... Why do you think this happens?

Well, we said, they're the same because all the numbers that end in zero are in both patterns. I can see that the 5s pattern is different because it also has all the numbers that end in five, like 5, 15, 25, 35. Let me think. Why does this happen? ... Oh I see. There must be two lots of 5 for every 10... like on my fingers, we need one lot of 5s for one hand and one lot of 5 for the other. That's why we need the in between numbers for the 5s pattern.



## Skills and knowledge

### The learner:

- Orders, describes and compares common fractions including halves and quarters.
- Solves and explains solutions to practical problems that involve equal sharing and grouping and that lead to solutions that include unitary fractions (e.g.  $\frac{1}{4}$ )
- Uses the following techniques:
  - a) building up and breaking down numbers;
  - b) doubling and halving;
  - c) using concrete apparatus;
  - d) number lines.
- Explains own solutions to problems.
- Checks the solutions given to problems by peers.

## Suggested activities

### 1. Sharing fairly

A good way to help learners develop an interest in and an understanding of fraction concepts is to expose them to **practical sharing situations** that arise in various contexts in their lives e.g. food, books, pencils, money, informal mass, length and capacity. The problems you present should include problems that challenge learners to find ways to deal with the 'left over bits' and to use their own informal language to explain their ideas.

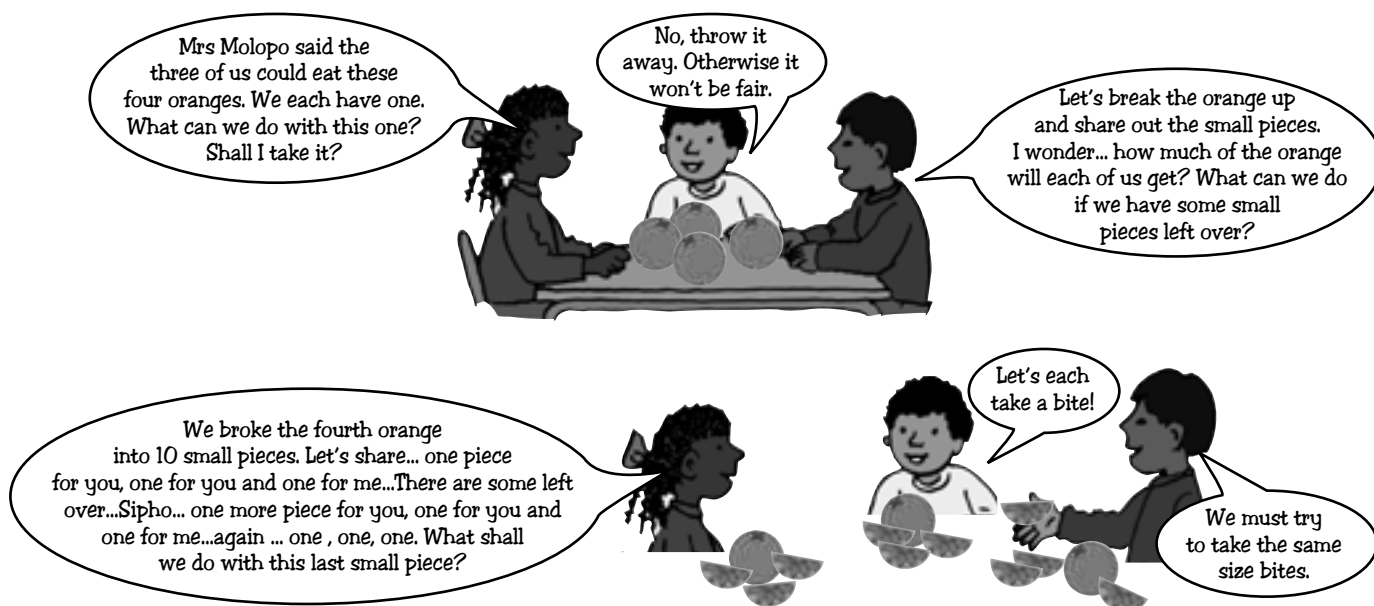

It is not necessary to introduce the terms, 'remaining' and 'remainder' until learners have had sufficient opportunities to develop their own practical understanding of these concepts. Through the year, let learners work with increasingly large numbers according to their growing understanding of numbers within the Grade 2 range. In different contexts, introduce both **equal sharing** and **equal grouping** problems.



## Grade 2: Numbers, operations and relationships

Examples:

Equal sharing problems	Equal grouping problems
1. We share 25 flowers equally between 2 children. How many flowers does each child get?	1. Mrs Pule has 25 apples. She packs bags with 4 apples in each bag. How many bags can she pack? How many apples will she have over?
2. Mother shares R10 equally between her 4 children. How much does each child get?	2. Ma Nkosi shares R40 between all her children. Each child gets R10. How many children does Ma Nkosi have?
3. Dudu, Siphwiwe and Joshua share 5 bars of chocolate equally. Draw what each child gets.	3. We need 11 children for a soccer team. 15 children come to play. How many teams can we make? How many teams with 20 children? With 25 children? 30 children? ...35 children? How many children do you need for 5 soccer teams?

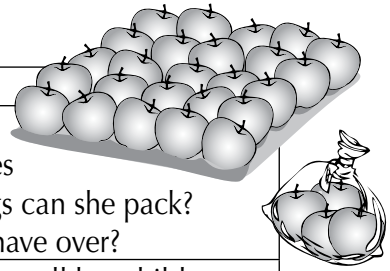

Give learners the time and the freedom to investigate and discuss these situations and challenge them to think of their own ways to share or group the various items. As learners investigate, ask guiding questions to encourage them to say what they think the result of the problem will be (estimate) before they start working – this will encourage them to begin to think more abstractly. Let learners explain what they do and what they find out and encourage them to find different practical ways to check their own and their peers' ideas.



To share R10 among four friends... We gave each friend one rand. We had R6 left over. We gave each friend one more rand. Now R2 is over. We changed the R2 into twenty 10c pieces. We kept on giving the 10 cents one-one until we shared them all out.

Each friend got two R1 and five 10c coins. That's R2,50 each when you share R10 equally between 4. We drew this picture to show what we did.

At first learners may need to work concretely to manipulate the actual objects described in the problem.

As they gain confidence and experience, they will want to find 'shortcuts' by representing and recording their methods and solutions in ways that they understand. For example, they may find it helpful to represent non-available objects with their fingers or with counters or to record their ideas in rough drawings. Many young learners find drawings easier than counters.



Depending on their prior experiences and the different ways that they think and learn, different learners will use different methods and techniques to solve and record their ideas. Do not suggest that learners who are able to imagine and represent amounts using symbols, go back to using dots or other concrete representations (but allow them to do so if they feel the need). Also do not force learners to adopt somebody else's method because it seems quicker or easier. With continued exposure, practice and growing confidence, learners will naturally try to find or adopt quicker methods that they understand. Use your judgement about when to encourage learners who lack confidence, but do understand, to draw their solutions or to use symbols to represent them.

## Grade 2: Numbers, operations and relationships

Here is an example of how different learners responded to a sharing problem:

**Child 1 (Boy):** To share 4 loaves of bread between 3 children, I gave the loaves out...one, one, one. I had one loaf over. I cut the last loaf into 3 pieces...they must be the same size. I give each learner a small piece. Each gets one whole loaf and another little bit.

**Child 2 (Girl):** I cut each loaf into three pieces of the same size. I have 12 pieces. Then I give the pieces out ... two, two, two each. I have 6 pieces left. I give them out two, two, two again. Each child gets 4 pieces.

**Child 3 (Boy):** We thought it out. We gave each child one whole loaf. We cut the last loaf into three thick slices. So each child gets 1 whole loaf and another thick slice. So we write:

- 1 bread + 1 thick slice
- 1 bread + 1 thick slice
- 1 bread + 1 thick slice

## 2. Working with fractions

At first learners use their own informal ways to describe their smaller 'pieces' or 'little bits'. This informal language may include words like 'halves' and 'quarters' that they have heard elsewhere (a quarter loaf of bread, half a dozen eggs). However, they may use any fraction name loosely to describe any piece or part of a whole. They do not necessarily understand:

- that the size of the pieces must be equal;
- how we use different fraction names to describe the number of pieces we must share the whole into.

Once learners begin to see the need to name and compare their pieces more precisely, present activities that help them develop these fundamental ideas about fractions:

### Know, understand and use fraction names

In Grade 2 we expect learners to understand and be able to describe and use **unit fractions** (one half, one third, one fifth, one twentieth).

Begin to use fraction words like 'halves', 'quarters' and 'thirds' in everyday contexts:

Share the milk fairly between the two of you so that each of you gets exactly a half.

If you share the milk fairly between the three of you, we say that you each get a third of the milk.

We will go and play outside after quarter of an hour.

Make a half turn... make a quarter turn, make a full turn.

You shared the chocolate equally between four of you. We say that each of you got a fourth or a quarter of the chocolate.

Make a necklace. Use half white beads and half blue beads ... Find different ways to pattern your beads.

## Grade 2: Numbers, operations and relationships

Present different activities and ask guiding questions to help learners develop the understanding that each fraction name tells us how many equal parts to share different wholes into. Help learners develop the language to explain that:

- to find halves we must share wholes into two equal parts;
- to find quarters (or fourths) we share wholes into four equal parts;
- to find thirds we share wholes into three equal parts;
- to find sixths we share wholes into six equal parts;
- to find tenths we share wholes into \_\_\_ equal parts;
- to find hundredths we...

You cut a chocolate bar into 2 equal pieces. What do you call each piece?

You share four apples between 4 people. How many apples does each person get? What fraction of the four apples does each person get?

You share 20 crayons between 2 friends. What fraction of the 20 crayons does each friend get?

If I share 20 crayons between two of us, I share them half-half. I get a half and you get a half. Half of 20 is 10.

Remember to include activities that help learners realise that they can use the same methods, descriptions and reasoning to find fractions of wholes that are single objects (e.g. loaf of bread or a shape) and fractions of wholes that are collections of objects (e.g. a dozen eggs or 6 single rands);

Let's see how many different ways you can fold this square into halves. How many halves will there be on each square?

These are all the ways our group found. There are two halves of the same size in each square.

You get R6 pocket money. You save a third of your money. How much do you save?

To find a third, I shared my money into 3 equal parts. So a third of R6 is R2. I save R2 every week.

Also include activities that challenge learners to explain why different shares *do not* show given fractions:

Which picture shows R4 shared into halves?... Why do you say so?

These are not halves because you shared the R4 into 4 lots, not 2 lots. You made quarters.

These are not halves because you did not share the R4 equally. This is not fair sharing.

These are not quarters. There are 4 pieces but they are not all the same size.

These are halves because you made 2 lots. Each lot has R2. They are the same.

## Grade 2: Numbers, operations and relationships

Challenge learners to make up their own problems with fractions.

As we all know fraction concepts are difficult. So give learners many opportunities to find and name fractions in different contexts and allow lots of time for them to think problems through and to discuss, compare and debate their own invented methods and their findings. This will help learners to develop the confidence to apply and generalise their knowledge to new contexts and to new problems.

So how do you think you can find a half of 12 cakes? A quarter of 12 cakes? A sixth of 12 cakes? A twelfth of 12 cakes?



Let's make a plan. To find half of 12 cakes we must share them half-half. Like this:



So half of 12 cakes is 6 cakes.



For quarters, make 4 equal groups. 3 cakes is a quarter of 12 cakes.



Sixths means share into 6 groups! So 2 cakes make a sixth. Twelfths are easy...12 groups with one cake in each group.

Challenge learners to think about how to form wholes.

How many half loaves make a whole loaf?

How many thirds of a cake make a whole cake?

Show me why you say so.

Show me why you say so.



You have some sweets in a packet. You share them among 4 friends. Each friend gets 2 sweets. How many sweets were in the packet?



You have already planted a third of your cabbages. You planted 5 cabbages. How many cabbages do you have to plant?

You spend a quarter of your pocket money. You spend R3. How much pocket money do you get?

To help learners uncover the patterns for making wholes, let them find and record their results in systematic ways in grids:

wholes	halves
1 cake	2 half cakes
2 cakes	
3 cakes	6 half cakes
4 cakes	
5 cakes	
	12 half cakes

quarters	wholes
4 quarters	1 cake
8 quarters	
12 quarters	
16 quarters	
	5 cakes
	6 cakes

Follow up on your concrete naming activities by challenging learners to reflect on what they have done and to extend and generalise their ideas further:

So, how many halves did you make from one square? .. two squares? ... 3 squares? ... 4 squares? How many halves do you think you can make from 5 squares? ... 6 squares? ... 10 squares? How do you know?



From 4 squares, we made 8 halves. For five squares, we must add 2 more halves. That's ten. For 6, add 2 more. That's 12. Wait I see a pattern. We can double. For 10 squares it will be 20.



## Grade 2: Numbers, operations and relationships

Clever thinking. So what about this? We have 1 litre of milk. We give each child a quarter of a litre. How many children can we feed from 1 litre of milk? ... 2 litres? ... 3 litres? 4 litres? How do you know?

Now think about this. We share a loaf of bread into fifths. How many children can we feed from 1 loaf? 2 loaves? ... 4 loaves? ... 8 loaves?

We share the bread into tenths. How many loaves will we need to feed 50 children?

We share the bread among 5 children. What fraction of the bread does each child get? ... How do you know? What fraction does each get if we share between 4? ... between 2? ... between 10?

When you work with shapes, go beyond tasks that simply ask learners to cut or label single shapes into halves or quarters. Give examples that challenge learners to go beyond visual judgements and develop the language they need to make and explain conclusions about the shapes. For example, here learners must say which of these drawings has one third shaded. They must explain their reasoning.

I think this last shape shows a third because, in each row, one out of the three blocks is shaded.

### 3. Comparing and ordering fractions

Introduce problems that challenge learners to compare and order fractions. For example:

Which cake is cut into halves? ... Which cake is cut into thirds? ... Which cake is cut into quarters?

You love all cake so you want the biggest piece. Which cake will you choose a slice from? ... the chocolate cake, the lemon cake or the butter cake? Why do you say so?

chocolate cake

lemon cake

butter cake

Ask guiding questions until learners can explain their choice.

To make halves, we cut the cake into 2 equal pieces, like the chocolate cake. To make thirds, we cut the cake into 3 equal pieces, like the butter cake. To make quarters, we cut the cake into 4 equal pieces, like the lemon cake. I can see that the more pieces we cut the cake into the smaller each piece is. I choose a slice of chocolate cake... It's biggest... It's cut in half. That's only two pieces.

half

quarter

third

## Grade 2: Numbers, operations and relationships

Set a variety of similar questions in different contexts to help learners practise and reinforce their comparing and ordering skills. For example: "Mary spends half an hour playing, a quarter of an hour eating and a third of an hour doing homework. Which activity does she spend the most time on? Which activity does she spend the least time on? How do you know?"

Do this work card to show what you found out.

Write these slices from smallest to biggest:

A slice of chocolate cake

A slice of butter cake

A slice of lemon cake

Write these slices from biggest to smallest:

A slice of chocolate cake

A slice of butter cake

A slice of lemon cake

Write these times from shortest to longest:

A third of an hour

A half of an hour

A quarter of an hour

Write these times from longest to shortest:

A third of an hour

A half of an hour

A quarter of an hour





### Skills and knowledge

#### The learner:

- Solves money problems involving totals and change in rands and cents.
- Uses the following techniques:
  - a) building up and breaking down numbers;
  - b) doubling and halving;
  - c) using concrete apparatus.

**Note: In Grade 2, learners can learn about place value while they count, build and represent numbers and work with money problems. For this reason, we have not addressed place value separately.**

### Suggested activities

When we work with money, one coin or note can stand for more than one thing (e.g. a R10 note stands for, or has the same value as, ten separate one rands). Do not introduce learners to combined coins until they have established stable one-to-one correspondence for the numbers involved. Once learners have done so, money becomes a useful resource for developing and consolidating various concepts such as:

- the idea that one object can represent a number of objects;
- skip counting in various multiples;
- exchanging in different ways.

**Remember to substitute of your own country's currency as appropriate.**

## 1. Becoming familiar with coins and notes and their values

First check that your learners know what our different coins and notes look like. If they have not done this work in Grade 1, or, if you want to revise and reinforce the work, let them make pencil rubbings of the different coins and then compare, describe and discuss the similarities and differences between them. For example, let them:

- feel the edges of actual coins – explain how and why they differ (to help blind people);
- discuss the details of each coin – pictures on the back and front;
- compare the sizes of coins – cut their rubbings out and arrange them in ascending and descending order according to their sizes;
- describe the symbols and numbers on the back and front of coins;
- make sure that learners understand that 5c is short for 5 cents, R10 is short for 10 rand, etc.;
- compare and sort coins and arrange them in ascending and descending order according to their values;
- use 10c coins to count in tens and 5c coins to count in fives;
- show learners examples of R10, R20, R50, R100 notes - let them compare them according to their values;
- let learners look for the watermarks on the notes - tell them why we use watermarks (to prevent forgeries);
- introduce, discuss and compare your play money - stress that this is 'pretend money' and that they cannot use it to buy anything;
- let learners use R2 coins to count in twos.

## 2. Play bartering games

This helps learners to understand why people invented money. Even if learners have played bartering games in Grade 1, it is a good idea to reintroduce these games in Grade 2. They are fun and give learners a practical understanding of why using money is such a convenient way to exchange goods.

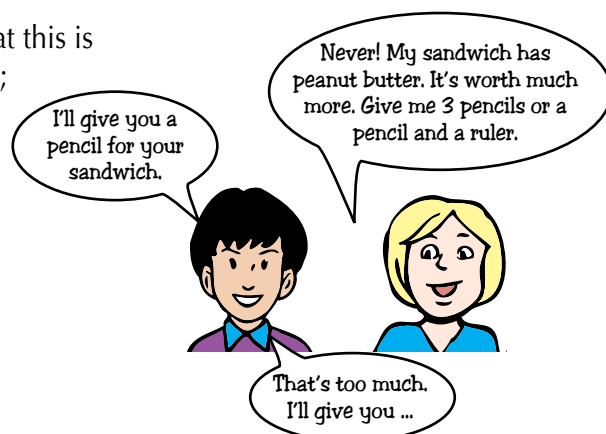

## Grade 2: Numbers, operations and relationships

Explain that, before people invented money they used to trade or barter goods. For example, if you had chickens and I had wheat we would make deals about how many chickens you should give me in exchange for a basketful of wheat. Later people started paying with goods that they saw as valuable such as shells, salt or pieces of metal.

- Learners find objects to trade at home or in the class. (e.g. pencils, books, shoes, cases, sandwiches). They negotiate trades in small groups.
- Discuss the advantages and the disadvantages of bartering e.g. we can trade what we've got but it may be difficult to decide on what is a fair exchange. Point out that, in some situations, people still barter.
- When learners understand the idea of trading, you can discuss the advantages of using money (easier to carry around than chickens or wheat; we can have fixed prices so we don't have to make deals each time).

### 3. Exchanging games

Play exchanging games to help learners become familiar with the values of our coins and notes.

- Give learners notes of different values. Learners must exchange them for the correct number of R1 coins. Let them draw and explain their exchanges.
- Later extend the game. Learners exchange their big notes (e.g. R20, R50, R100, R200) for the correct number of R10 notes, or R5 or R2 coins. They can also exchange combinations of notes (e.g. R20 + R50) in as many different ways as they can find.
- Encourage learners to uncover and use their counting patterns and techniques to record their findings systematically:



I need half the R2s each time. So I need twenty-five two rands to make R50.



	How many R2 coins?
R2	
R4	
R6	
R8	
R10	
R20	
R50	

	How many R5 coins?
R5	
R15	
R20	
	5
	6
	20
	40

- Point out that in the 'old days' we had 1c and 2c coins. Let learners use counters to represent this 'old fashioned' money. Learners exchange 5c, 10c, 20c, 50c and R1 coins for the correct number of 'old fashioned' one cent coins. Let them draw and explain their exchanges. Later they can exchange rand coins for other coins and also practise exchanging given amounts for 5c and 10c pieces.
- Then let learners break coins or notes down into as many different combinations as they can. Start with small amounts and build up systematically. You can show learners how to use 'spider diagrams' to show all their different ways to exchange different amounts.

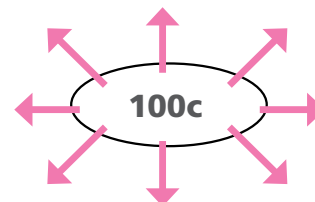

100c + 100c + R3

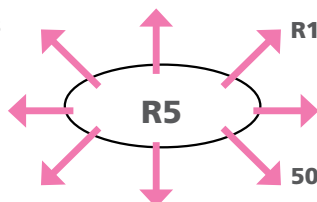

R1 + R1 + R1 + R1 + R1

50c + 50c + 50c + 50c + 50c + R2

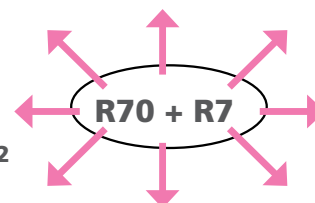

## Grade 2: Numbers, operations and relationships

- Learners should also build up to different amounts, for example, "Use 50c coins. Show me R5 ... Use R2 coins. Show me R10, R20..."
- During your mental maths sessions, challenge learners to extend patterns for making exchanges. For example, set problems like, "How many R2s in R10? ... in R20 ... in R30 ... in R40? ..."

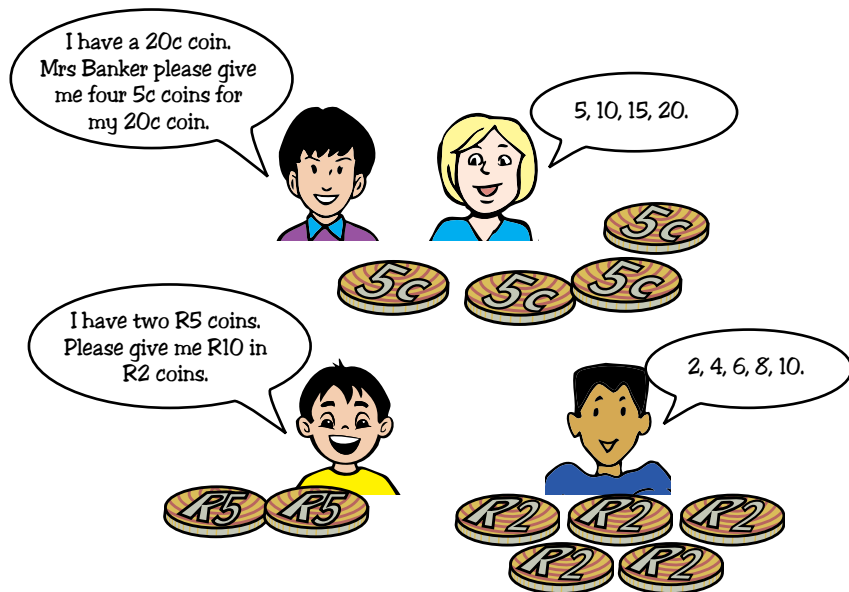

### Banking games

To reinforce these understandings, play banking games with play money. Let members of small groups take turns to be the banker. The banker exchanges the money.

Here are some examples of games:

- The banker gives each group member a different coin. For example, one group member gets a 20c coin, another gets a 50c coin and so on. Use small coins to start with and bigger coins as your learners progress.
- Learners take turns to change their coins for the correct number of 5c coins at the bank. The rest of the group checks that each learner asks for the correct amount of money and that the banker counts out the correct amount of change each time.
- Extend the game by letting the learners exchange for bigger amounts. Each learner tells the banker which coins he must give in exchange for their money. The rest of the group checks. Let learners find ways to record their exchanges and to explain their methods to each other.

### The trader's game

Make game boards on A4 paper or cardboard.

One learner is the banker. The banker controls the money and checks the exchanges. The rest of the players take turns to throw a die.

The number that the die lands on shows how many 10c pieces the banker must give that player. The player puts the 10c pieces in the last column on the board. Learners continue to take turns. After each turn they add their 10c coins.

When a player gets more than ten 10c pieces they must exchange these for a R1 coin.

When they have more than ten R1 coins, they exchange them for a R10 note.

Depending on the amount of playing time available, the winner can be the first one to make R10, R20 or R100.

R10	R1	10c

### Using spinners and play money to count in fives and twos

- Learners race to be the first to one to get R10. They take turns to spin a spinner.
- The number that the spinner lands on tells players how many 5 cents the banker must give them. After each turn players add their money. As soon as they can exchange their money for a bigger coin or note they ask the banker to make the exchange.
- They keep on spinning until one learner can exchange his or her money for, say, R10.
- To let learners practise counting in twos, change

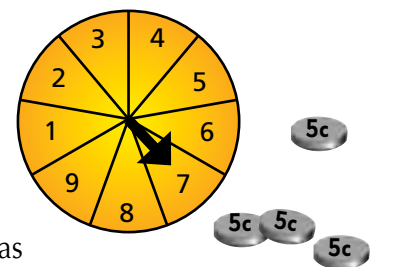

On my first turn the spinner landed on one. I got one five-cent coin. This turn, the spinner landed on 3. Banker, please give me three more five cents. I've got altogether four 5 cents. That's 5, 10, 15, 20 cents altogether. Banker, please change my four 5 cent coins for one 20 cent coin.

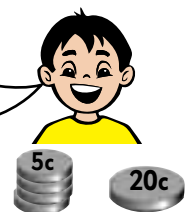

## Grade 2: Numbers, operations and relationships

the game so that the number the spinner lands on tells them how many 2 cents the banker must give them.

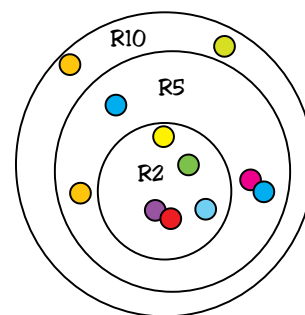

### Scatter board with money

Extend the Scatter board game by making boards that show different amounts of money. Learners must find and write their totals.

### 4. Word problems with money

Learners solve various kinds of word problems with amounts of money within the Grade 2 number range:

- Double or halve amounts of money, for example, "Mpho has R50. Tumi has double or half";
- Sharing/grouping, adding and subtracting, for example, "Your mother spends R20 on vegetables, R14 on bread and R36 on meat. How much does she spend altogether?... Ma Kgaladi shares some money equally between her three children. Each child gets R6. How much money did Ma Kgaladi have?"
- Sibongile counts her money. Write how much money Sibongile has altogether.

R		,	
---	--	---	--



- Thabo pays for a packet of chips with a R10 note. What change will he get? Tick (✓) the correct coins to show his change.

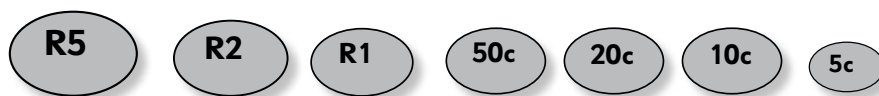

- Breaking down or building up to find change, first in either rands or cents, for example, "Mpho spends 70c. She gives the shopkeeper 80c. How much change does she get? Later with change in rands *and* cents, e.g. Mpho spends R21,50. She gives the shopkeeper R30. How much change does she get?"

Throughout, learners must explain and check their own and their peers' methods and solutions, using play money where necessary.

Work orally at first. Gradually show learners how to use the appropriate abbreviations to write amounts of money. As learners need to write amounts that combine rands and cents, make sure that they understand how we use the comma to separate rands from cents.

### Skills and knowledge

#### The learner:

- Can perform calculations, using appropriate symbols, to solve problems involving:
  - a) addition and subtraction of whole numbers with at least 2 digits;
  - b) estimation.
- Performs mental calculations involving:
  - a) addition and subtraction for numbers with solutions to at least 20;
  - b) multiplication of whole numbers with solutions to at least 20.
- Uses the following techniques:
  - a) building up and breaking down numbers;
  - b) doubling and halving;
  - c) using concrete apparatus;
  - d) number lines.
- Explains own solutions to problems.
- Checks the solutions given to problems by peers.

### Suggested activities

As with sharing and grouping, help learners to develop addition, subtraction and multiplication skills by presenting them with a wide variety of relevant practical problems that relate to their lives.

#### Practical problem solving

We present problems for the different operations (adding, subtracting, multiplying and sharing/grouping) separately to illustrate the different problem types for each operation clearly. However, it is not necessary to teach them separately and in strict order (first adding, then subtracting, then multiplying then sharing and grouping).

You will find that, if you start by introducing challenging problems, different learners may use different operations, in different ways, to solve them. They may solve what you think of as an 'addition problem' by subtracting or a 'multiplying problem' by repeated addition. They will also use different techniques and skills. In this way learners learn to fall back on their own resources to discover and use number facts.

#### Finding the right problems

The level of the problems you set must cater for the different needs and levels of all the learners in your class. One way to do this is to build up sets of simple work cards that challenge learners at different levels. There are a number of ways to adjust problems to challenge learners appropriately:

- Use different contexts to adapt the problems to your learners' interests, and home and school environments. This helps them discover how to use and extend their number knowledge and the techniques in different situations that are meaningful to them.
- Increase or decrease the size of the numbers to match different learners' number knowledge and your grade level.

Piet has 25 marbles. Simangi has 19 marbles. How many more marbles does Simangi need to have the same number of marbles as Piet?

This is what I wrote.

I counted on, like this.

25 – 20 is 5.  
5 and 1 more is 6.

19 to 20 is 1.  
20 to 25 is another 5... 1 + 5 is 6.



## Grade 2: Numbers, operations and relationships

- Use different problem types. The four main problem types for adding and subtracting are: change problems, comparing problems, equalising problems and combining problems (see the table on the next page for examples).
- To encourage learners to use their knowledge and skills for building up and breaking down numbers in different ways, change the position of the 'unknown' (the part of the problem that your learners must find out) in each type of problem. Here are three ways to change the position of the unknown:

**Start unknown** - Place the unknown at the start of the problem.

"Mpho has some biscuits. Sam gives him 4 more biscuits. Now Mpho has 12 biscuits. How many biscuits did Mpho start with?"

We can represent these types of problems mathematically like this:

$$\square + 4 = 12$$

Do not introduce these formal equations to start with. Learners will gradually learn to read and write them as you help them to extend their own early, informal ways to read and write maths.

**Change unknown** - The unknown is in the middle:

$$8 - \square = 1$$

For example, "Jan had 8 marbles. He loses some to Popo. He has only 1 marble left. How many marbles did Jan lose?"

**Result unknown** - The unknown is in this position:

$$2 + 5 = \square$$

For example: "To get to school, Lesego walks 2 km to the bus stop and then travels 5 km on the bus. How far is Lesego's school from his house?"

### Number techniques and skills

You can also present word problems that will encourage learners to use, extend and practise their number techniques and skills:

- **Building up and breaking down numbers**  
For example, "You have R37. Find as many different ways as possible to share the R37 between two people (e.g. R17 for one person and R20 for the other; R19 plus 18, etc). And between 3 people?"
- **Doubling and halving**  
For example, "David starts with R80. Every day he spends half the money in his pocket. After how many days will he have only R5 left?"  
"Susan makes 5 sandwiches on Monday. On each day of the week she makes twice as many sandwiches as the day before. How many sandwiches will she make on Saturday?"
- As learners build understanding of how to use **number tracks and number lines**, they may choose to use them as aids to solve and record their solution methods. For example, a learner may work out Lesego's distance problem (above), like this:

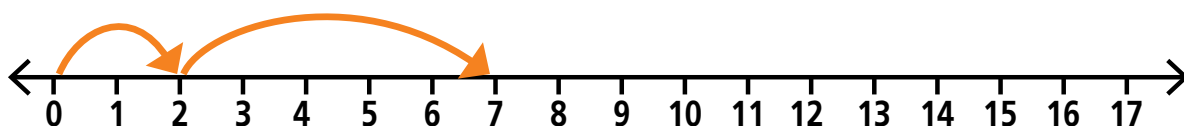



## Grade 2: Numbers, operations and relationships

Here are examples of the main types of adding and subtracting problems you should introduce to Grade 2 learners. Notice that the problem types are the same as those suggested for Grade 1. We change them to meet Grade 2 requirements by increasing the number range appropriately.

### Main problem types for addition and subtraction

Change problems	
<b>Start unknown</b> $\square + 29 = 49$ or, $\square - 25 = 15$	1) Mpho has some biscuits. Sam gives him 29 more. Now Mpho has 49 biscuits altogether. How many biscuits did Mpho start with? 2) Mpho's mother has some money. She spends R25. She has R15 left. How much money did Mpho's mother start with?
<b>Change unknown</b> $38 + \square = 41$ or, $38 - \square = 3$	1) Jan has 38 marbles. He buys some more marbles. Now Jan has 41 marbles. How many marbles did he buy? 2) Jan has 38 marbles. He loses some to Popo. He has only 3 marbles left. How many marbles did he lose to Popo?
<b>Result unknown</b> $57 + 14 = \square$ or, $45 - 9 = \square$	1) To get to his farm, Mr Ncube travels 57 km by train and travels 14 km by bus. How far does Mr Ncube travel? 2) Lesego had 45 crayons. He gives 9 to Katlego. How many crayons does he have left?
Comparing problems	
<b>Start unknown</b> $\square = 32 + 9$ or, $\square = 32 - 4$	1) Mrs Randerer has a bigger Grade 2 class than Mr Dlamini. She has 9 more learners than Mr Dlamini. Mr Dlamini has 32 learners. How many learners does Mrs Randerer have in her class? 2) Mrs Smit has a smaller Grade 2 class than Mrs Tshongwe. She has 4 less learners than Mrs Tshongwe. Mrs Tshongwe has 32 learners. How many learners does Mrs Randerer have in her class?
<b>Change unknown</b> $47 - \square = 40$ or, $12 + \square = 47$	1) Jan has 47 sweets. Dan has 40 sweets. How many more sweets does Dan have than Jan? 2) Jan has 47 sweets. Dan has 12 sweets. How many fewer sweets does Dan have than Jan?
<b>Result unknown</b> $37 - 4 = \square$ or, $100 + 4 = \square$	1) Jan has 37 sweets. He has 4 more sweets than Dan. How many sweets does Dan have? 2) Jan has 100 sweets. He has 4 fewer sweets than Dan. How many sweets does Dan have?
Equalising problems	
<b>Start unknown</b> $\square = 53 - 10$ or, $\square = 23 + 20$	1) Sue and Simangi have a hopping competition. Sue wins by 10 hops. She hops 53 times. How many times did Simangi hop? 2) Sue and Simangi have a hopping competition. Sue loses by 20 hops. She hops 23 times. How many times did Simangi hop?
<b>Change unknown</b> $11 + \square = 27$ or, $42 - \square = 37$	1) Sue hops 27 times. Simangi hops 11 times. How many more times must Simangi hop to catch up to Sue? 2) Sam hops 37 times. Sue hops 42 times. Who makes less hops? How many less?

## Grade 2: Numbers, operations and relationships

<p><b>Result unknown</b>  <math>59 + 3 = \square</math>  or,  <math>59 - 3 = \square</math></p>	<p>1) Simangi hops 59 times. Sue must make 3 more hops to catch up to Simangi. How many hops does Sue make?  2) Simangi hops 59 times. Sue makes 3 less hops than Simangi. How many hops does Sue make?</p>
<b>Combining problems</b>	
<p><b>Start unknown</b>  <math>\square = 25 + 25</math></p>	<p>Ranjit has some sweets. 25 of his sweets are toffees. 25 of his sweets are jelly babies. How many sweets does he have?</p>
<p><b>Change unknown</b>  <math>18 + \square = 35</math></p>	<p>There are 35 children in the class. 18 are boys. How many are girls?</p>
<p><b>Result unknown</b>  <math>55 + 22 = \square</math></p>	<p>Ranjit travels for 55 minutes to Grootvlei and for 22 minutes to Mpani. How long does his whole trip take?</p>

### Reasoning, discussing and checking

- Give learners the time and the freedom to work in pairs or in small groups to investigate and discuss these situations.
- Encourage learners to estimate the result of the problems before they start working – this will encourage them to begin to think more abstractly by imagining the problem situations and their outcomes.
- Challenge them to think of their own ways to solve problems, using their available number knowledge and skills (e.g. counting in different ways, place value, exchanging money) and number techniques (building up and breaking down numbers, doubling and halving, concrete apparatus, number lines). Expecting learners to use symbols and formal calculating methods from the beginning confuses and demotivates them.
- To expose your learners to different ideas about how to solve problems, let them take turns to use their own informal language to share and explain what they do and what they find out. Remember that, for most of us, home language is our most powerful learning and thinking language.
- Encourage learners to listen carefully to each other's explanations and to find different practical ways to check their own and their peers' ideas and calculation methods. Where necessary, ask guiding questions to help them clarify and extend their ideas.



This is my quick way to add 14 and 17. I double 14 ... that's 28, and then add 3 more. 29, 30, 31.

$14 + 17 = 31$



To find 36 minus 19, I say - half of 36 is 18 and take away 1 more. Leaves me with 17.

$36 - 19 = 17$

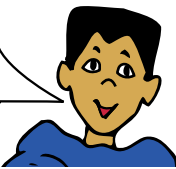

I found a different way to take 19 from 36. I first said 36 take away 20 ... leaves 16. But I took away one too many. So I must add it in again. So that's 17 left.

## Grade 2: Numbers, operations and relationships

### Other ways to represent problems

- At first learners may need to work concretely to manipulate actual objects or aids to help them check and understand.

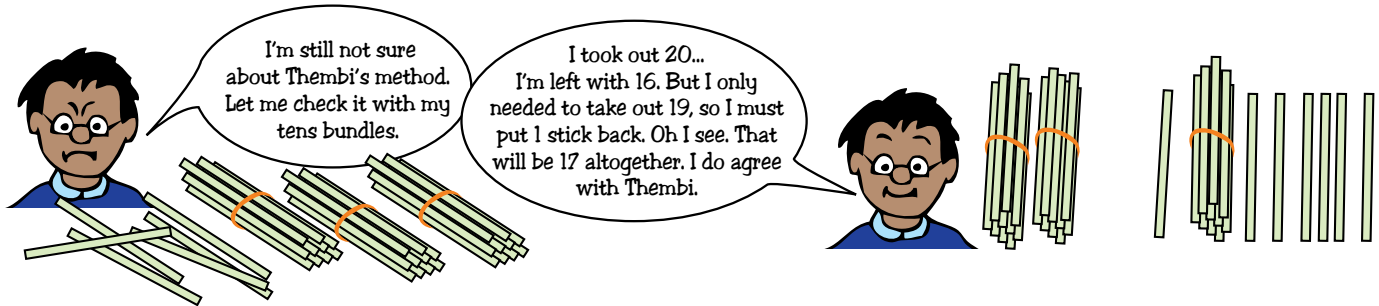

- As they gain confidence and experience, learners will want to find 'shortcuts' to **represent and record** their methods and solutions in ways that they understand. As you observe, assess how different learners are thinking and what support they need. Also judge when learners are ready to be encouraged to refine and move from their early informal solution and recording methods to more compact and formal methods.
- As you see that various learners understand and are confident with the new maths ideas, gradually introduce appropriate maths terms and symbols that will help them use shorter ways to represent their ideas.
- To check that learners understand the symbols, ask questions like:

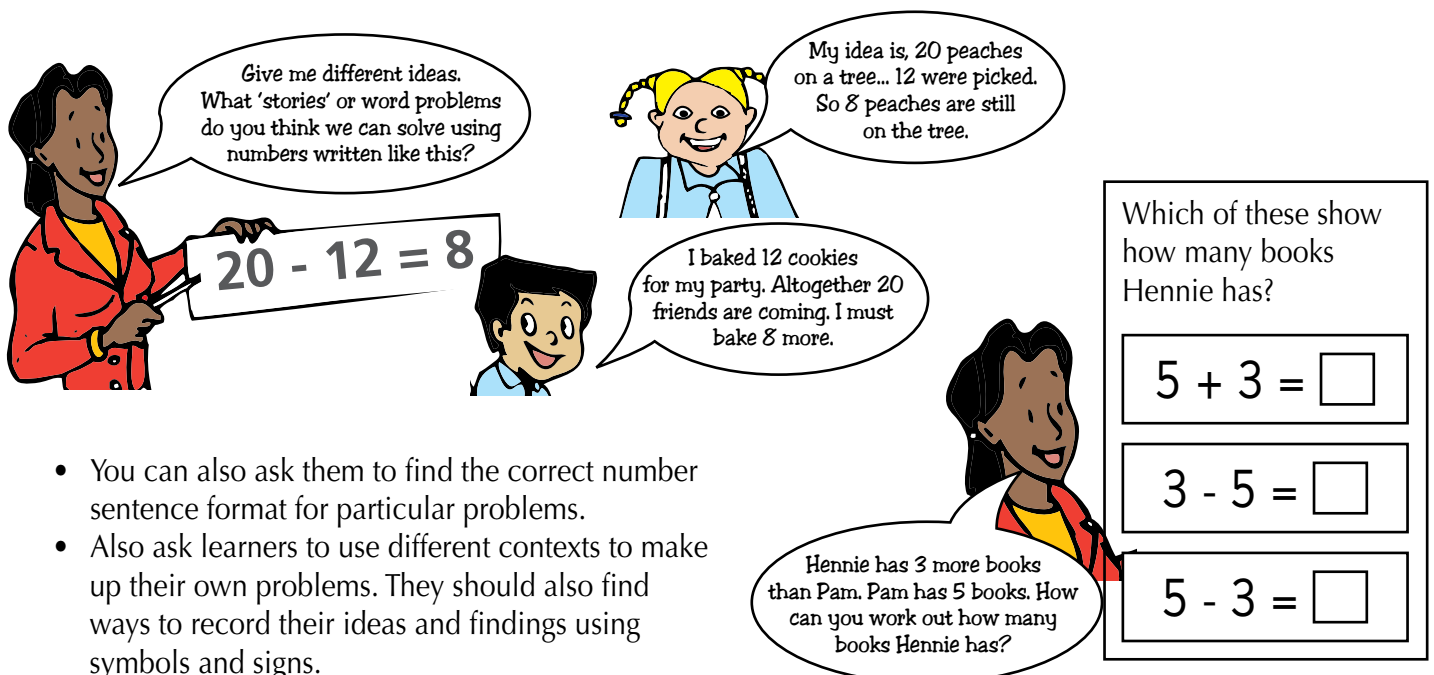
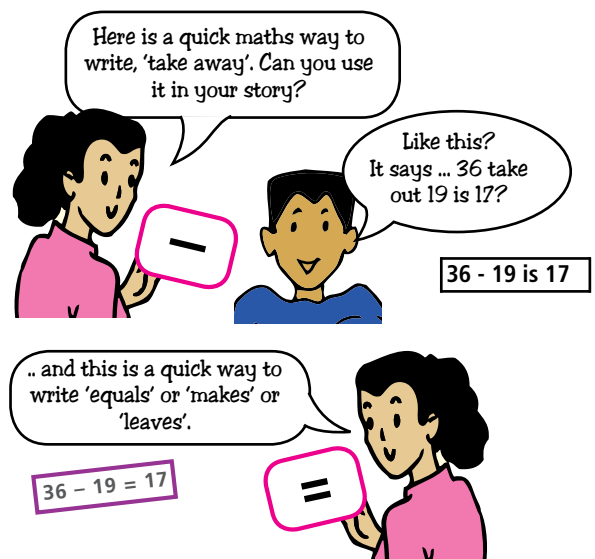

- You can also ask them to find the correct number sentence format for particular problems.
- Also ask learners to use different contexts to make up their own problems. They should also find ways to record their ideas and findings using symbols and signs.

## Grade 2: Numbers, operations and relationships

- Introduce learners to other mathematical formats that will help them to organise their ideas systematically.  
For example, they can show how they break the numbers up to add, like this: Or like this:

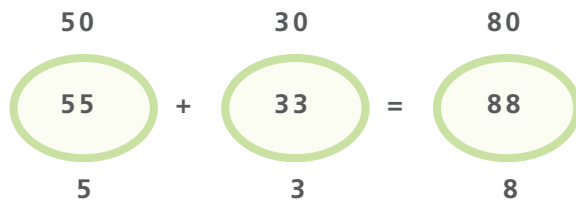
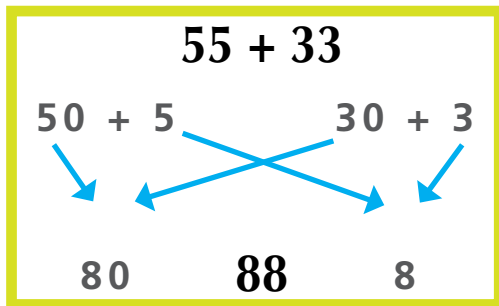

Once learners have had lots of this kind of practice, show them how to write their numbers underneath each other.

$$\begin{array}{r} 50 + 5 \\ + 30 + 3 \\ \hline 80 + 8 = 88 \end{array}$$

**Adding**

$$\begin{array}{r} 50 + 5 \\ - 30 + 3 \\ \hline 20 + 2 = 22 \end{array}$$

**Subtracting**

This is an important stepping stone that will help learners to understand and use the shorter, vertical methods that are required in Grade 4.

$$\begin{array}{r} 55 \\ + 33 \\ \hline 88 \end{array}$$

**Remember:**

Never force learners to adopt somebody else's method because it seems quicker or easier. With continued exposure, practice and growing understanding and confidence, learners will naturally try find or adopt quicker methods that they understand to illustrate their thinking.

## Skills and knowledge

### The learner:

- Can perform calculations, using appropriate symbols, to solve problems involving:
  - a) multiplication of whole 1-digit by 1-digit numbers with solutions to at least 50;
  - b) estimation.
- Performs mental calculations involving:
  - a) addition and subtraction for numbers to at least 20;
  - b) multiplication of whole numbers with solutions to at least 20.
- Uses the following techniques:
  - a) building up and breaking down numbers;
  - b) doubling and halving;
  - c) using concrete apparatus;
  - d) number lines.
- Explains own solutions to problems.
- Checks the solutions given to problems by peers.

## Suggested activities

### The steps of learning about multiplication

As with the other calculation methods, help learners to develop multiplication skills by presenting them with a wide variety of relevant experiences that will help them build up understanding of the mathematical relationships. Provide opportunities that:

- Help learners to build on their previous counting, adding and patterning experiences – particularly counting objects in different multiples and adding the same amount repeatedly. For example, counting parts of the body, finding patterns for counting in twos, fives and tens on number boards, number charts, number lines and play money. Let them investigate and answer questions like, “Four children, how many eyes? ... ears? ... legs? ... You have six R2 coins. How much money altogether?”

We counted in 2s up to 50. What do you think the next number in the 2s counting pattern will be?.. and the next ... and the next. How do you know?

You put your counters out to find the patterns for counting in 2s, 5s and 10s. Use tables to show and continue the patterns for all these counting patterns.

Counting in 2s				
2	4	6	8	10
12	14	16		

Counting in 5s	
5	10

Counting in 10s

## Grade 2: Numbers, operations and relationships

- Help learners to use and extend these counting and patterning skills by posing a variety of practical problems that encourage them to count in multiples and/or do repeated addition.

Here are examples of some different multiplication types you can use in Grade 2.

Problem type	Examples
<b>Repeated addition</b>	a) Mother gives each of her 4 children 2 sandwiches for their school lunch. How many sandwiches must she make altogether? b) There are 4 oranges in each bag. You buy 3 bags. How many oranges did you buy?
<b>Rate</b>	a) You get R3 pocket money each week. How much money do you get in February? b) The Dlamini family eats 2 loaves of bread every day. How much bread do they eat in 3 days?
<b>Grids</b>	a) Jabu plants 5 beans in a row. She plants 3 rows of beans. How many beans does she plant altogether? b) There are 4 desks in each row. There are 6 rows of desks in the class. How many desks are there in the class altogether?

- Link your repeated addition work to sharing and grouping by changing the position of the unknown in the problems. For example, extend the 'sandwich problem' by asking related questions like: "For the class outing, Mother makes 24 sandwiches altogether. How many children can each get two sandwiches?"
- Start with small numbers (e.g. 2s then 3s) and gradually build up the numbers in each group and the number of groups.
- Encourage learners to *estimate* the result of the problems before they start working.
- At first, let learners represent their problem solving methods and their solutions concretely by putting out equal groups of objects to represent the different groups. Let them label their groups with number cards and find the totals. Ask guiding questions to help learners develop the language to describe and explain what they do and what they find out.
- Encourage learners to use simple drawings to show how they count or combine equal groups. Show them different ways to label their drawings. Stress that they must always write the final amount (the answer). The written methods you model must match individual learner's counting methods. For example, for the problem, "Four children, how many eyes?", depending on what learners say, you can model counting in 2s or repeated addition as follows:



How many in each row? ...  
How many rows did you make?  
... How many altogether in 5 groups of 3?

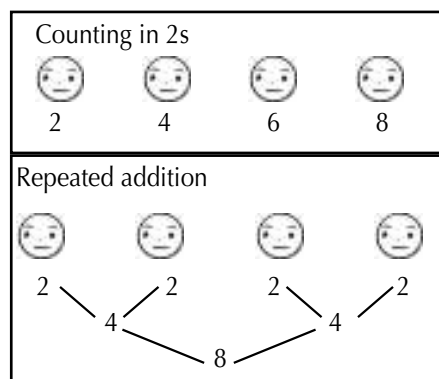

At a later stage you can model how they can use the addition and equals sign for repeated addition:

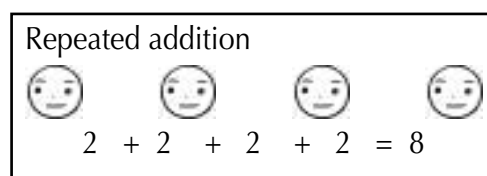



# Grade 2: Numbers, operations and relationships

- To help learners develop understanding of their multiplication number facts, introduce problems that encourage learners to think about all the different ways to put the same number of objects out in equal groups. Let them explain their different ways of making equal groups and of writing their methods to each other.

Ma Kgaladi sells oranges at her fruit stall. Today she has 12 oranges. She puts the same number of oranges on each plate. How many different ways can she put out her oranges?



First I tried 2 oranges in a plate. I counted on my fingers... 2 that's one plate, 4 that's 2 plates, 6 that's 3 plates, 8 that's 4 plates, 10 that's 5 plates, 12 that's 6 plates. I drew my plates like this.

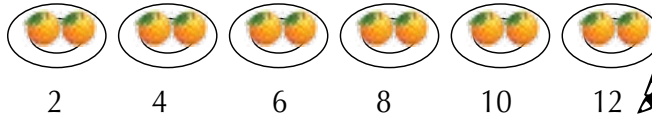

Good, so under your plates we can write this.



Let's write what you did under your other drawings. Tell me what you did each time.

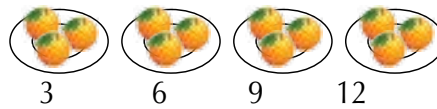

First I made 6 plates with 2 oranges in a plate. Five plates didn't work because I had oranges over. So I made 4 plates with 3 in a plate... then 3 plates with 4 each ... 2 plates with 6 each because I know  $6 + 6 = 12$ . At the end I put one-one in 12 plates.

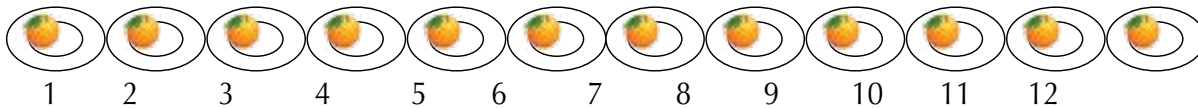
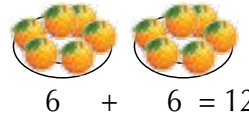
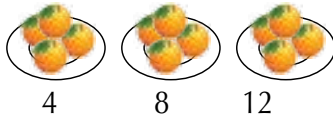

Now Kevin, tell me what you did each time.



I used 12 counters each time. Let me draw how I put my counters each time.



3 lots of 4



4 lots of 3



2 lots of 6



6 lots of 2

I didn't think of putting them one-one like Mpho did. Can I add that idea to my drawing?



Good idea!



I drew 12 counters and put rings around to show the different groups Ma Kgaladi can make. I wrote the different groups. I also did not think of 12 groups of one each.



3 groups of 4  
4 groups of 3  
2 groups of 6  
6 groups of 2

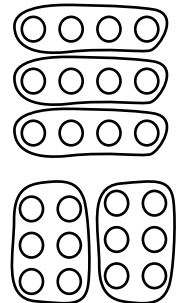

I remembered how we used shapes to break numbers up for adding. So I used shapes to break numbers into equal groups. I did think of 12 of one each, but I couldn't draw a nice 12-sided shape.

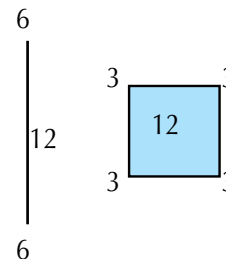
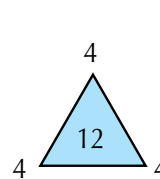

You all found different ways to arrange the oranges and to write what you did. Did you notice what was the same in what you all did?



Our groups were nearly the same. We found 3 lots of 4 and 4 lots of 3... then there were 2 lots of 6 and 6 lots of 2.



Don't forget my 12 lots of 1. Hey, I notice that we can turn the numbers around. So we can also say one group of 12.



## Grade 2: Numbers, operations and relationships

I notice you can turn the numbers around between sharing and multiplying. 4 taken 3 times is 12. 12 shared between 3 people... they will each get 4 and 12 shared between 4... each will get 3.



What interesting patterns! I wonder if you can always turn the numbers around when you break them into equal groups.

Let's investigate. Mpho and Kevin find out what happens with 6 oranges, Tumi and Kelibogile find out what happens with 24 oranges.



- When your learners become confident with calculating and recording equal groups, you can introduce the symbols and the standard language (multiply) as short ways to explain and write what they have done.



Here is a quick maths way to write 'groups of' or 'lots of' or 'multiply by'. Who can read what this says? Give me some story sums for this number sentence.

$$4 \times 3 = 12$$

- As learners begin to use this format, look out for learners who make the common errors of *adding* the two numbers in multiplication number sentences. Give these learners more experience of linking the repeated addition format to the multiplication format.
- Group 12 into fours. Draw the pictures. Write the addition and multiplication sums.

$$\begin{array}{ccccccc} \boxed{\square} \boxed{\square} \boxed{\square} \boxed{\square} & + & \boxed{\square} \boxed{\square} \boxed{\square} \boxed{\square} & + & \boxed{\square} \boxed{\square} \boxed{\square} \boxed{\square} & = & 12 \\ 4 & + & 4 & + & 4 & = & 12 \\ & & 3 & \times & 4 & = & 12 \end{array}$$

- You can also show learners how to use tables to record multiplication patterns and relationships.

<b>weeks</b>	1	2	3	4	5	6	7
<b>days</b>	7	14					

### How many legs?

	<b>1</b>	<b>2</b>	<b>3</b>	<b>4</b>	<b>5</b>	<b>6</b>	<b>7</b>
<b>children</b>	2	4					
<b>three-legged cooking pots</b>	3	6					
<b>chairs</b>	4						
<b>spiders</b>	8	16		32			

## Skills and knowledge

### The learner:

- Performs mental calculations involving:
  - a) addition and subtraction for numbers with solutions to at least 20;
  - b) multiplication of whole numbers with solutions up to at least 20.
- Uses the following techniques:
  - a) building up and breaking down numbers;
  - b) doubling and halving.
- Explains own solutions to problems.
- Checks the solutions given to problems by peers.

## Suggested activities

### 1. Developing mental tasks

As learners build maths knowledge they will gradually become more and more able to work mentally. To support this growth we should, on a daily basis (for about 10 to 15 minutes), present learners with different kinds of mental tasks that:

- Interest, motivate and challenge them to think and to find their own ways to calculate mentally.
- Help them to use what they know to see patterns, derive new facts and ideas and to use and practise their knowledge to solve problems.
- Link their mental activity to the maths concepts and contexts they have been developing (e.g. money, time, informal measurement, equal sharing and grouping, adding and subtracting, multiplying). For example, if learners are working with breaking up numbers up to ten, you may ask:

You told me that 2 plus 32 is 34 and that 42 plus 2 is 44. What do you think is the answer to  $52 + 2?$  ... to  $62 + 2?$  ... How about  $94 - 2?$  ...  $84 - 2$  ...  $74 - 2?$  ...  $64 - 2?$

You found out that 2 threes are 6 and 4 threes are 12... Can you tell me what 8 threes are? ... 16 threes?

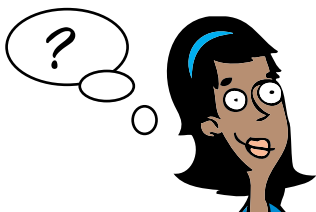

I'm thinking of a secret number. I add 14 to my number. I get 54. What is my secret number?

You can then link this number knowledge to different kinds of related word problems.

There are 44 children in Grade 2 at this school. Thirty of the children are boys. How many are girls?

It is five o'clock. What will the time be in five minutes? ... ten minutes? ... 45 minutes?

You can also integrate these sessions to challenge learners to work mentally with aspects of other mathematical contexts. For example, if you are working with shapes, your mental activity might encourage learners to visualise and name them.



The object I am thinking of is a box. Four of its faces are rectangles. One other face is a square. What shape will the last face be? Draw the last face. Tell your friend the name of the shape. Find a box like the one I am thinking of in the classroom.

### 2. Organising your mental maths sessions

Mental maths sessions should be thinking sessions rather than rote memory or speed sessions that only require learners to give accurate answers as quickly as possible. Ensure that everybody in the class becomes involved - not only those learners with quick recall who may distract everybody else by waving their hands, clicking their fingers and/or shouting to get your attention. Through your actions, show that you respect all learners, and aim

## Grade 2: Numbers, operations and relationships

to build their confidence and ability. For example:

- Provide thinking time during which everybody must think or work quietly.
- Set rules like: “Nobody should put their hand up before I give you the signal” or, “If you know the answers, you can raise your thumb quietly to show me you have the answer!”
- Call for answers and explanations from anyone – not only those who raise their hands.
- Let learners discuss and share their different thinking methods with the whole class.

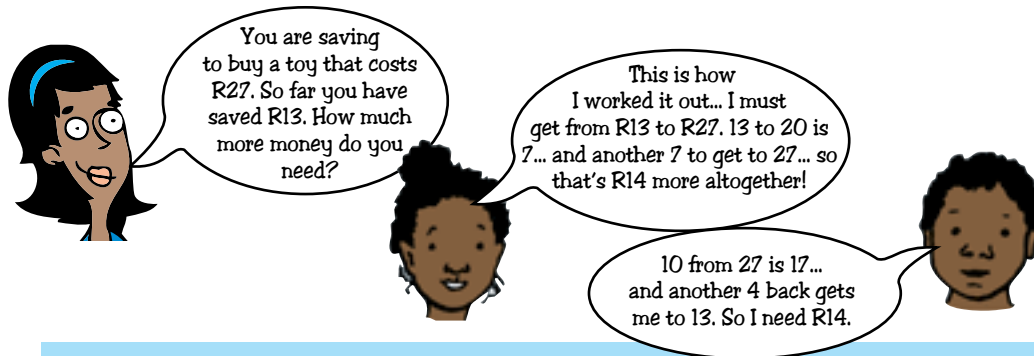

Working mentally also helps learners improve their calculating speed. Think, for example, how much quicker the invented methods that the learners in the example used are than if they were to write a calculation like this:

$$\begin{array}{r} 27 \\ -13 \\ \hline 14 \end{array}$$

- Show that you accept different ways of thinking – as long as they make sense.
- As learners develop ways to calculate and solve problems, encourage them to speed up their responses.
- Let learners write only the answers on a scrap of paper, or on a small white board or a slate. Ask questions one by one, allowing learners time to think. Show learners how to write their answers in an organised way (e.g. numbering their answers). Learners can hold up their boards after each question – when you give the signal. This encourages all learners to think and it helps you to assess learners' performance informally.
- Once learners can read fairly fluently, present a series of linked questions in written form (e.g. on work cards). Learners can then work independently or in small groups to write the answers.

## Grade 2: Numbers, operations and relationships

### Vocabulary

Note: If you do not teach in English, use equivalents in your language of instruction.

#### Grade 1:

- number names (one, two, etc.)
- ordinal number names (first, second, third, etc.)
- more , less, fewer, as much as, a little, a lot
- same, different
- equal, about, nearly, none
- total, altogether, count
- cents, rands, exchange
- pieces, parts, share, group, share equally, share between, among
- equal shares (or parts)
- break up
- estimate
- put together, add, build up, break down, take away, subtract, (minus)
- double, halve,
- number names up to 100
- count in tens.

#### Grade 2 – add the following to the Grade 1 vocabulary:

- fives, twos, odd numbers, even numbers
- fraction names e.g. half, halves, quarter(s), fourths, thirds, fifths, sixths, one and a half, two and a quarter
- wholes, parts, pieces, left over, remains, remainder
- twice, three times (etc), multiply by.

#### Grade 3 – add the following to the Grade 1 and 2 vocabulary:

- number names up to one thousand
- tens, units, ones
- twenties, twenty-fives, fifties, hundreds.

### Resources

- objects in learners' environment, different counters (e.g. bottle tops, beans, used matchsticks, plastic shapes, pencils, washing pegs, buttons, unifix blocks, leaves, sticks, stones)
- body parts (eyes, ears, limbs, fingers)
- number tracks and number lines
- number charts or boards, number cards
- sandpaper numbers
- play money
- worksheets
- calendars
- number spinners.





# Grade 2: Patterns, functions and algebra

The learner will be able to recognise, describe and represent patterns and relationships as well as to solve problems using algebraic language and skills.

## Skills and knowledge

### The learner:

- Copies and extends simple patterns using physical objects and drawings.
- Creates own patterns.
- Describes observed patterns.
- Identifies, describes and copies geometric patterns in natural and cultural artefacts of different cultures and times.

The vocabulary that learners need to understand and use for these skills is listed at the end of the suggested activities. You will find it helpful to make flash cards with key vocabulary words to support the teaching and learning process. A list of the resources you will need for the activities is also provided.

## Suggested activities

### Beginning with patterns

Young children encounter patterns in many different situations as they venture out into the world. From early on they observe both natural and man-made patterns and find their own ways to describe and make meaning of them. Patterns help them to order their world and experiences.

As educators, our challenge is to find opportunities to expose our learners to many different kinds of patterns and to design learning experiences where they can investigate these patterns further, both in the Mathematics class as well as in music, art and language classes.

The activities you design should help learners to:

- see the relationships between the elements of a pattern;
- identify similarities and differences in patterns;
- observe how patterns repeat, change or grow in different ways.

Through these experiences your learners will develop the vocabulary and language they need to communicate, share and build on their pattern experiences and apply what they have learned to other learning areas and contexts.

While we have separated the activities in the unit into shape and number patterns, it is obvious that shape patterns intersect with number patterns. For example, as learners count and compare how many shapes or pictures there are in different designs and patterns, and look for rules in their structure, they are using different number skills and finding out about number relationships.

Also refer to our Shape and Space activities for ideas about ways to integrate shape and pattern work. For example, learners can develop understanding of how to use patterning techniques to construct symmetrical shape patterns.

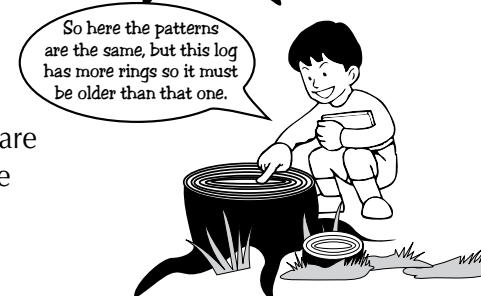

### Preparing the classroom

Display weather charts, calendars, birthday charts and life cycle charts in your classroom. By observing and interacting with these, learners will come to understand about growth patterns and natural patterns that occur in ever-repeating cycles.

Point out how a calendar is arranged in a pattern, where the days repeat themselves in cycles of 7.

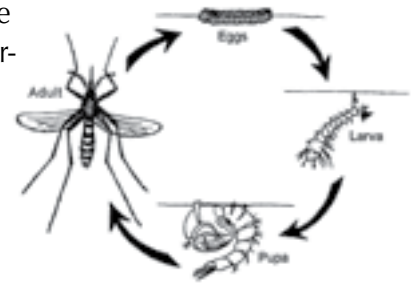

Mon	Tues	Wed	Thurs	Fri	Sat	Sun
	1	2	3	4	5	6
7	8	9	10	11	12	13
14	15	16	17	18	19	20

Ask learners to subtract the top date from the bottom date in each row and to try and explain why the answer is always 7. (Because the calendar week is arranged in a repeating cycle of 7 days.)

### Pattern posters

Collect pictures that contain different kinds of patterns – ones that contain patterns made by people (including cultural patterns), as well as pictures containing natural patterns.

Here are some examples to include:

#### Natural patterns



The symmetrical pattern of a leaf.



Wind patterns in the sand.



Patterns in flower formations.

#### Made patterns



Symmetrical designs in African artefacts.



Patterns found in different clothing and textiles.

Talk about the different kinds of patterns, encouraging learners to describe their unique features, their similarities and differences. Ask them to look out for examples of different patterns in the classroom, e.g. brick patterns, tiling patterns, roof patterns and patterns in window frames.

## Grade 2: Patterns, functions and algebra

### Gift wrap patterns

Collect examples of different kinds of gift wrapping or wall paper and have learners work in groups to investigate and talk about the different patterns they see. Make time for each group to share their patterns with the rest of the class.

All the rows are the same. In each row, first the curly design points left, then right, then comes the circle. Then the curly design points left, then another points right and then the circle again.

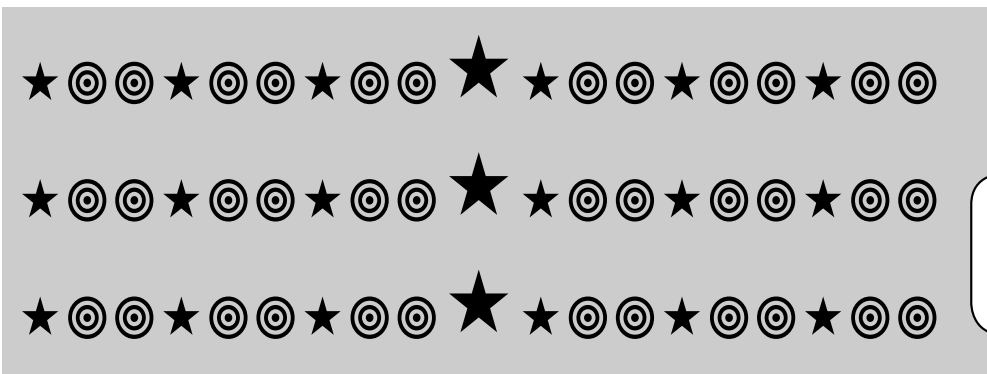
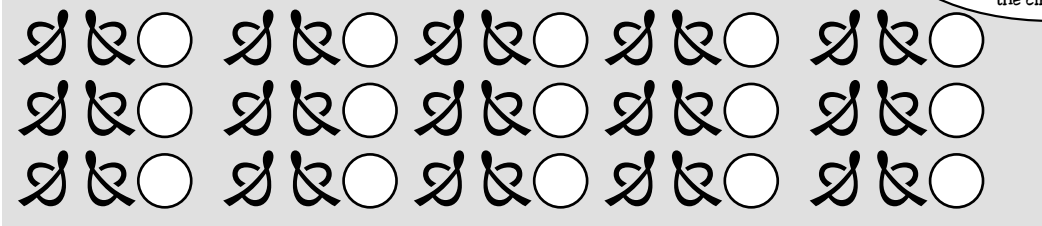
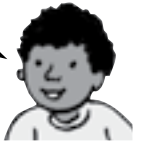

In our pattern each row is also the same. But our pattern is made from a star, two circles, a star and two circles, another star and two circles, then a big star in the middle. Then the same pattern carries on like before. The big star is in the middle of the row.

Also try to include examples of shapes and pictures that are arranged where there's no particular pattern - other than that the same set of pictures might repeat themselves in one sheet of paper.



Learners should be able to explain differences between non-patterns like these, made with a random arrangements of shapes or pictures and the previous examples, where there is a definite pattern formed by a sequence of repeating pictures or objects.

### Drawing and copying patterns

Give learners plenty of opportunities to reproduce their own patterns by drawing them, painting them using lino-cuts, potato cuts or stencils and then describing and comparing the patterns they've made.

### Growing patterns

#### In nature

Log patterns or the pattern formed by rings of water are examples of growing patterns in nature. The rings from the centre outwards get bigger each time:

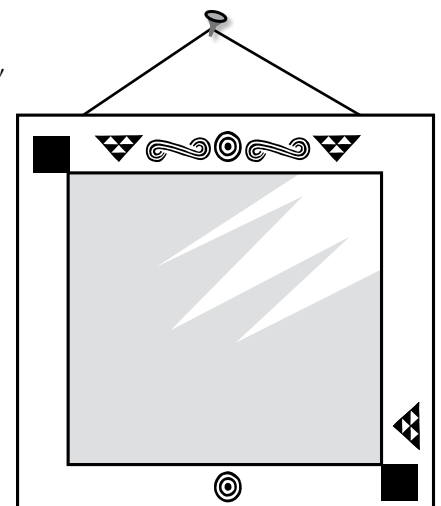

## Out and about

Take a walk together around the school grounds to look for different kinds of patterns - both natural and made by humans. Give different learners the chance to describe and compare the patterns using their own language and vocabulary.

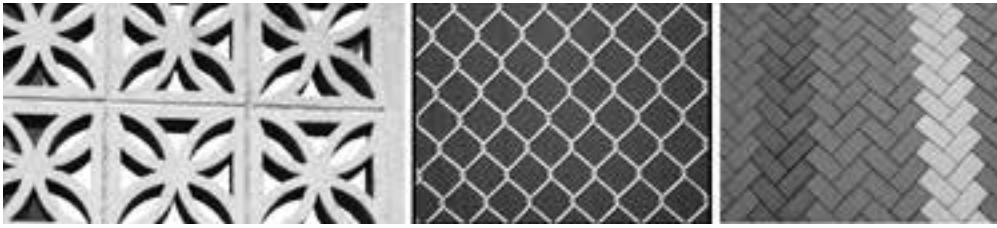

In a follow-up art lesson, let learners draw and make models of some of the patterns they observed outside using different materials like pencils, kokis, paints, paper strips or clay.

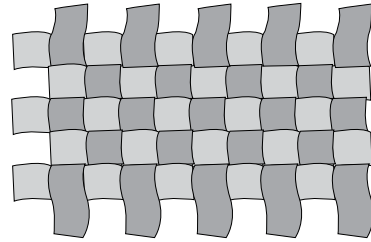

## Patterns and rhythm

- Begin a rhythmic pattern by clapping and stamping your feet and then ask learners to join in:

clap, stamp, stamp, clap (pause) clap, stamp, stamp, clap (pause)

Learners can then take turns to make up their own clapping and stamping patterns that the rest of the class or group must copy and repeat.

- Play a scale up and down on a piano, recorder or harmonica. Ask learners to sing along with you and try to 'feel' the pattern in the melody as they do.
- Play a piece of music or sing a song that your learners know well. Have them clap or stamp out the beat as they do so. Choose another piece with a slower or faster beat. Ask them to talk about the differences between the two beats.

## Linking rhythmic patterns to shape patterns

- Ask learners to find ways to represent their clapping and stamping patterns using different shapes or colours. For example they can show the pattern:

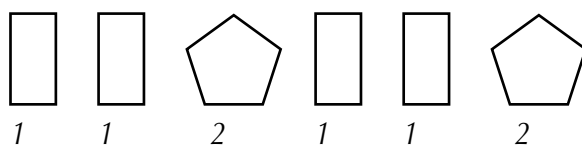
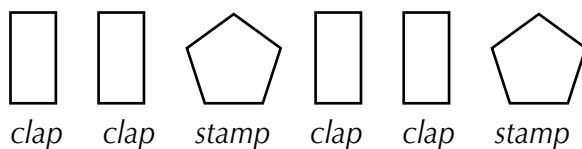

or stamp, stamp, clap, clap, clap like this:

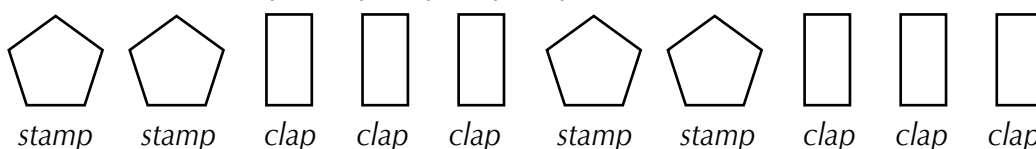

## Grade 2: Patterns, functions and algebra

Let learners take turns, where one learner makes up a clapping pattern and the rest of the group has to copy the pattern as they hear it, using plastic shapes or by drawing the shapes.

### Patterns in shape and number

In shape and number related patterns, a growing pattern shows a change in the number of elements of a pattern. The change can be either an increase or a decrease.

For example, in the case of these squares, there is an increase in the number of shaded squares in each column:

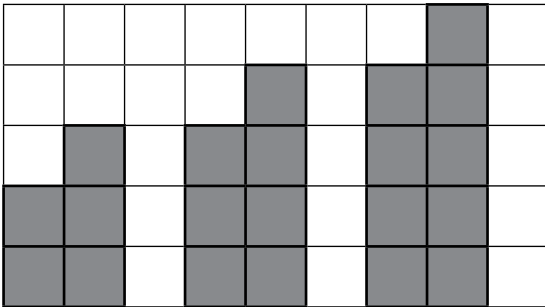

Here, there is a decrease in the number of shaded squares:

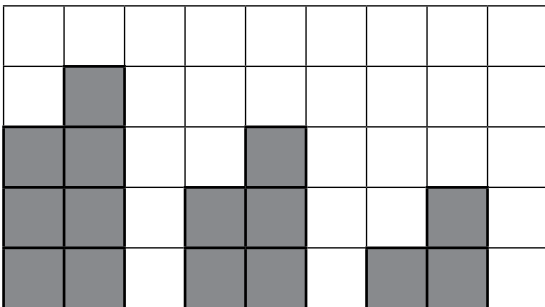

Give learners grid paper to design their own examples of growing patterns that show both increases and decreases. They can use dots, crosses or other symbols.

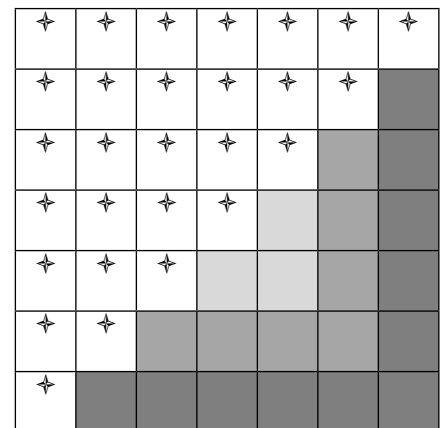
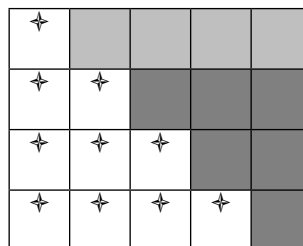

Growing patterns can also mean an increase or decrease in the size of the elements of the pattern.

An increase in the size of the elements:



A decrease in the size of the elements:



Let learners draw examples to show both of these types.

### Rotational patterns

Using shapes or drawings, show learners some examples of rotating patterns, where the object turns a full circle from its starting position to its end position. This is an informal introduction to transformations that learners look at more closely in Grade 4.



Talk about the patterns and how the shape moves each time. Give each learner a set of triangles of the same size to make their own rotational patterns.

They should try to describe the direction of the turn each time. They can use the point or apex of the triangle as their point of reference. Follow up with written activities, where learners have to draw the next or missing turn of the shape in the sequence, or choose which one goes next.

For example, draw the two shapes that come next in the pattern:



Which hand goes next? Tick (✓) the correct one:

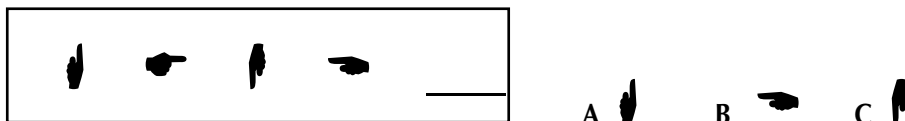

### Drawing line patterns

Begin a pattern like this on the board:



Give learners turns to come to the board and continue the pattern. Let others choose ways to describe the pattern in their own words. For example: curve, curve, line; curve, curve, line; curve, curve, line; ...

*Hoop, hoop, line; hoop, hoop, line; hoop, hoop, line, ...*

Adapted from Marilyn Burns, *About Teaching Mathematics*, A Maths solutions Publication

### Bead patterns

Give learners more opportunities to copy and create their own patterns using beads or similar threading materials. They may form their patterns by repeating colours, shapes, sizes or a combination of repeating elements. For example:

#### Repeating patterns

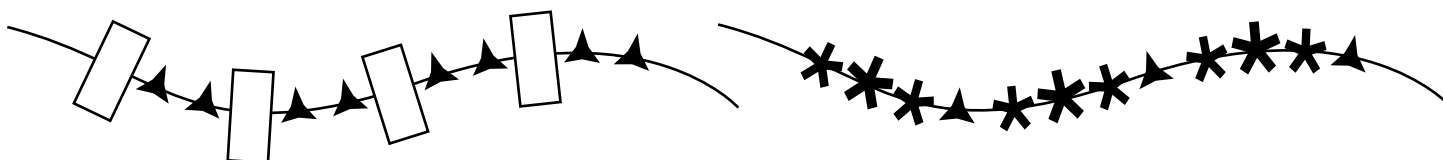



## Grade 2: Patterns, functions and algebra

### A growing pattern



### A growing and shrinking pattern



Allow time for learners to discuss and compare the patterns they make. They should explain how the pattern 'works', what elements it is made up of and how the pattern repeats, grows or changes. Encourage them to use words like: starts again, over and over, one more time, etc. If they are using beads of identifiable shapes, encourage them to name the shapes using both descriptive and mathematical language.

### Group challenge

Give each group a collection of beads of different colours and sizes and ask them to use up as many of the beads as they can to make the longest possible pattern. The same pattern must repeat itself over and over at least 4 times. Groups can then compare their patterns and count how many beads they used in total.

### Using shapes to build patterns

Give out paper or plastic shapes that learners can use to design their own patterns. Always encourage them to describe the different shapes and patterns using both informal and more precise mathematical vocabulary.

For example:

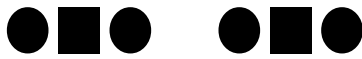

Our 2 shapes repeat over and over again. Our pattern is only made with 2 shapes, squares and triangles



We used 3 shapes in our pattern; circles, squares and triangles.



Also encourage them to use 'position' vocabulary like first, second, last, next, the one before, after and in between to describe their different patterns.

### Representing the same pattern in different ways

Show learners different ways to describe the same pattern using letters, colour names and rhythmic names. vvvv

For example:

√	▲	√	√	▲	√
a	b	a	a	b	a
√	▲	√	√	▲	√
grey	black	grey	grey	black	grey
√	▲	√	√	▲	√
clap	stamp	clap	clap	stamp	clap

### Growing patterns and number relationships

Design a worksheet with examples of patterns that 'grow' in different ways.

#### Increasing patterns

For example:



The number of flowers increases by 2 starting with 1, producing a sequence of odd numbers.



The number of flowers increases by 2 starting with 2, producing a sequence of even numbers.



This is a doubling pattern starting with 1.



This is a halving pattern starting with 8.

To help learners uncover the rules for themselves, let them start by counting the number of flowers in each group of the pattern. Ask questions like, "How many flowers in the first group, the second, the third...?" Now have them write the numbers under each group and then see if they can explain each rule, based on the number patterns that they see.



Have them then predict how many flowers will be in the next group or, for the last example, in the group that comes before the first one shown.

From here they can extend the pattern further by writing out the number pattern, without drawing more flowers:

1; 3; 5; 7; 9; 11; 13; 15; 17; ...

2; 4; 6; 8; 10; 12; 14; 16; 18; ...

1; 2; 4; 8; 16; 32; 64; ...

## Grade 2: Patterns, functions and algebra

### Decreasing patterns

Also give them similar examples of images where the number patterns show change in a decreasing order. For example:

Pattern A:

□□□□□□□ □□□□□ □□□ □

*This pattern begins with 7 and decreases by 2 each time – odd number sequence.*

Pattern B:

□□□□□□□□ □□□□□□ □□□□ □□

*This pattern begins with 8 and decreases by 2 each time – even number sequence.*

Pattern C:

□□□□□□□□□□□□ □□□□□□ □□□

*This is a halving pattern.*

Encourage learners to count the number of objects in each group, and then write the numbers underneath to see what the corresponding number patterns are. This will help them to decode the patterns.

Ask them to say how many rectangles will come one or two places before the first group shown. They can also extend each pattern, this time by writing the numbers only rather than drawing the pictures.

If you extend the number patterns for Pattern A, B and C above, you will get:

13; 11; 9; 7; 5; 3; 1.

16; 14; 12; 10; 8; 6; 4; 2.

48; 24; 12; 6; 3.

Now let learners draw, or use counters or objects, to make their own increasing or decreasing patterns. Encourage them to talk about the different patterns. They should try to make and explain predictions about how many objects come before or next in a sequence. In this way you will help them to develop the vocabulary they need to describe the patterns using the numbers in each 'group' and their positions in the sequence.

### More about position

- Talk about an example like this where each part of the pattern is numbered according to its position in the sequence.

★	★★	★★★	★★★★
1 star	2 stars	3 stars	4 stars
Position 1	Position 2	Position 3	Position 4

Here the number of shapes and their position in the sequence is the same. There is 1 star in position 1; 2 in position 2; 3 in position 3; 4 in position 4 and so on.

## Grade 2: Patterns, functions and algebra

Here, the position number is one less than the number of elements in the pattern.

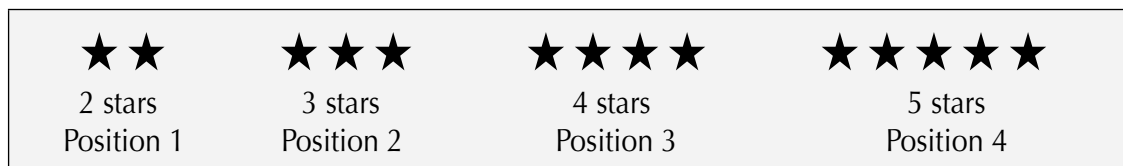

Ask questions that help learners generalise the rule for a pattern like this.  
For example:

“So for 7 stars, what will the position number be? For 34 stars what will the position number be? And for 199 stars?”

They should be able to tell you that the position number will always be one less than the number of stars in each group, because the pattern starts with 2 stars, not 1.

Then turn the question around by asking: “So how many stars do you need for position number 33, number 189?”

They should be able to tell you that they will always need one star more than the position number.

Give learners practice making up their own patterns by drawing shapes or pictures or using counters or other concrete apparatus. They should show examples where the position number is both the same as the number of elements in the pattern or more or less than the number of elements. Make time for them to discuss and compare their patterns. Ask questions that help them to predict the number of elements that come before and after and to generalise rules for the different patterns they create.

In my pattern, there are 3 triangles in Number 1, 5 in Number 2 and 7 in Number 3.

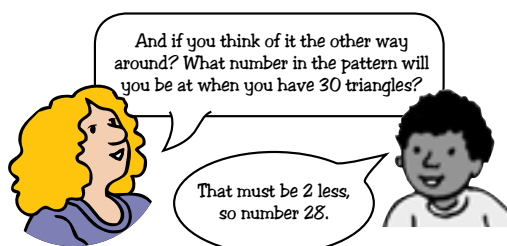
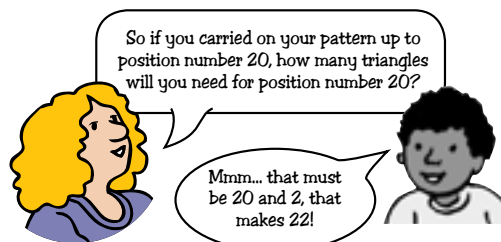
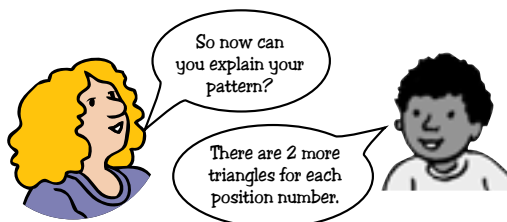
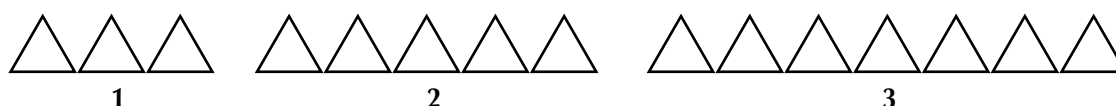

### Skills and knowledge

#### The learner:

- Copies and extends simple patterns using physical objects and drawings.
- Copies and extends simple number sequences to at least 200.
- Creates own patterns.
- Describes observed patterns.

### Suggested activities

#### Introducing number patterns

For young learners to understand our number system, they need to learn about both how we put numbers in order (their ordinal value) and the value of each number (each number's "how muchness" or cardinal value). The way we sequence numbers, how we group them in tens and in multiples of tens, and identifying which digits repeat themselves in a counting cycle, can best be learned and understood by looking for 'patterns' in the structure of the numbers. Work with number patterns should not happen in isolation, but should be integrated with other number work where learners sequence, order and write numbers, group them in different ways and do number calculations. Training learners to observe and use patterns as they work will help them to develop a deeper number sense and confidence in manipulating numbers.

From Grade 2 learners are expected to know, read and write number symbols from 1 to 200.

But even in Grade 1, from the time they begin to work with 2-digit numbers, learners also begin to explore place value relationships and patterns. Learners need to:

- know the order in which we write and say the numbers;
- develop an understanding of the values of the numbers;
- recognise patterns in the number sequences;
- be able to compare smaller or bigger numbers, in a counting sequence, or as part of a group of numbers.

#### Kinds of number patterns

Just as for shape patterns, there are different kinds of number patterns that either repeat or change (grow) from bigger to smaller and from smaller to bigger. It is important that you expose your learners to all of these kinds of patterns. As they become more numerate, they will be able to explore patterns within an extended number range of 1 to 200.

Here are the common kinds of number patterns we want learners to explore.

#### Repeating patterns

21 22 23    21 22 23    21 22 23 ....

#### Growing patterns

131; 132; 133; 134 ; ...    *The numbers increase by 1 each time.*

122; 124; 126; 128; ...    *The numbers increase by 2 each time.*

199; 198; 197; 196; ...    *This is also a growing pattern, but the numbers decrease in size.*

3; 6; 12; 24; 32; ...    *This is a growing pattern that uses doubling.*

160; 80; 40; 20; 10; 5 ...    *This is a growing pattern that uses halving*

## Place value patterns

In Grade 1 learners begin to look for place value patterns in 2-digit numbers.

11 21 31 41 51 61 71 81 91

Once they are in Grade 2, learners need to know how to sequence and order numbers up to 200 and do calculations and comparisons with numbers up to 99. Using patterns can help them with all of these processes.

In this example, Luna is trying to write the numbers from 110 to 190 from memory. She gets stuck at 160. But then she remembers the pattern!

She knows the ones digit is always 0 and the hundreds digit is always 1. Looking back to where she started, she sees a pattern: the 1s digits and the 100s digits remain the same, but the 10s digit increases by 1 each time. This helps her to get 'unstuck' and to finish the sequence of counting in 10s up to 190.

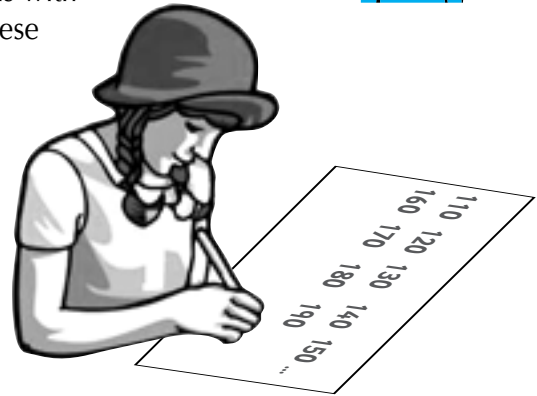

The last number stays the same but the first numbers go from 1 to 9.

Yes the 1s stay the same and the 10s get bigger.

As learners learn to count forwards and backwards from 1 to 100, help them to see that there is both a growing pattern in the 10s digits and a cyclical repeating pattern in the 1s digits.

**121; 122; 123; 124; 125; 126; 127; 128; 129; 130;  
131; 132; 133; 134; 135; 136; 137; 138; 139; 140**

Encourage learners to make this discovery on their own by answering questions about the different digits and the patterns they see.

Let's count in 10s from 10 to 200. Now let's write the numbers down like this. Then we'll look to see what patterns we can find.

In the first row up to 100, each number has 2 digits, one for 10s and one for 1s. The 10s get bigger by 1 each time!

In the second row, the middle number keeps changing. The others stay the same.

And why is that?

Because that's the 10s digit and we're counting in 10s.

Give more examples where they have to think about the patterns in each number and the values of the digits in a given counting sequence.

10	20	30	40	50	60	70	80	90	100
110	120	130	140	150	160	170	180	190	200

## Number grid patterns

Give learners practice looking for place value patterns on their number grids. Use the numbers 1 to 100 and 101 to 200. Let them investigate which digits change and which stay the same as they count along the rows and down the rows, always making time for them to explain the patterns they see.

First look back to the suggestions for activities in Grade 1 and make sure learners can do these patterns, building up from 1 to 100 and then moving on from 101 to 200.



## Grade 2: Patterns, functions and algebra

### Using blank number grids

Start off by using blank number boards to identify patterns with the learners.

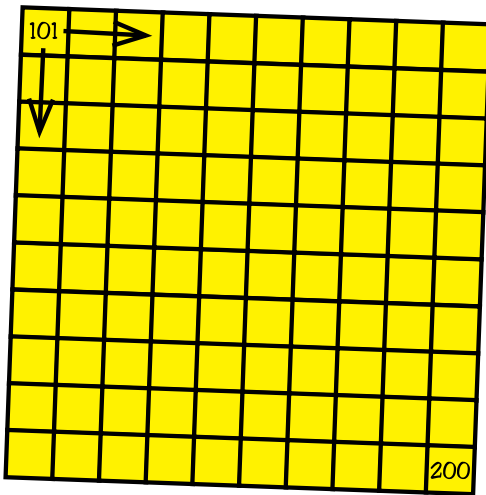

Count the blocks in the first two rows going across. Write in the numbers as you count. Carry on until you get to 200. Check with your friends to see you have the right numbers. So what patterns do you notice when you go across the rows? What patterns do you see going down the rows?



The last number in each row always ends in 0. The middle numbers change in each of the next rows. The 1s always go up from 1 to 9 and then end with 0. The first number only changes when you get to the last block ... that's 200.



Using 'filled out' number boards from 101 to 200

Begin by having learners read and point to the numbers as they say them.

101	102	103	104	105	106	107	108	109	110
111	112	113	114	115	116	117	118	119	120
121	122	123	124	125	126	127	128	129	130
131	132	133	134	135	136	137	138	139	140
141	142	143	144	145	146	147	148	149	150
151	152	153	154	155	156	157	158	159	160
161	162	163	164	165	166	167	168	169	170
171	172	173	174	175	176	177	178	179	180
181	182	183	184	185	186	187	188	189	190
191	192	193	194	195	196	197	198	199	200
191	92	93	94	95	96	97	98	99	200

Ask guiding questions to reinforce what learners have found from working with the blank boards, to draw their attention to the different grouping and counting patterns and to help them understand why these patterns occur.

Count how many numbers there are in each row? Why do you think we put 10 numbers in each row?



Look across the board. What patterns do you see in the numbers? Look down the board. What patterns do you see in the numbers?

Learners should explain which digits and values stay the same and which change when they read the numbers across the rows.

181	182	183	184	185	186	187	188	189	190
191	192	193	194	195	196	197	198	199	200

and down the rows....

101	102
111	112
121	122
131	132
141	142
151	152
161	162
171	172
181	182
191	192

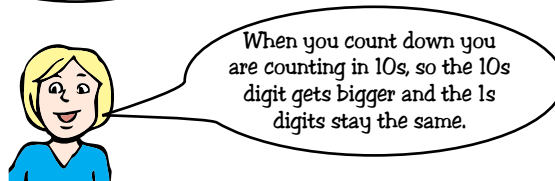
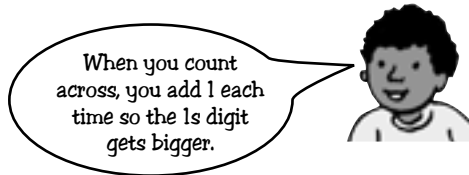

Ask learners to draw the next row of numbers or the next column of numbers, without looking back to their number boards, but by following the pattern of the first two rows and columns shown.

### Addition and subtraction patterns

Design work cards like these for learners to complete as mental maths activities, which they can do by following the patterns they observe.

For the first two work cards they should be able to say how the value of the 1s digit increases by 1, while the value of 10s digit remains the same, except for when they have to add 10. For the next two work cards they should notice how the value of both digits decreases by 1 each time and follow the pattern to find quick answers.

$40 + 1 =$
$40 + 2 =$
$40 + 3 =$
$40 + 4 =$
$40 + 5 =$
$40 + 6 =$
$40 + 7 =$
$40 + 8 =$
$40 + 9 =$
$40 + 10 =$

$50 + 1 =$
$50 + 2 =$
$50 + 3 =$
$50 + 4 =$
$50 + 5 =$
$50 + 6 =$
$50 + 7 =$
$50 + 8 =$
$50 + 9 =$
$50 + 10 =$

$40 - 1 =$
$40 - 2 =$
$40 - 3 =$
$40 - 4 =$
$40 - 5 =$
$40 - 6 =$
$40 - 7 =$
$40 - 8 =$
$40 - 9 =$
$40 - 10 =$

$50 - 1 =$
$50 - 2 =$
$50 - 3 =$
$50 - 4 =$
$50 - 5 =$
$50 - 6 =$
$50 - 7 =$
$50 - 8 =$
$50 - 9 =$
$50 - 10 =$

Give other examples where learners have to add or subtract the same number from numbers that increase or decrease by 10, but that are not whole 10s. After working out the first couple of examples, they should notice the pattern and be able to find the rest of the answers quickly.

$41 + 11 = 52$
$51 + 11 = 62$
$61 + 11 = 72$
$71 + 11 = 82$
$81 + 11 = 92$

$41 - 11 = 30$
$51 - 11 = 40$
$61 - 11 = 50$
$71 - 11 = 60$
$81 - 11 = 70$

$12 + 13 = 25$
$12 + 23 = 35$
$12 + 33 = 45$
$12 + 43 = 55$
$12 + 53 = 65$

$98 - 9 = 89$
$88 - 9 = 79$
$78 - 9 = 69$
$68 - 9 = 59$
$58 - 9 = 49$

Make work cards with different examples of activities like these. Work cards are useful because you can adapt the text book activities to meet your own learners' needs. You can also design work of different difficulty levels for learners who are functioning at different

## Grade 2: Patterns, functions and algebra

levels. Learners can also choose whether they need the support of concrete aids to help them complete the work cards, or whether they are able to work mentally. According to the needs of your different learners:

- make the worksheets shorter or longer;
- use bigger or smaller numbers;
- use other patterns.

### Grouping patterns

Skip counting lays the foundation for working with number groups and doing calculations that involve both grouping and sharing (multiplication and division). To build these skills up gradually, give learners opportunities to lay out one given number in different ways, by grouping counters, or on grid paper, drawing dots in equal rows. Then talk about the different patterns they get. Let them start off with small numbers like 10 and build up to bigger numbers.

Ask learners to lay out the counters in equal rows going across or down and then describe the pattern they get.



This kind of investigation will help build learners' understanding of the commutative nature of multiplication ( $5 \times 2 = 2 \times 5$ ). Both arrangements represent the same number, even though the counters in the rows and columns are 'switched around'.

Follow up by writing two multiplication sentences, e.g.  $5 \times 2$  (5 put out 2 times), for the first one and  $2 \times 5$  (2 put out 5 times), for the second one. Talk about the difference in meaning, even though the answer is the same in each case.

Learners can then repeat this activity for larger numbers. Give them examples of numbers that have several factor pairs that then produce a variety of possible arrangements using the same number of counters, e.g. 12; 24; 36; 48.

Make time for them to discuss and share their different representations, and then ask them to say which multiplication sentence matches their arrangements.

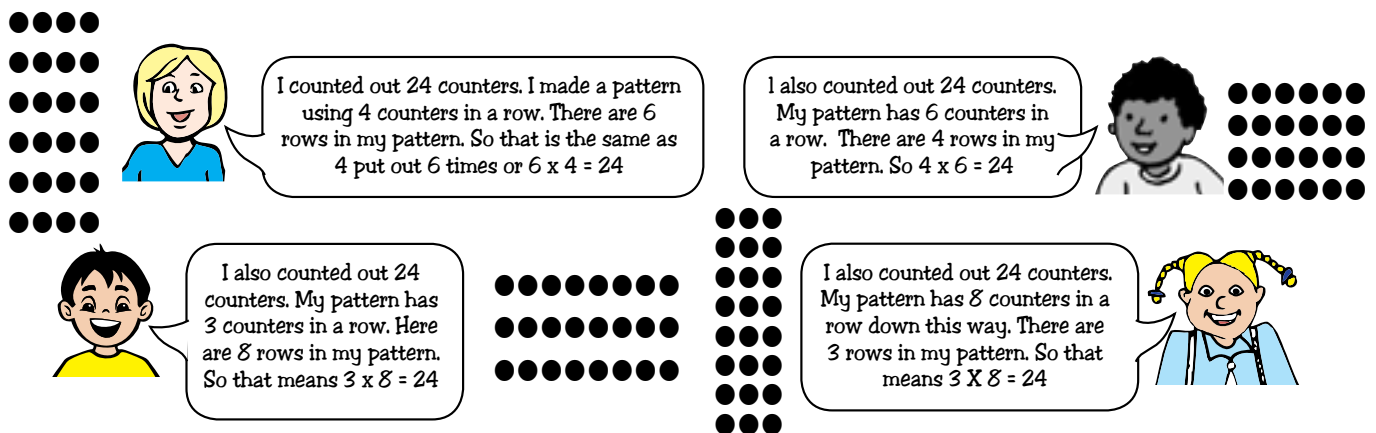

### Skip counting on the number board

By Grade 2 learners are expected to count on (skip count) in groups of 2s, 5s and 10s.

They can use the number board to help them do this and then explore the patterns they get for the different groups of numbers (multiples).

You will need enough number boards so that learners can use them for counting on in different groups and then for shading the numbers they counted.

## Grade 2: Patterns, functions and algebra

Beginning with the 10s pattern, their boards will look like this:

1	2	3	4	5	6	7	8	9	10
11	12	13	14	15	16	17	18	19	20
21	22	23	24	25	26	27	28	29	30
31	32	33	34	35	36	37	38	39	40
41	42	43	44	45	46	47	48	49	50
51	52	53	54	55	56	57	58	59	50
61	62	63	64	65	66	67	68	69	70
71	72	73	74	75	76	77	78	79	80
81	82	83	84	85	86	87	88	89	90
91	92	93	94	95	96	97	98	99	100

101	102	103	104	105	106	107	108	109	110
111	112	113	114	115	116	117	118	119	120
121	122	123	124	125	126	127	128	129	130
131	132	133	134	135	136	137	138	139	140
141	142	143	144	145	146	147	148	149	150
151	152	153	154	155	156	157	158	159	160
161	162	163	164	165	166	167	168	169	170
171	172	173	174	175	176	177	178	179	180
181	182	183	184	185	186	187	188	189	190
191	192	193	194	195	196	197	198	199	200

For the 5s pattern, their boards will look like this:

1	2	3	4	5	6	7	8	9	10
11	12	13	14	15	16	17	18	19	20
21	22	23	24	25	26	27	28	29	30
31	32	33	34	35	36	37	38	39	40
41	42	43	44	45	46	47	48	49	50
51	52	53	54	55	56	57	58	59	60
61	62	63	64	65	66	67	68	69	70
71	72	73	74	75	76	77	78	79	80
81	82	83	84	85	86	87	88	89	90
91	92	93	94	95	96	97	98	99	100

101	102	103	104	105	106	107	108	109	110
111	112	113	114	115	116	117	118	119	120
121	122	123	124	125	126	127	128	129	130
131	132	133	134	135	136	137	138	139	140
141	142	143	144	145	146	147	148	149	150
151	152	153	154	155	156	157	158	159	160
161	162	163	164	165	166	167	168	169	170
171	172	173	174	175	176	177	178	179	180
181	182	183	184	185	186	187	188	189	190
191	192	193	194	195	196	197	198	199	200

For the 2s pattern:

1	2	3	4	5	6	7	8	9	10
11	12	13	14	15	16	17	18	19	20
21	22	23	24	25	26	27	28	29	30
31	32	33	34	35	36	37	38	39	40
41	42	43	44	45	46	47	48	49	50
51	52	53	54	55	56	57	58	59	50
61	62	63	64	65	66	67	68	69	70
71	72	73	74	75	76	77	78	79	80
81	82	83	84	85	86	87	88	89	90
91	92	93	94	95	96	97	98	99	100

101	102	103	104	105	106	107	108	109	110
111	112	113	114	115	116	117	118	119	120
121	122	123	124	125	126	127	128	129	130
131	132	133	134	135	136	137	138	139	140
141	142	143	144	145	146	147	148	149	150
151	152	153	154	155	156	157	158	159	160
161	162	163	164	165	166	167	168	169	170
171	172	173	174	175	176	177	178	179	180
181	182	183	184	185	186	187	188	189	190
191	192	193	194	195	196	197	198	199	200

In each case, ask learners to read the numbers they shaded. Then ask questions that help them to talk about the different patterns, to compare the patterns for different groups, to see which numbers occur in more than one group and to generalise the rules for each pattern to bigger numbers that aren't shown on the boards.

To help them generalise rules for the 2s, 5s and 10s patterns, ask questions like:

"Busi says the number 236 is in the 5s pattern.

Is she correct? How do you know?"

"Mahmud say 560 is in the 5s and the 10s pattern.

Is he correct? How do you know?"

What numbers do the numbers in the 10s pattern end with?  
What numbers do the numbers in the 5s pattern end with?  
Which numbers are both in the 10s pattern and the 5s pattern? (the multiples of 10)



Ask them to say which numbers occur in all 3 patterns. (*the multiples of 10*)  
Ask them if a number like 235 or 238 is in the 2s pattern and to say how they know.

## Grade 2: Patterns, functions and algebra

### Written practice

Once learners have done lots of work with the number boards, and can read and say the numbers in the different patterns, give them written exercises to consolidate what they have learned. Use examples where they have to extend a pattern you start for them, fill in missing numbers left out in a sequence or identify numbers that don't belong in a given pattern sequence.

- a) 110; 120; 130; \_\_\_\_ ; \_\_\_\_ ; \_\_\_\_

*Extending the pattern*

- b) Write all the numbers in the 10s pattern between 120 and 190.

*Writing a pattern sequence for a given range.*

- c) 120; \_\_\_\_; 140; \_\_\_\_; 160; 170; \_\_\_\_; 190

*Finding the missing numbers*

- d) 120; 130; 140; 150; 160; 170; 180; 185; 190; 200

*Circle the number that does not belong.*

- e) Which of these numbers is in the 2s pattern, the 5s pattern and the 10s pattern?

125      132      140      164

*Finding patterns that converge*

- f) Which of these numbers is in the 10s pattern?

134;      450;      655;      789

*Generalising the pattern to larger numbers.*

Give learners lots of practice examples like these that cover the 2s, 5s and 10s patterns.

## Vocabulary

### Grade 1, 2 and 3:

Repeating pattern; language to describe patterns, e.g. position words - right, left, first, second, last, next, the one before, the one after; shape and colour words; increase or grow, decrease or shrink; doubling; halving; rows and columns.

## Resources

Pictures of patterns in nature, in drawings, clothes, paving, houses etc; pattern posters if possible; musical instruments to make rhythm patterns; cut-out shapes for making patterns; beads, seeds, threading string etc; potato prints or stencils; paints; glue and scissors; coloured paper; counters; number dot cards; number cards; grid paper; number boards and blank number boards; weather charts, timetables, life cycle charts etc; wrapping paper or wall paper





# Grade 2: Shape and Space (Geometry)

The learner will be able to describe and represent characteristics and relationships between two-dimensional shapes and three-dimensional objects in a variety of orientations and positions.

## Skills and knowledge

### The learner:

- Recognises, identifies and names two-dimensional shapes and three-dimensional objects in the school environment and in pictures including:
  - a) boxes (prisms), balls (spheres) and cylinders;
  - b) triangles, squares and rectangles;
  - c) circles.
- Describes, sorts and compares two-dimensional shapes and three-dimensional objects in pictures and in the environment according to:
  - a) size;
  - b) objects that roll or slide;
  - c) shapes that have straight or round edges.
- Observes and builds given two-dimensional shapes and three-dimensional objects using concrete materials (e.g. building blocks, construction sets and cut-out two-dimensional shapes).

The vocabulary that learners need to understand and use for these skills is listed at the end of the suggested activities. You will find it helpful to make flash cards with key vocabulary words to support the teaching and learning process. A list of the resources you will need for the activities is also provided.

## Suggested activities

### 1. Working with 3-D objects

#### Straight and curved

Learners work in groups. Give each group two plastic circular hoops or frames and a pile of 3-D blocks: some with only straight sides, some with only curved sides and some with both straight and curved sides. They should place the hoops so that they overlap and sort the groups into three sets, A, B and C; A for objects with straight sides, B which is the overlapping space, for objects with both straight and curved sides and C for objects with only curved sides.

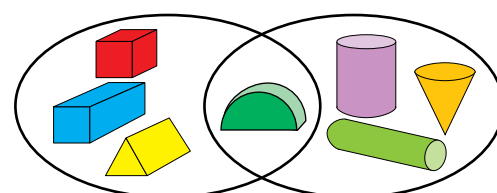

A: Straight sides    B: Both    C: Curved

#### Sliding and rolling

Using the same 3-D blocks that learners sorted above, ask them to first predict and then test to see which of them roll and which of them slide. Talk about why this is so, encouraging them to use words like smooth, straight, round, edges, surfaces and corners.

Once they have done this, give them a worksheet that you have prepared with drawings of an assortment of objects, like balls, boxes, cylinders, wheels and have them sort them into two groups and write the words 'slide' or 'roll' next to each object. Or they could merely draw a circle around the objects that roll and a square around the ones that slide.

Ask learners to draw two more examples of objects that roll and objects that slide.



## 2. Moving from 3-D to 2-D

### Investigating faces

Collect a variety of empty food and household cartons that learners can investigate and break up. They should start by examining the boxes and looking at them from all their different sides, describing what shapes they see. Introduce the term 'face' again, as the name we give to the flat surfaces of a 3-D object.

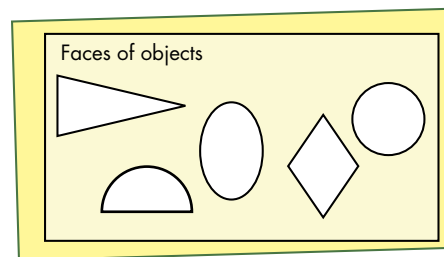

As most of the boxes you collect will be made up from both squares and rectangles, now is a good time to talk about the differences between the two. It is important that learners see squares as belonging to the class of shapes we call rectangles.

Learners should understand that squares are a special kind of rectangles with **both** pairs of opposite sides the same length.

Learners can then undo their boxes and check to see what they look like when flattened out and count and name the different faces.

They can then see how their boxes fold back together again and check where all the different faces they counted appear.

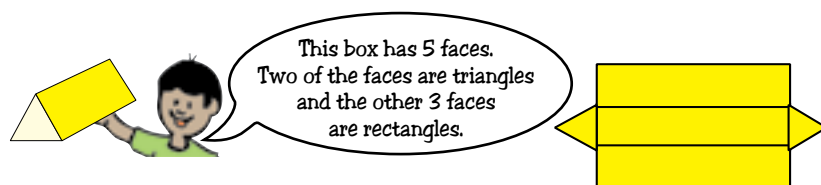

### Tracing around faces

Learners work in groups. Give each group a selection of prisms and cylinders and a large sheet of paper. Use any of the different blocks from your sets of blocks to again point out what we mean by the terms 'faces', 'edges' and 'corners'.

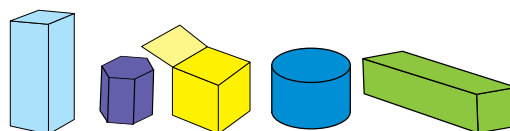

Use a cylinder to demonstrate that objects with curved surfaces have curved edges and no corners. Talk more about cylinders and ask learners to say how else they differ from the rest of the blocks in their sets. They should be able to explain that all the faces of a cylinder are curved; that there is only one side face that 'wraps around' itself, and that the bottom and top faces are circles (if the cylinder is closed and solid).

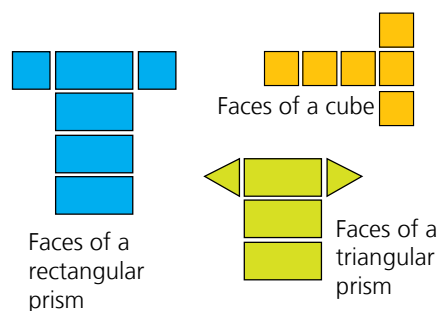

Now let each learner choose a different shaped block from the set on their table, and trace around all its faces. Help them to label each shape when they are finished.



### Naming 2-D shapes

Choose one example of each kind of block that learners traced around to put up on the board. Have a whole class discussion where learners discuss which shapes make up each block, using the correct mathematical names. They can copy each of the different examples in their books and label each of the faces with their correct name (circles, triangles, rectangles or squares).

## Grade 2: Shape and Space (Geometry)

As they will not have been able to trace around the sides of the cylinder, use a cardboard model of a cylinder to show how its sides are formed from a rectangle folded and joined to form one continuous curve.

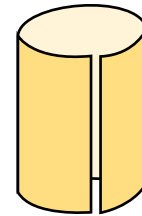

See Resources, p373, for cards you can copy for your learners.

### Sorting prisms

Give each group of learners an assortment of three different shaped prisms that includes cubes, rectangular, and triangular prisms. Do not introduce the formal terms yet. Rather hold up an example of each of the three objects in turn. Let learners tell you all they can about each kind of object. Let volunteer learners write all their ideas up on a class chart. Now ask learners to work in their groups to sort their objects into three groups. Let groups discuss and check each other's sorted groups. Next ask them to use their own informal language to tell you in what way the three different groups of blocks are the same.

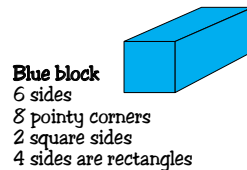

**Blue block**  
6 sides  
8 pointy corners  
2 square sides  
4 sides are rectangles

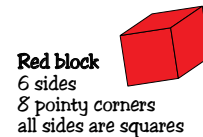

**Red block**  
6 sides  
8 pointy corners  
all sides are squares

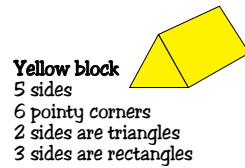

**Yellow block**  
5 sides  
6 pointy corners  
2 sides are triangles  
3 sides are rectangles

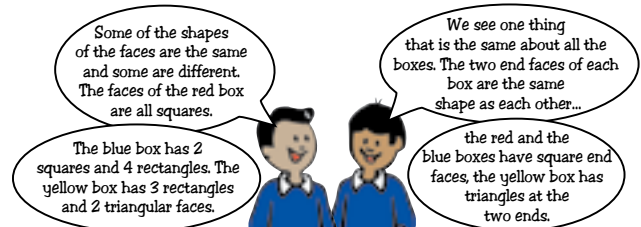

Then introduce the term 'prism'.

Mathematicians call all boxes that have two 'end' faces that are the same shape, prisms. These two identical shapes must be joined by shapes that have straight edges.

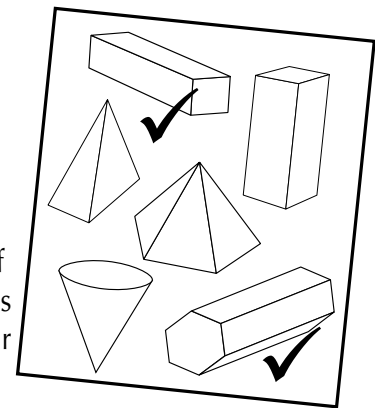

To reinforce this understanding, prepare a worksheet that has examples of both prisms and non-prisms. Learners should mark which ones are prisms and which ones are not. Have a whole class discussion to summarise their findings. Support struggling learners by letting them check their ideas on examples of concrete objects as you ask guiding questions.

### Shape riddles

Make up shape riddles based on the different kinds of prisms and cylinders they've been working with. For example:

- I have two circles at the ends and one curved face. What am I? (a cylinder)
- I have five faces and three of them are rectangles and the opposite ends are triangles. What am I? (a triangular prism)
- I have six square faces that look the same whichever way you turn me. What am I? (a cube)

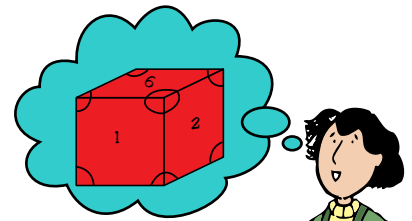

### Guess the shape

Arrange a collection of 3-D blocks or cartons on the table. They should include square, rectangular and triangular prisms, spheres (balls) and different sized cylinders. For each object prepare a card with the name of the object written clearly.

Put a cloth over the objects so that they are hidden from the learners' view. Give learners from each group turns to be blindfolded and choose any of the objects from under the cloth. They must then describe the object they choose in as much detail as they can. Ask questions to guide them. For example: "How many faces does it have? What shapes are they? Which faces are the same? Does your object slide or roll? Do you know the name of the object?"

Once the learner has said all he/she can about the object, take off the blindfold and let the learner see if he/she described and named the object accurately. The whole class can then help you decide which of the labels to use to name the object. Paste the label on the object or put it against the object on a display table. Give more learners the chance to be blindfolded and choose, describe and name the rest of the objects that are covered.

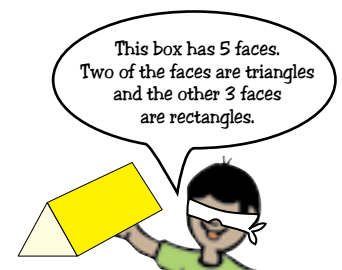

### Miming 3-D objects

Tell the learners that you are going to describe a particular object without saying anything. They must be quiet and watch your movements. Pretend that you have a large cube in your hands. With hands outstretched, feel around the edges. Show the front, back and sides. Point out with the movements you make all its edges, faces and corners. Then have the learners say what shape you have been miming. Let them explain how you showed the faces, edges and corners.

Learners can then repeat the same activity. In their groups, they can mime out the features of different 3-D objects and 2-D shapes in the same way.

### Labelling 3-D objects

Once you have completed several investigations like these, you can then place more emphasis on getting learners to learn to say and write the mathematical names and terms we give to these shapes and their properties.

To help them, prepare cards for the wall or board that have pictures of each object with their labels written clearly underneath. Learners can practise reading the names and writing them correctly. Ask guiding questions to help learners work out why the triangular prism and the square prism are so called.

Ask them to say what they think a rectangular prism looks like. Add drawings of different rectangular prisms to your display.

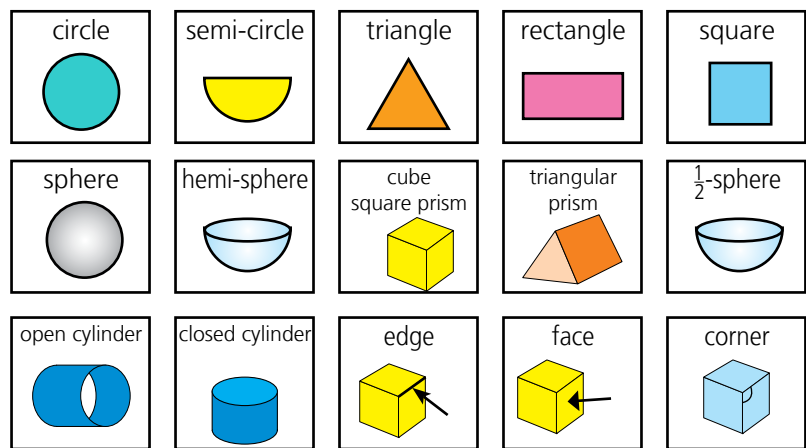

**Include these names and drawings in your set.**

## 3. Working with 2-D shapes

### Straight and curved

On the board, draw and colour with chalk three examples of closed 2-D shapes – one with only straight sides, one with only curved sides and one with both straight and curved sides.

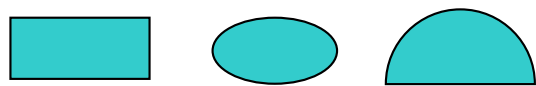

Now ask learners to draw similar shapes following instructions you give them. For example, ask them to draw:

- a closed shape with three straight sides;
- a curly closed shaped with one straight edge.

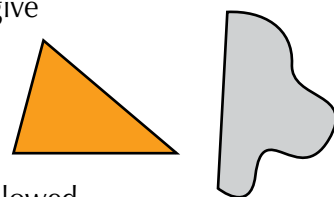

Learners can then check each other's drawings to see if they have followed your instructions correctly. Use some of the examples they have drawn to make a chart for the classroom wall with the following headings: closed shapes with straight sides; closed shapes with curved sides; closed shapes with curved and straight sides.

## Grade 2: Shape and Space (Geometry)

### Circles, triangles and rectangles

Prepare some worksheets to assess your learners' prior knowledge of circles, triangles and rectangles. For example: "How many circles are there? Colour them blue."

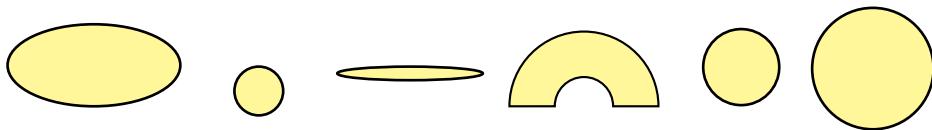

See Resources, p371 for shapes you can cut out and copy for your learners

"Mark the shapes that are not triangles."

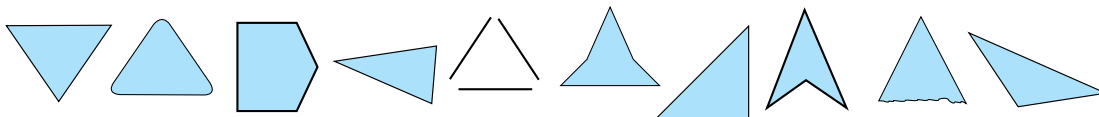

### Counting sides

Prepare activities that help learners practise counting and comparing the number of sides of different polygons (closed shapes with straight sides). Have them say which shape does not belong in the group and why. In this example, they should realise that Shape A does not belong as it is the only shape with five sides..

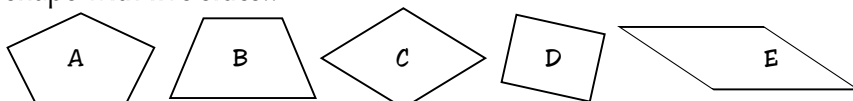

See Resources, p376, for example worksheet you can adapt.

### Investigating rectangles

Make a worksheet like this to give out to each group of learners. Ask them to first count how many sides each shape has (they will find that all of them have 4 sides). Next ask them if this then means that all these four-sided shapes are rectangles. Let them discuss this.

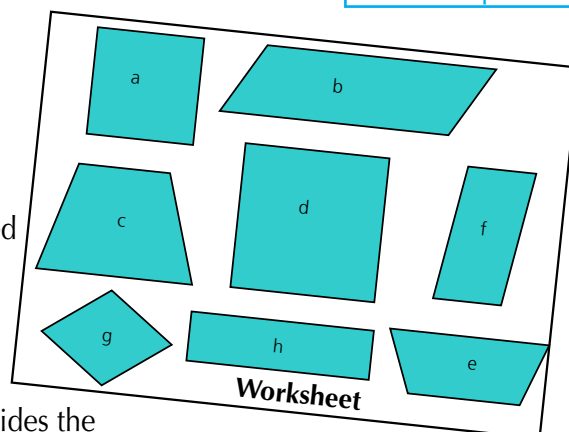

This should lead learners to think back to the definition of a rectangle – a closed shape with four straight sides and four square corners (right angles) and its opposite sides the same length. They can then look again at each shape and decide which of them fit this definition and which do not.

When coming to the square (d), there is likely to be a dispute, where some learners will say it is a square and not a rectangle. This gives you another opportunity to emphasise that a square is in fact a special kind of rectangle where both pairs of opposite sides are the same length.

### Feel the rectangles

Put a collection of different shaped rectangles and squares into a bag. Learners take turns to choose one of them without looking. They must decide, while feeling the shape, whether it is an ordinary rectangle or a rectangle that is a square, with all sides the same length.

I feel four sides but two are shorter than the others so it's an ordinary rectangle not a square.



### Body shapes

Divide the learners into groups of three and ask them to form themselves into different kinds of triangles. They can do this standing up or lying down.



## Grade 2: Shape and Space (Geometry)

Then divide them into groups of four and ask them to form themselves into different kinds of rectangles including squares, for which they will need to find four learners of the same height. Extend the challenge where they have to make other four-sided shapes that are not rectangles, like trapeziums, rhombuses (diamonds) or kites. Show them pictures of these to copy.

Learners can then work in groups of five or six to make five-sided pentagons or six-sided hexagons in the same way. This activity will help them to think about the differences between 2-D shapes in relation to the number of their sides, the length of sides and how many corners they have.

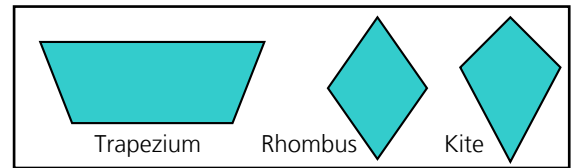

### Categorising 2-D shapes

Show a set of shapes with squares, rectangles of different sizes, triangles of different shapes and sizes as well as trapeziums and rhombuses (diamonds).

Give a pile of shapes to learners to sort. They should each find an example of each kind of shape in the set, draw it, count the sides and the corners and, if they know the name of the shape, write it in as well.

Draw the shape	Count the sides	Count the corners	Name the shape

### Sorting 2-D shapes

Give the learners instructions on how to sort the whole group of shapes in different ways.

For example: "Put all the shapes with straight sides together; all the shapes with curved sides together, including shapes like semi-circles that have one straight and one curved side."

Next they can sort the group with straight sides into sub-groups. For example:

- "Put the shapes with three sides in one group, shapes with four sides in another group and shapes with more than four sides in a third group"

Ask them to sort these further. For example:

- "Sort the four-sided shapes into shapes that are rectangles and shapes that are not rectangles" (at this stage the group of rectangles should include squares).
- "Now find which of the rectangles are squares and put these into their own group."
- "Sort the rest of the four-sided shapes out, putting those that are the same together." They may, for example have rhombuses (diamonds), kites or trapeziums left.
- Next they can sort the shapes with three sides (triangles) into different groups, putting those of the same shape and size together.
- They can then draw a group pictograph to show how many of each kind of shape they have.



## Grade 2: Shape and Space (Geometry)

### Working with geoboards

Give each pair of learners geoboards with elastic bands of different sizes to form different 2-D shapes. First let them experiment on their own to see what shapes they can make using different sized bands. Make time for them to discuss and compare these in their groups and with the whole class.

Next you can draw shapes on the board which they must copy. Once they have had some practice doing this, describe shapes without drawing them, so they have to listen carefully to your instructions and verbal cues. For example:

- "Make a rectangle with two long sides and two short sides or with all sides the same length." (a square)
- "Make the biggest triangle you can, pointing downwards."
- "Make a triangle with all sides the same length, pointing to the left."

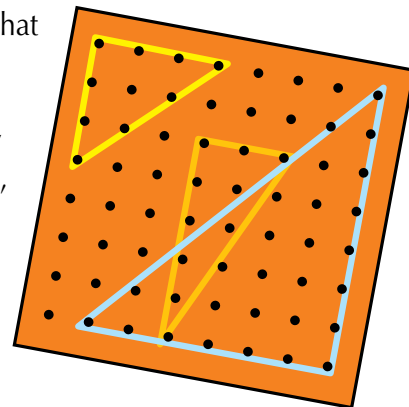

### 4. Drawing 2-D shapes

#### Describing 2-D shapes

Give each group a collection of different 2-D shapes that include different kinds of triangles and rectangles, including squares. You can also include rhombuses (diamonds) in the set.

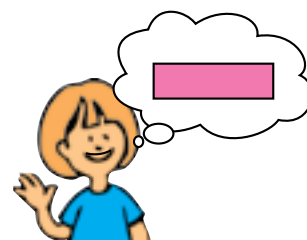

One learner chooses a shape but does not show the rest of the group what it is. He /she describes the properties of the shape to the rest of the group, who must draw the shape being described.

For example: "My shape has four sides and the two opposite sides are the same, but two of the sides are much longer than the other two."

Each learner in the group gets a chance to choose and describe a shape while the rest of the group tries to draw it.

#### Cutting out matching shapes

Give learners different cut-out shapes, scissors and paper and let them practise tracing around each shape and then cutting it out. They can then construct a pictograph that shows how many of each shape they have and also write something down about each of the shapes in their graph.

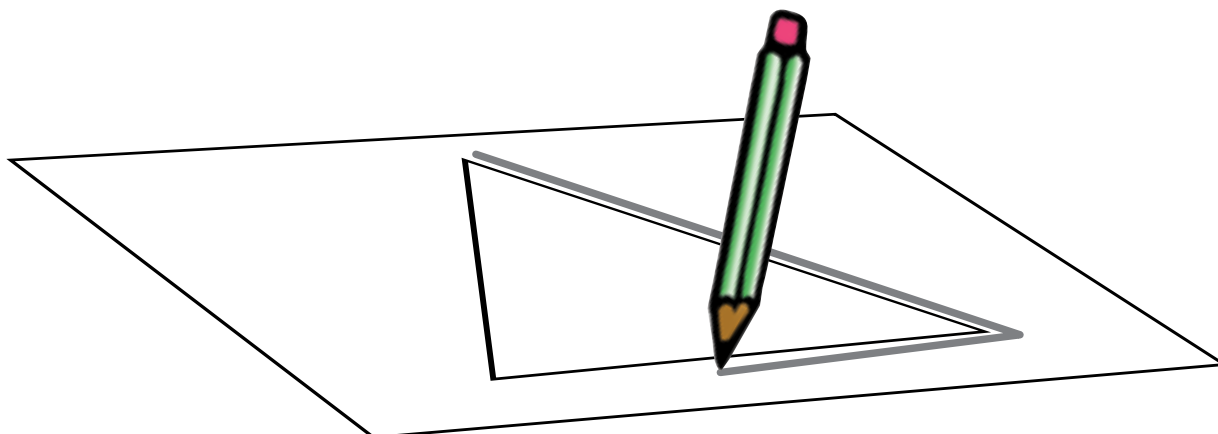

### Drawing rectangles on grid paper

Give out square grid paper and ask learners to draw different sized rectangles and count how many blocks each shape covers.

Then ask them to see if they can draw rectangles that cover the same number of blocks in different ways. This activity builds their understanding of number groups, multiplication and area at the same time.

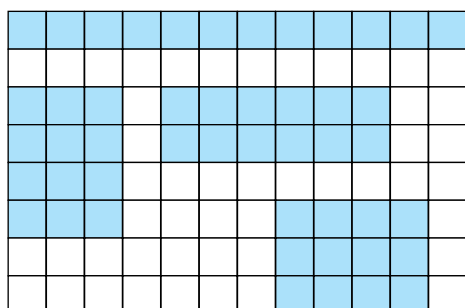

**For example all of these rectangles cover 12 blocks**

### Tracing a design

Show learners an example of a design for a fish net or a wire fence made from joining (tessellating) triangles.

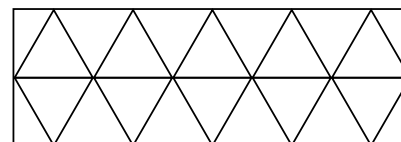

Give each learner a cardboard or plastic triangle to trace around and to make their own net patterns. Challenge them to see how many triangles with joining sides they can fit on a page.

### Mind bending activities

Provide learners with 'mind-bending' tasks like these that encourage them to go beyond what they see at first. For example, draw a pattern like this one and ask them to count how many triangles there are:

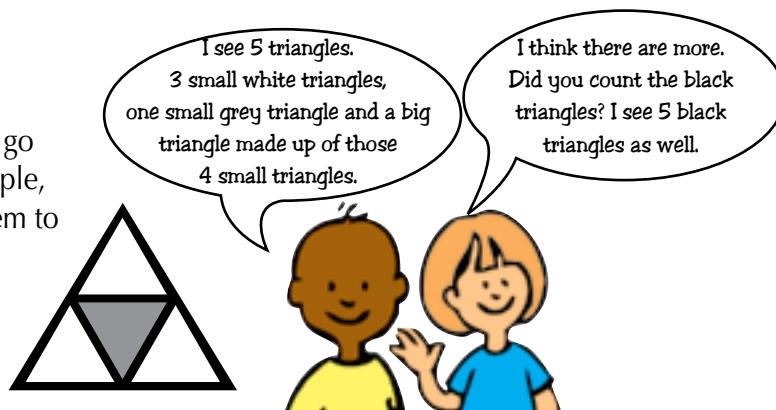

Give learners small sticks like match sticks (preferably without ends) for them to make four adjoining squares that together make one big square.

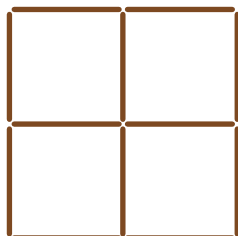

Ask them to count how many squares there are altogether. Now ask them to see how they can take away 4 sticks so that they are left with only 2 squares.

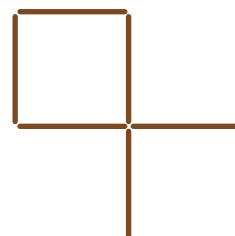

Can they take 2 sticks and leave two squares?

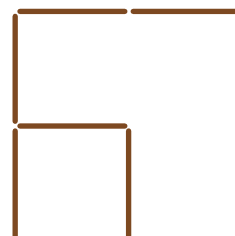

See Resources,, p381, for example worksheet.

## Skills and knowledge

### The learner:

- Recognises symmetry in two-dimensional shapes and three-dimensional objects.

## Suggested activities

Note: We have made the point in Grade 1 that:

Learners must realise that symmetry is different from 'the same as', e.g. two identical wings of a leaf are the same but the right and left parts of the leaf are not the same but symmetrical with reflecting sides.

### Left and right

Repeat songs and rhymes that learners may have learned in Grade R and 1 that help them to show and distinguish their left from their right when they are facing the front and when they turn around.

Play the game 'Simple Simon' where you mime actions that learners have to follow. If they get them wrong, they are out of the game. For example, you say: "Simple Simon says put your right hand up". Learners follow by putting up their right hands and so on. But if you say, "Simple Simon says put your left foot out" and you put your right foot out instead and they copy you, they are out of the game.

Do more preparatory activities where learners have to cross their 'midline'. For example: "Put your right hand on your left knee, your left hand on your right foot."

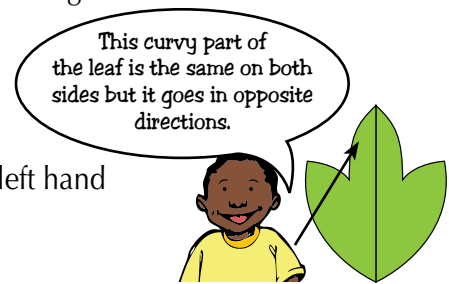

### Body symmetry

Learners should know by now that the left side of the body is symmetrical to the right, but that the top of their bodies is not symmetrical to the bottom and their front is not symmetrical to the back. Ask them questions to consolidate this understanding.

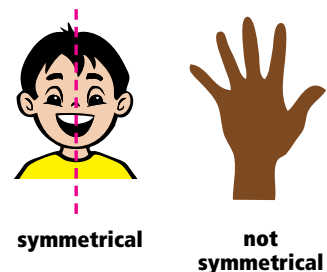

### Drawing lines of symmetry

Make a worksheet with different parts of the body, e.g. a nose, a mouth, a hand. Show them how to draw a dotted line to show when there is symmetry, either going across, or up and down or both. They should mark these on their drawings and also find which examples (like a hand), do not have symmetry in any direction.

### Finding symmetrical and non-symmetrical objects

Ask learners to identify which objects and shapes around the classroom have symmetry and which don't. Give each learner the chance to choose one symmetrical and one asymmetrical object, and to explain their choices to the rest of the class.

Make flashcards with the words 'symmetry' and 'no symmetry'.

Learners can then construct a class pictograph, putting their objects in the right place in the graph.

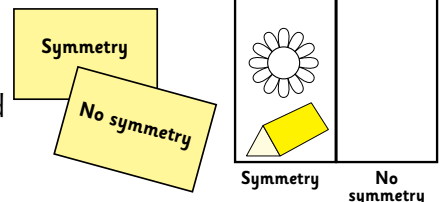

### Symmetry in designs

#### Identifying symmetrical designs

Provide photographs or drawings of Ndebele huts or of pots that have designs on them. Let learners find and discuss examples of symmetry and non-symmetry.

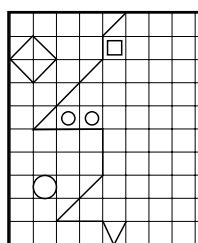

See Resources, p370 and 372, for examples you can use.

## Grade 2: Shape and Space (Geometry)

Provide drawings of half objects and ask learners to draw the other half. Be sure to include examples with horizontal, vertical and diagonal symmetry. Learners can use their mirrors to check their drawings.

Let learners collect leaves of different shapes outside the classroom. The leaves should be flexible so that they can be folded. Learners can investigate symmetry by seeing how they can fold the different leaves in half so that the two parts fit on top of each other. They can also trace around their leaves and draw in the 'fold lines'.

Let learners use small mirrors to investigate symmetry and non-symmetry in pictures from books or in photographs. It is probably best to use simple pictures such as those in books for very young children.

Collect sets of cut-out pictures from magazines and newspapers. Let learners use folding techniques to investigate symmetry and non-symmetry.

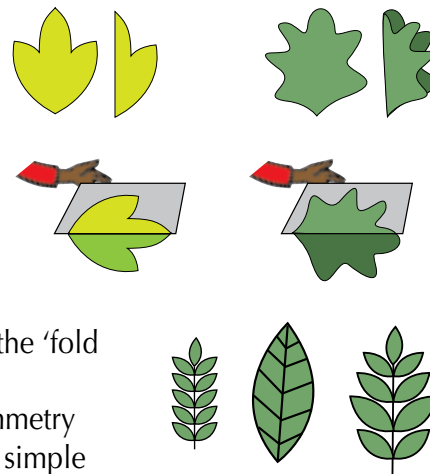

### Using pegboards

Give learners pegboards to make their own symmetrical designs. One learner can use pegs in half the board and their partner should complete their pattern, making sure it is symmetrical. They then swap roles.

*The same activity can be done on squared paper using pencils and crayons*

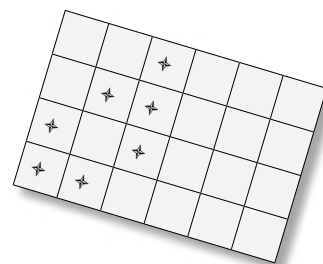

### Shape designs

Draw two patterns on the board, using different shapes. One pattern should be symmetrical and the other asymmetrical. Learners must say which one is which and why. They can then use plastic or cardboard shapes to make examples of their own symmetrical shape patterns and copy these into their books.

Do not focus on the absolute accuracy of the shape they draw, but on whether their patterns convey a sense of symmetry.



### Symmetrical models

Let learners make symmetrical models using different shaped blocks or boxes. Let them start by choosing a middle shape and then working outwards.

Once they have done this, ask them to experiment by building two models, one with an even number of blocks and another with an odd number of blocks and to say where the line of symmetry falls in each one.

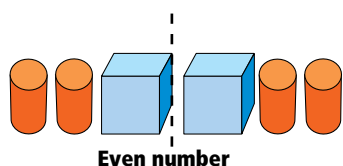

Here the line of symmetry falls in the space between the two cubes

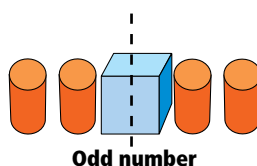

Here the line of symmetry falls down the middle of the centre block

Let them repeat this using more blocks to see if this is always the case. Talk about reasons for this.

## Skills and knowledge

### The learner:

- Observes and builds given two-dimensional shapes and three-dimensional objects using concrete materials (e.g. building blocks, construction sets and cut-out two-dimensional shapes).
- Recognises three-dimensional objects from different positions.

## Suggested activities

### Position and viewpoint

#### Hidden views

Take a familiar object like a suitcase. Cover all but one of its sides and ask learners to see if they can identify the object and explain how they recognised it. Repeat the activity with other objects that are both familiar and less familiar, to make the activity more challenging. Change the faces that you hide each time, to give learners practice identifying objects from all possible views.

#### From where we stand

Use different shaped objects on the table like a cereal box, toilet roll, toy house, pen, slice of cake, etc. Place one of the objects on the table, floor, chair, etc. Ask a few learners to stand on different sides of the object and to describe to the rest of the class what they see. Then let them change sides and describe the same object from a new position around the table. Let them also climb up onto the table and describe what the object looks like from the top.

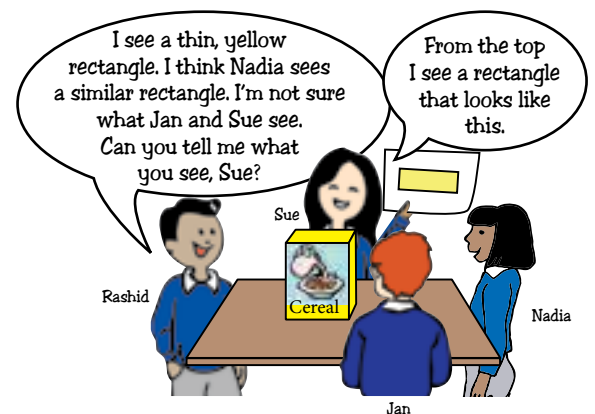

#### From where we sit

Let learners work in groups. Place a box, like a cereal box on each group's table. Let group members sit on different sides of the table. They should describe and draw what they see from where they sit and then visualise, describe and draw what they think they will see if they were to view the box from a different position. Give learners more practice viewing and describing a range of objects from different positions. Make work cards like this one where they have to say what view of the object they see from a particular position.

Peter looks at the toy house from the side. What does he see?



Tick (✓) the correct picture.



#### Block views

Give each group of learners a pile of wooden blocks or multilink cubes that join together to make block buildings. They should start with a simple model made from only three or four blocks.

Ask them to examine the model from the front, the back, the top and the left and right hand sides and to describe to their group members what they see. They should also be able to say what the model looks like from underneath without lifting it off the table.

Prepare a worksheet with drawings of different block models. Ask learners to work

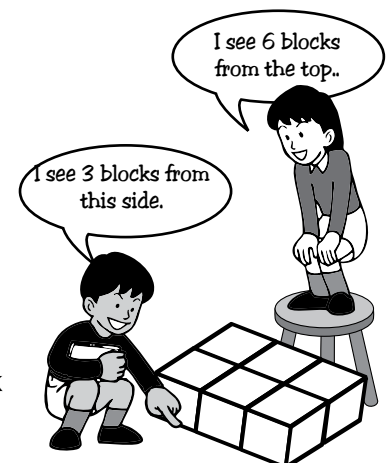



## Grade 2: Shape and Space (Geometry)

out how many blocks they would see if they looked at them from different viewing points.

### More views of objects

Give each group of learners a box and a ball to place in the middle of their table.

Ask them to move around the table and look at the two objects from the front, the back, the sides and the top. They must describe what they see and how the view changes as they move their position.

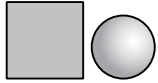
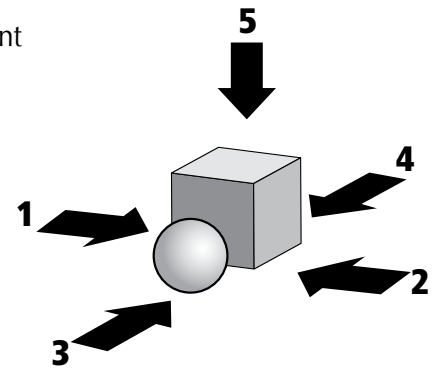

1. The box is to the left of the ball when I stand on this side.

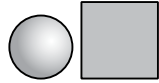

2. But when I stand on the other side, the box is to the right of the ball.



3. The ball is in front of the box when I look at it from the front.



4. But when I look at it from the back, the ball is on the other side and I cannot see it any more.

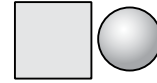

5. When I look at it from the top I see the curve of the ball on the right and the square face of the box on the left.

Repeat the activity with different objects and geometric blocks.

### Interpreting pictures of views

Once learners have had practical experience of moving positions and describing different views, they will be able to interpret pictures of different views and viewing positions more easily.

For example:

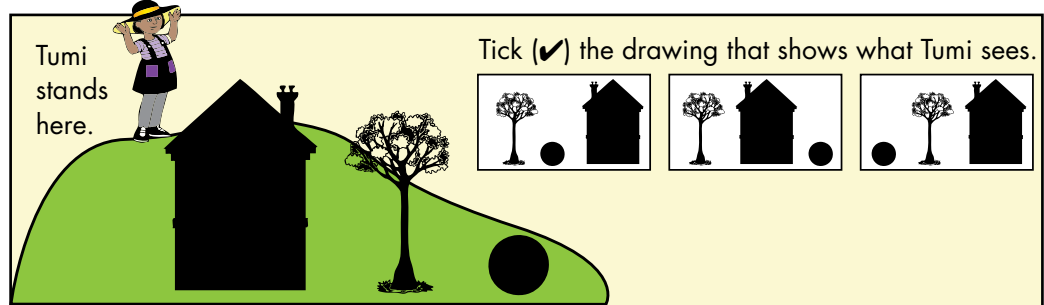

### A toilet roll camera

Let learners use a cylindrical object (e.g. a toilet roll) as an imaginary camera. Let them look at objects from different positions and distances and report on and/or draw what they see. They should realise that the closer they get to an object, the less of it they will see, but the detail will become clearer.

### Taking pictures

If you have a camera or cell phone camera available, you can take photos of the same object from different views. Make copies of these and ask learners to study the photographs, identify what object it is and say what view each one shows.

## 2. Building with 3-D objects

### Observing 3-D buildings in models or pictures

Use models of houses or pictures of models as a talking point to investigate the kinds of shapes used to build them. Try to include examples of traditional African huts that are square, rectangular, cylindrical and dome-shaped.

Talk about the different shapes used for the roof and the base of the buildings. Encourage learners to use both informal and formal ways to describe their similarities and differences. For example:



## Grade 2: Shape and Space (Geometry)

The rondavel is curved like a cylinder at the bottom, and its roof is pointed and also curved – maybe it's a cone!

This Zulu hut is like a dome or half a ball!

This Ndebele house is more like a rectangular box than a cube.



Rondavel



Zulu



Ndebele

If the pictures used are drawings of houses, talk about the relationship of the objects and shapes and how they appear in the illustration. For example, parts of the object may be hidden from view because they are behind another part of the building or at the back or to the side.

### Modelling 3-D structures

Give learners play dough, plasticine or other kinds of modelling materials to copy similar designs of buildings and houses or to model designs they've come across in their own environments. Allow time for them to discuss and compare their models. Scaffold in the kind of shape and space language you would expect them to be able to use by this stage including descriptive language like straight, curved, pointy, flat and the use of terms like cubes, rectangular and triangular prisms, cylinders, faces, edges and corners.

All the walls are square I think, but you can only see two of them in the drawing because the other two are behind and at the side so you can't see them in this picture.



### Building 3-D structures

Give each group of learners an assortment of different 3-D objects, that include different kinds of prisms and cylinders and have them build 3-D models of buildings and houses. They can work as a group and then share their designs with the rest of the class. Ask questions that help them to 'de-construct' their models to the rest of the class. For example:

"What are the names of the blocks you used?"  
"What shape are their faces?" "How did they fit together?" "How many layers high or wide is your building?" "Are its edges straight or curved?"

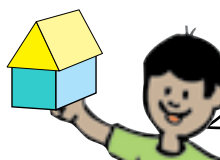

I used this block to make my roof. I know it's a triangular prism because two of the faces are triangles and the other 3 faces are rectangles.

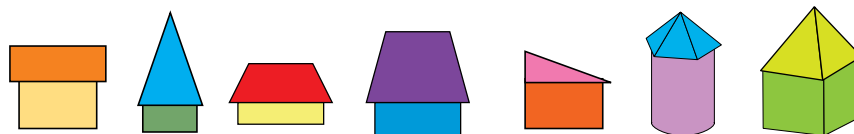

### Copying designs

Give each group of learners a collection of blocks. Make a folded cardboard screen for each group so that it can stand upright in the middle of the table. The group divides itself into two. The one half works together, choosing some of the blocks to build a model of their choice, behind the screen. They then describe their model to the other group of learners, who follow their description and work together to copy the design. They then remove the screen between them and check to see if the group was able to copy the design accurately or not. The groups then swap roles. As learners work, move around their groups and pay attention to the kind of language they use. Encourage them to be as precise as possible when giving their partners clues.

You say you used 3 prisms but how will the other group know if they were cubes, or rectangular or triangular prisms?

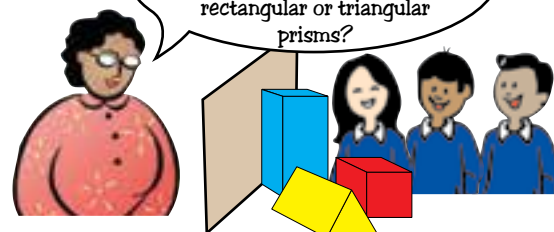

## Building with cubes

Build a design using four cubes or multilink blocks. Show the learners the design and ask them to use their blocks to copy it. Next, challenge them to see how many different designs they can make using the same four blocks but positioning them in different ways. If they are multilink cubes they can fit these together. The rule is that at least one face should join another.

Increase the number of blocks to five, six or seven and have them investigate how many different models with joining faces they can make.

## Drawings of cube structures

Prepare a worksheet that includes different designs made up of small cubes. Ask learners to say how many cubes are needed for each design. They then use cubes to build the models and check one another to see if they counted correctly and if their designs match the pictures in the worksheet.

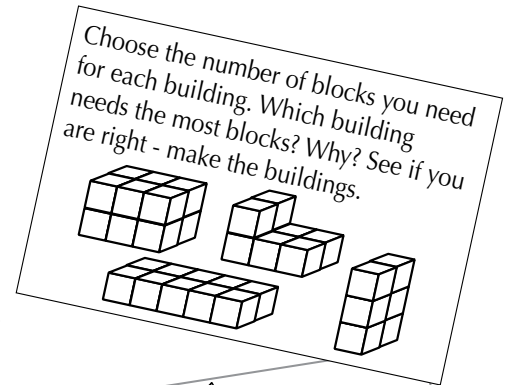

## Building skeleton shapes

Show learners how to construct a 3-D model using toothpicks or straws held together with prestik or plasticine. Show them pictures of different 3-D frameworks and let them see if they can copy these. Or make examples yourself they can use as a reference. Ask questions about the different designs: "How many edges and corners do they have? If you cover the frameworks with paper, how many faces will each model have? What shapes will they be?"

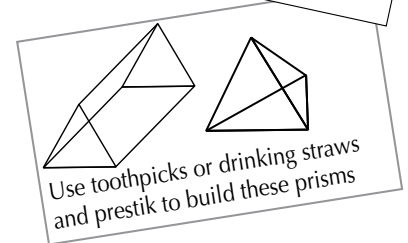

## 3. Building 2-D shapes

Make a worksheet that has some 'torn' shapes. Ask learners to draw what the shapes looked like before they were torn.

Give out sets of plastic or cardboard shapes for groups or pairs of learners. Give them some time to explore the shapes freely, putting different ones together to make new ones and making up designs and pictures of their own.

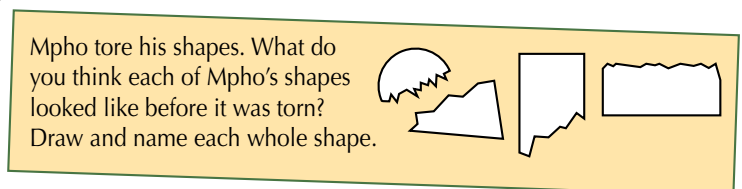

Next give them more guided instructions. For example: "Use only triangles like this to build these shapes":

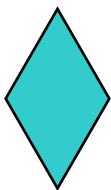
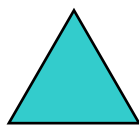

rhombus (diamond)

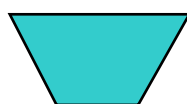

trapezium

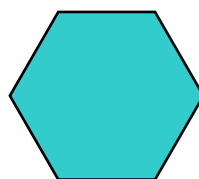

hexagon

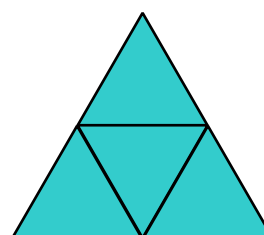

Use four of the triangles to make one large triangle.

## Grade 2: Shape and Space (Geometry)

They can then move the triangles around to make different designs or pictures.

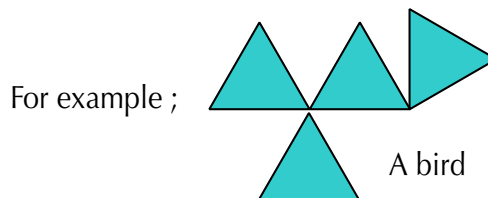

Now ask them to use four squares to make one big square or one long rectangle.

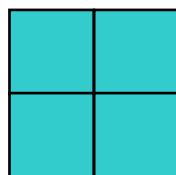

Ask learners to predict how many triangles like this  it would take to cover the big square or rectangle. Then let them build the shape to check if they were correct.



### Tangrams

Make a copy of this tangram to give out to each learner.

They can then cut out all the shapes neatly.

See how many of the shapes they can name correctly.

Ask them to see how they can use their shapes to make a cat like this:

Let learners then make up their own designs and ask their partner to see if they can copy them.

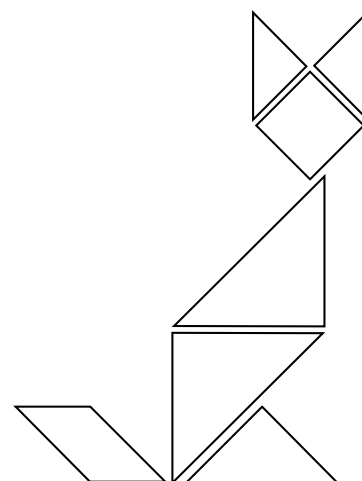
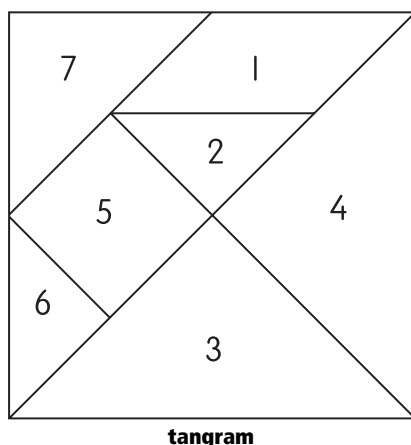

See Resources, p374.

## Skills and knowledge

The learner:

- Positions self within classroom environment or three-dimensional objects in relation to each other.
- Describes positional relationships (alone and/or as a member of a group or team) between three-dimensional objects or self and a peer.

## Suggested activities

### Position outside the classroom

#### Position in the school

Take learners outside. Ask questions about the positions of different objects in the environment. For example: "Where is the red car?" Learners should say: "Between the white car and the blue car".

Give learners turns to ask each other questions like this.

Let learners create their own obstacle course and verbalise their actions. For example: "I'm climbing over the tyre, walking on the beam, climbing through the hoop."

### Follow directions

Learners must follow your directions to move themselves into different positions. For example:

- move three steps forwards;
- make four jumps backwards;
- touch the arm of the person on your left;
- touch the leg of the person on your right;
- make a circle, face inwards, now face outwards, turn to the left and then to the right.

### Moving around the play ground

Place objects in the playground or in the classroom and let learners follow a series of directions, e.g. "Hop twice around the sandpit, jump over the ball, and go around the right side of the tree". Learners can take turns to give each other directions.

You can also place a long rope to form a trail around a series of objects. Learners can walk the trail and describe the route they take. They can then try to draw a picture of the route or draw other routes for their friends to follow and describe.

### Hide and seek

Play games like hide and seek or treasure hunt where you use directional language to give learners 'hints' about where to find each other or where to find the 'treasure'.

### Sand drawings

Learners follow your instructions to follow a path in the sand to create different 2-D shapes. For example, walk:

- a straight line going down;
- a straight line to the left;
- a straight line across to join the beginning of your first line.

They can choose their own shapes and ask their partners to follow their instructions to draw the shape.

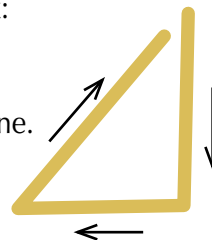

### Treasure Hunt

Hide a 'treasure' somewhere in the school grounds. Give learners a simplified map showing the main buildings and outside equipment in the playground like the swings or the taps. Give them directions to follow to find the 'treasure' you've hidden.



### Position inside the classroom

#### Left and right

Repeat songs and rhymes that learners may have learned in Grade R and 1 that help them to show and distinguish their left from their right when they are facing the front and when they turn around.

#### Simple Simon

Play the game 'Simple Simon' where you mime left and right actions that learners must follow. If they get them wrong they are out of the game. For example you say: "Simple Simon says put your right hand up". Learners follow by putting up their right hands and so on. But if you say "Simple Simon says put your left foot out" and you put your right foot out instead, and they copy you, they are out of the game.

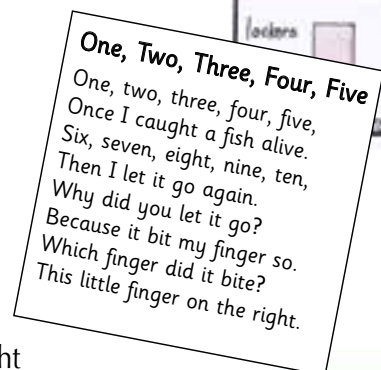

## Grade 2: Shape and Space (Geometry)

### Crossing the middle

Do more preparatory activities where learners have to cross their 'midline'. For example: "Put your right hand on your left knee, your left hand on your right foot."

### Moving objects around

Place an object behind the chair. Ask individual learners to say where the object is. Repeat with other positions to give learners practice using all the position words they've learned so far. Learners can then play in pairs. They take turns giving instructions for their partners to follow. For example: "Stand in front, behind, under, on top of the desk."

Use a variety of objects and geometric blocks to reinforce the vocabulary of position and the terminology to name 2-D shapes and 3-D objects. For example: "Put a cube to the left of the cylinder"

"Put the cube block underneath the triangular block, then a triangular prism above the cylinder."

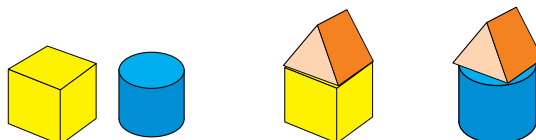

### Questions about positions

Ask learners questions about where to locate the position of different objects in relation to one another. For example:

- Is the clock higher or lower than the desk?
- What piece of furniture is right next to the door?
- What is above that?
- What things are lower than the window but higher than the desks?
- Put your ruler on the left hand side of your desk.
- What is to the right of the ruler?

### All in a row

Ask five learners to come up to the front of the class and stand in a row.

Ask questions like:

- Who is in the front?
- Who is two behind Ben?
- Who is behind Pule but in front of Khaya?
- Who comes before Pule but after Busi?
- Who is two in front of Khaya?

Introduce ordinal numbers at the same time. For example

- Who is 1st, 2nd, 3rd, 4th, 5th?
- Who is 2nd last in the row?
- Who is third from the front?

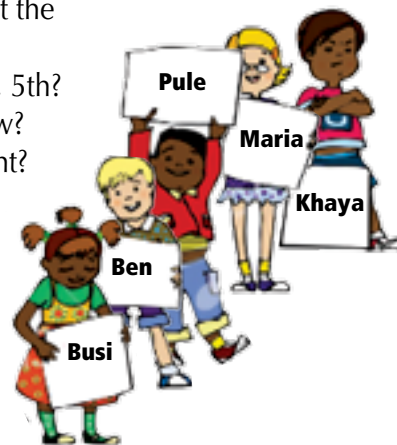

### Build and copy

Make a model using different shaped blocks and hide it under a cloth on the desk.

Give learners their own blocks. They must listen to your instructions and try to copy your model. For example:

- Take a square block and put a triangular block on top of it.
- Put a rectangular block behind the square block.
- Put another triangular block on top of the rectangular block.
- Place a cylinder on the left of the square.
- Place another triangular block to the right of the rectangular block.

When they are done, remove the cloth and check to see which learners copied your model correctly. Learners can then play the game in their groups giving each learner a turn to build a model and 'hide' it. They then give instructions to the group to see if they can copy it.



## Grade 2: Shape and Space (Geometry)

### True or False

Make a work card with rows of pictures in a grid.  
Give one card to each group of learners.  
Ask learners True or False questions about the positions of the pictures on the grid.

Learners can then take turns to make up similar True or False statements to ask one another.

Follow up by using the same grid to give learners practice writing words of position.

For example:

The face is \_\_\_\_\_ the clock

The flower is \_\_\_\_\_ the face

The pen is \_\_\_\_\_ the flower

If they answer False, they must then describe the correct position of the picture, For example:

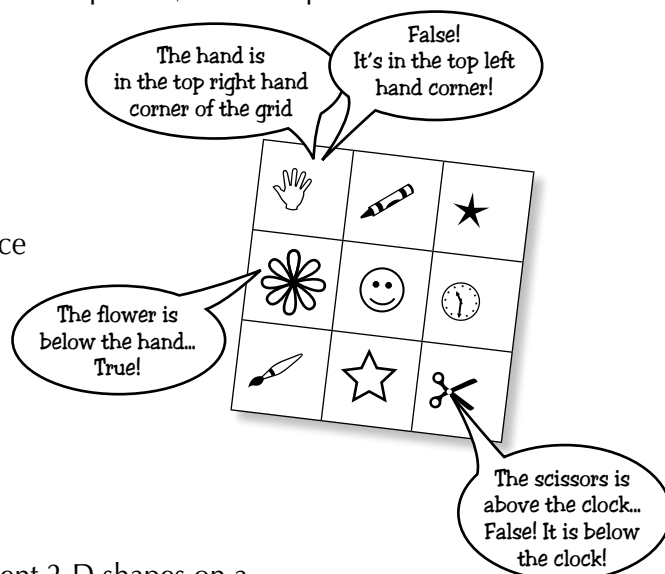

### Draw shapes in different positions

Give learners instructions to mark the positions of different 2-D shapes on a page of their books. For example:

- Draw a circle in the middle of the page.
- Draw a small triangle in the top left corner.
- Draw a circle underneath the triangle.
- Draw a square in the bottom right hand corner and a triangle above it.
- Draw a rectangle above the middle circle.
- Draw a diamond below the middle circle.
- Now draw another square to the left of the diamond.

See Resources, p375, for example to copy.

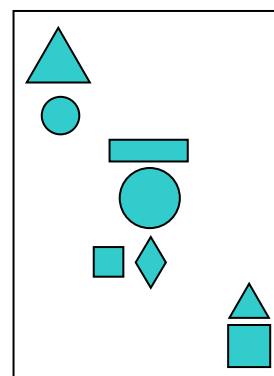

Learners can then check each other's work and take turns to describe the position of different shapes on the page.

### Moving positions on a grid

Give each learner a 10 x 10 grid, with a dot marking the middle of the page.

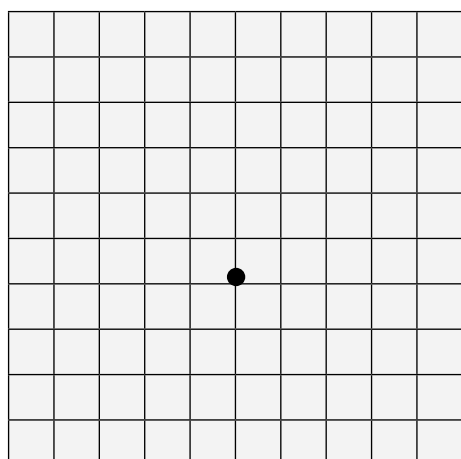

Ask them to place a counter on the dot and then listen to your directions on how to move it to different positions on the grid. After each move, they go back to the middle of the grid.

For example, move your counter:

- to a block near the bottom or near the top, or
- to a block near the left hand edge of the paper, or
- to a block in the top right hand corner, or
- three blocks down and four blocks along to the left, or
- five blocks along to the right and two squares up, or
- three rows down and three blocks along to the left, or
- five blocks to the right and one block down.









## Grade 2: Shape and Space (Geometry)

### Position and direction

#### Moving arrows

Start off by asking learners to draw arrows pointing in different directions in their books.

		
Pointing to the left	Pointing to the right	Pointing upwards
		
Pointing downwards	Slanting to the left	Slanting to the right

Design a cardboard circle with a moving arrow.

Pin the chart up on the board. Give learners turns to move the arrow to different positions.

For example:

- Move the arrow to the top of the circle. Make one full turn. Where do you land?
- Make a quarter turn to the left and then another quarter turn to the left. Where do you land?
- Move the arrow one quarter turn to the right. Now make a half turn to the left. Where do you land?

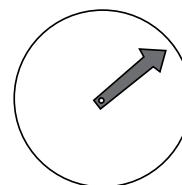

Repeat the same kinds of instructions, using the opposite directions.

#### Clockwise and anti-clockwise

Extend the activity by adapting the arrow chart to show the numerals 12, 3, 6 and 9 for quarter hour intervals. Explain to learners what we mean by the terms clockwise and anti-clockwise by moving the arrow both ways, starting from the 12 mark.

Give learners turns to move the arrow in different ways. For example:

- Start at 12. Make a quarter turn in a clockwise direction. Where do you land?
- Make a quarter turn in an anti-clockwise direction. Where do you land?
- Make a half turn both ways. Where do you land each time?

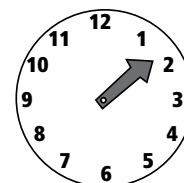

#### Tracing a path

Make a worksheet where learners must find as many ways as possible to trace a path with their pencils to get from A to B. Make some rules.

For example, they cannot cut across a block. They can only draw on the lines.

They can then count and compare their different ways to find which route is the shortest, the longest or which are the same.

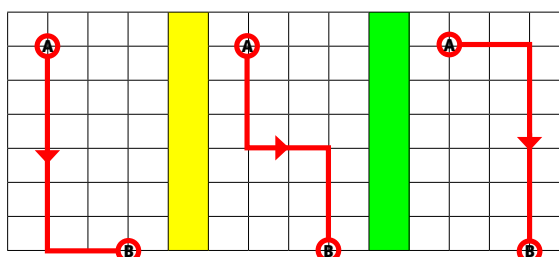

#### Describe your route

Learners explain to the class the route they have to follow, e.g. to get to the toilet/home: "Left at the door, straight towards the stairs. Up the stairs, right at the top of the stairs," or ask them to describe their journey from the school gate to your classroom and to say what they see.

### Models of maps

Learners can use building blocks to build 3-D models of, for example, the way the furniture is arranged in their class. Discuss which blocks will represent various objects (e.g. tables, chairs or shelves) and how they need to place them in relation to each other. They should describe their maps to each other using the language for position.

### Making the link between models and maps

Help learners to relate their models to representations by drawing simple maps of their constructions. You can also help learners to make the link between the position of their objects and drawing maps by:

- letting learners put out two or three shapes on a sheet of paper, trace around and label each shape;
- letting learners dip their blocks in paint and stamp 'footprints' of their buildings in the correct relationship to each other.

In both cases, let learners describe the shapes of each object, e.g. "When I traced round the house I drew a square. I drew a circle around the tower". They can also describe the relative position of the various objects on their 'maps', e.g. "My square for the house is on the right and my circle for the tower is on the left".

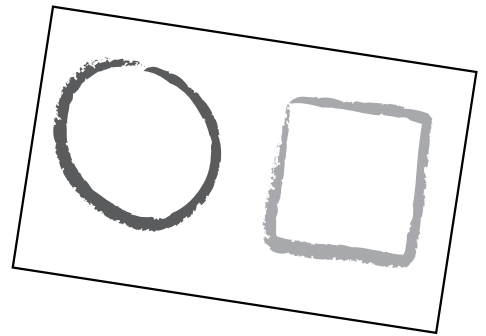

## Grade 2: Shape and Space (Geometry)

### Vocabulary

If you do not teach in English, use equivalents in your language of instruction.

#### Grade 1:

Understand and use these words in practical contexts:

- shape, pattern, flat, curved, round, straight
- solid, corner, face, edge
- rounded, pointed
- roll, slide
- build
- everyday language to name and sort properties of 3-D objects and 2-D shapes such as cubes, spheres, circles, triangles, rectangles (squares)
- front, back, right, left, midline
- top, bottom, across, up and down, from side to side
- down the middle, across the middle, midline
- reflect, mirror, dotted line, equal parts or halves.
- in front of, behind, side, next to, beside, on top of, above, underneath, below, inside, outside, to the left of, to the right of, left hand side, right hand side
- to, from, towards, away from, over, under, underneath, above, below, on, in, outside, inside, in front, behind, beside, before, after, next to, opposite, between, close by, far away, far apart, middle, centre, edge, corner, sideways, up down, forwards, backwards, across, along, around, through.

#### Grade 2 - add the following to the Grade 1 vocabulary:

- rectangular, triangular
- squared prisms
- a square is a special kind of rectangle with all sides the same length
- a square prism, a rectangular prism and a triangular prism
- other names of shapes that they may come across like rhombus (diamond), hexagon, trapezium or kite
- tangram
- symmetry, symmetrical, non-symmetry, non-symmetrical
- views from the front, from the back, from the sides, from the top, position, view, changes, looks different.
- quarter turns, half turns, full turns, clockwise, anti-clockwise.

#### Grade 3 - add the following to the Grade 1 and 2 vocabulary:

- balance, not balanced, facing opposite directions
- vertical, horizontal, diagonal
- map, point, distance, aerial view, floor plan
- area, perimeter

### Resources

- 3-D blocks of different shapes and sizes including:
  - cubes, cuboids (rectangular prisms)
  - triangular prisms, spheres and cylinders
- cartons and containers of different shapes and sizes
- other construction materials like Lego
- balls of different sizes and other spherical objects that roll
- coloured shape blocks or paper cut-out shapes that include triangles, rectangles, squares and circles
- geoboards
- examples of a circle, triangle, square and rectangle with labels for the wall
- number cards; shapes; posters and pictures of different 3-D objects and shapes

## Grade 2: Shape and Space (Geometry)

- play dough, plasticine or other modelling materials
- crayons, paper, string, a feely bag to hide different shapes in
- multilink cubes or similar materials that join together on each side
- full length mirror; mirrors
- metre stick or straight rod, the length of an average learner's height
- newsprint, crayons, paint, paintbrushes
- collection of objects and pictures that are both symmetrical and asymmetrical
- beads, threading string
- worksheets with half drawn objects that are symmetrical for learners to complete
- an arrow chart with a moving arrow
- bean bags
- any objects around the classroom or school environment that learners can easily move into different positions
- songs and rhymes you can use to teach learners the vocabulary of position.

### **Additional resources needed for Grade 2:**

- pictures with different views
- worksheets with block models
- grid paper

### **Additional resources needed for Grade 3:**

- photographs, symmetrical artefacts
- samples of different kinds of maps
- grid picture game boards and cards

The learner will be able to use appropriate measuring units, instruments and formulae in a variety of contexts.

## Skills and knowledge

The learner:

- Reads analogue and digital time in hours and minutes.
- Calculates elapsed time in:
  - a) hours and minutes using clocks;
  - b) days, weeks and months using calendars.

The vocabulary that learners need to understand and use for these skills is listed at the end of the suggested activities. You will find it helpful to make flash cards with key vocabulary words to support the teaching and learning process. A list of the resources you will need for the activities is also provided.

## Suggested activities

### 1. Clock activities

#### Drawing a clock

The purpose of this activity is to stimulate the learner's mental picture of a clock. If you have a clock in the classroom, remove it or cover it up. Provide learners with something round, like a plate, to trace a circle onto their paper, and ask learners to draw a clock. They should make their drawing as detailed and accurate as they can, and label any parts they can.

When they are finished, uncover or replace the real clock. Ask them to identify how their clock and the real clock are alike and different.



#### Place value in time

In base 10 we can count up to 9 in the units place. If we then want to add 1 more we have to put a 0 in the units place and a one in the 10s place. We use base 10 for most things we count, but a few things are counted in different bases. Seconds and minutes are counted in base 60. That means we can count up to 59 seconds, but if we want to add one more we would put a 0 in the seconds place and a 1 in the minutes place. And if we had 59 minutes and added one more minute we would have 0 in the minutes and 1 in the hours place.

#### Time spinner game

Here is a game to play to give learners experience adding seconds and minutes in base 60.

- Learners play in pairs. Give each pair a Seconds or Minutes spinner that goes up in 5s. [See Resources, p378.](#)

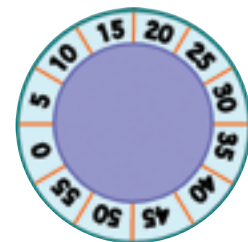

- Each learner must prepare a score sheet like the one shown on the right.
- The players take turns spinning the spinner. The player must use the number that appears on the spinner, but he or she can choose whether the number will represent seconds or minutes.
- Both players must play 10 rounds, each time adding the number spun to either the seconds column or the minutes column. The goal is to finish with a total as close to 1 hour as possible, *without going over that target*.

Spin	Hours	Minutes	Seconds
1			
2			
3			
4			
5			
6			
7			
8			
9			
10			

**Expanded opportunity**

Choose a different target, larger or smaller than 1 hour.

Start with a certain amount of time and, after each spin subtract the amount shown on the spinner, either from the seconds or from the minutes. The goal for the subtraction game will be to come closest to zero *without going below zero*.

**Clock number line**

Give learners a number line that looks like this



Have them count the number of long lines and write the numbers 0-12 under them.

Then have the learners count all the lines, long and short, and write the numbers 0-60 above the lines. Have them practise counting the lines by 5s.

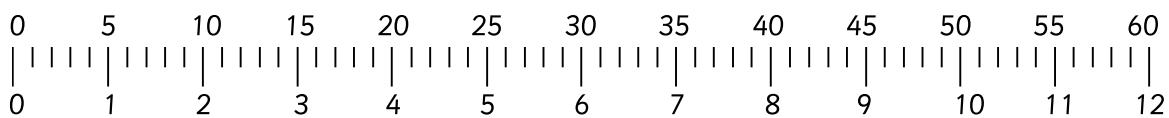

**Making a clock**

Give learners a circle cut from card with the same marks on it. Learners follow these steps:

**Step 1**

Wrap the number line around the circle, with the ends meeting at the top, so that 1 and 12 meet up and 0 and 60 meet up. Observe the position of the other numbers. Where is 15? Where is 30? Now they may put the number line aside.

**Step 2**

Write the numbers 1-12 on the clock face, inside the long lines.

**Step 3**

Write the numbers 5, 10, 15, etc. up to 55, outside the long lines. At the very top, they should write 0. Remind them that 59 minutes plus 1 minute is 1 hour and 0 minutes.

**Step 4**

Cut out and attach the hour hand. Explain that this is the hand that counts the hours, and it takes one hour to move from one number to the next. Ask questions like: "What can you do in one hour? How long does it take to make a complete circle? How many times does the hour hand go around in a day?"

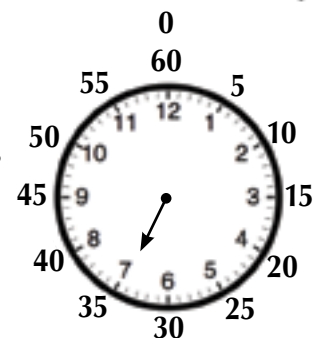

See Resources, p345 and 378.

Discuss 'clockwise' and 'anti-clockwise'.



## Grade 2: Measurement

Tell a story about one day in the life of a child, giving the times to the hour and writing them on the board in analogue form and in words, as well as what happens at that time. Call on a learner to move the hour hand of the class clock to the correct position. The rest of the learners move the hour hand on their own clocks to the right position.

### *It's all in a day*

The day of the party, Queenie got up at 7 o'clock. She got dressed and had a good breakfast and arrived at school at 8 o'clock. Her best friend, Liziwe, wasn't in class. Where was she? Queenie would ask Liziwe's sister, who was in the 4th grade, since her class usually had break at 10 o'clock, the same time as Queenie's class did.

Invent other stories using times to the hour. As an extension, ask learners to make a schedule of their own weekend day.

7:00	seven o'clock	wake up
8:00	eight o'clock	arrive at school
10:00	ten o'clock	break

### Step 5

Attach the minute hand. Explain that this is the hand that counts the minutes. It takes one minute to move from one short line to the next. Ask questions like: "What can you do in a minute? How long will it take to make a complete circle? How many times does the minute hand go around in a day?"

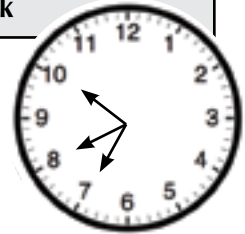
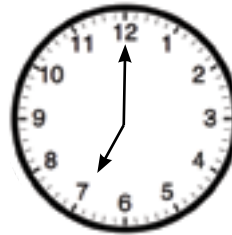

## 2. Measuring time

### Sand timers

Make sand timers. Use two 500 ml water bottles, fine sand and strong tape. Make a few small holes in one lid and tape the two bottles together. Calibrate them so that they are a known time – one minute, perhaps. Then use the timers to measure activities. "How many jumping jacks can you do in that amount of time? How many times can you write your name? How many times do we have to turn the timer over to equal the time it takes to do the chores?"

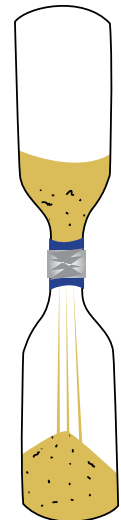

### How long is a minute?

Use a timer or stopwatch. Give learners a sense of how long a minute lasts by asking them to put their heads on their desks with their eyes closed and silently raising them when they think one minute has passed. Tell them each how close they were and then let them try it again. Give them a variety of tasks and let them see how much they can do in a minute.

How many of this week's spelling words can they write in a minute? How many jumping jacks? Choose a song they all know. How many verses can they sing in a minute? Do they think they can say the whole alphabet in a minute? If so, how many times? Let them try it. How many times can they bounce a ball? Write their names?



Then discuss the subjectivity of time. When does a minute seem like a second? When does it seem like an hour?

## Stories about time

Give learners a variety of opportunities to practise telling time in hours and minutes, as above, but in this case invent stories with events in hours and minutes. Start with a story that takes place within one hour and later progress to stories that happen over several hours. Again, write each event in analogue notation and in words, as well as noting what happens at that time. Invite a learner to set both hands in the correct position.



### A Cake for Grandma

Nompie and her sister Grace are making a cake for their grandmother's birthday, but they want it to be a surprise. Their grandmother has just left the house, but she will be back in exactly an hour. Can they make the cake and hide it in time?

Their grandmother leaves the house at 3 o'clock. The girls quickly take out all the ingredients. That takes 5 minutes, so by 3:05 they are ready to start cooking.

The first step is to turn on the oven to preheat, and to grease and line the pans. That takes another 5 minutes, so they finish that step at 3:10.

Then they must measure the butter and sugar and mix them together, which takes another 5 minutes. They are done with that step at 3:15.

Next they must add the eggs, one at a time, and mix them in with the butter and sugar, and then measure the vanilla essence and add it. Another five minutes - this is taking more time than they thought! It's already 3:20 and the cake isn't even in the oven yet!

They still have to measure the flour, salt, and baking powder and sift them together, measure the milk, and then add them, in turns, to the batter. Once it is well mixed, they pour the batter into the pans and carefully put the pans into the oven. The recipe said the cake would take 35 minutes to cook. What time is it? Oh, no! It's already 3:30. Their grandmother will be back at 4:00. If she sees the cake now, it will spoil the surprise. The girls have to think of something. While they are thinking, they make the icing, and then wash the dishes and put all the 'evidence' away.

"We just have to find a way to delay Grandmother for a few more minutes," said Grace. "Can't you think of something?" Suddenly Nompie's frown turned into a beautiful smile. "What?" asked Grace. "I have a brilliant idea!" said Nompie. Grace knew, from hard experience, that whenever her younger sister had a brilliant idea, it meant trouble...

3:00	three o'clock	grandmother leaves the house
3:05	three five	The girls put the ingredients out
3:10	three ten	oven preheating and pans ready
3:15	three fifteen	butter and sugar mixed
3:20	three twenty	eggs and vanilla mixed in
3:30	three thirty	cake is in the oven

As they arrange the hands on their clocks, encourage learners to put the hour hand in a realistic position – half way between 3 and 4 for 3:30, for example. Explain that the hour gradually moves from 3 to 4. It doesn't jump across suddenly at 4 o'clock.

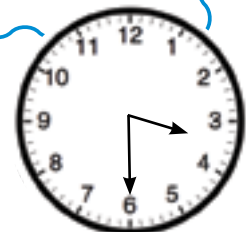

Invent a variety of stories to illustrate reading time in hours and minutes and also ask learners to make up their own stories and use their clocks to indicate the times in their stories.

## Grade 2: Measurement

### Practice for telling the time

The best practice for telling time is to tell time in a context that has meaning for the learners. One of the most effective things you can do is to talk about time constantly. Say the time, ask the learners what time it is now (even if you asked them only ten minutes earlier), ask learners what time it will be 15 minutes from now, ask the learners what time it will be two hours from now. The more real the time is for the learners, the better the learning experience. The school day provides unlimited opportunities for meaningful experiences of telling time.

### The second hand

Mention that some clocks have another hand that helps us tell time even more precisely. It goes all the way around in one minute and counts out sixty seconds. Ask learners for examples of when you would want to time things in seconds, when you want to know things to the nearest minute, and when you would want to time something to the nearest hour, day, week, month, or year.

### AM and PM

a.m. is short for **ante meridian** and p.m. stand for **post meridian**. Ante means before and post means after, so a.m. means before the meridian and p.m. means after the meridian. So what's the **meridian**? Make a sky dome (See [Resources](#)) or use a large umbrella to represent the sky. The bottom rim of the umbrella fabric represents the horizon, where the sky meets the earth at sunrise and at sunset. Indicate the east and the west points of the horizon on the umbrella or sky dome. Show the path the sun takes as it rises in the East and sets in the West. Now indicate the North and South points on the horizon. The meridian is the line of the umbrella that runs from the South horizon to the very top, and then from the top down to the North horizon.

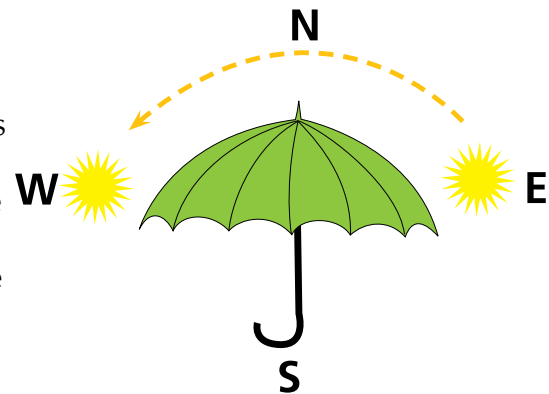

Now that we know what the meridian is, let's look again at the sun's path. The meridian is the midpoint of the sun's symmetrical daily path, half way between sunrise and sunset. The sun crosses the meridian exactly at noon. That's why everything before noon is called **ante meridian** and everything after noon is called **post meridian**.

Explain the meridian to your learners and help them develop their understanding by asking questions like: "Where is the meridian in the sky when you're in the schoolyard? Where is the meridian in relation to the walls and ceiling when you're inside the classroom? Where is the meridian in the sky when you are outside at home?"

### Shadow time

Assess prior knowledge of how a shadow changes during the day. Review the way the shadow changes during day, and why.

Find a permanent fixture in the schoolyard that has a shadow that can be measured throughout the year. A flagpole or pole for a basketball hoop would be ideal. One sunny day take the class outside at intervals to trace the shadow with chalk.

Then choose a certain hour of the day to make a series of monthly observations. Make a drawing of the shadow at that time of day, and then observe the shadow at the same hour of the day at monthly intervals. Let learners record the monthly observations (e.g. in rough drawings or by measuring the shadow length). Ask: "How is the shadow the same? How is it different?"

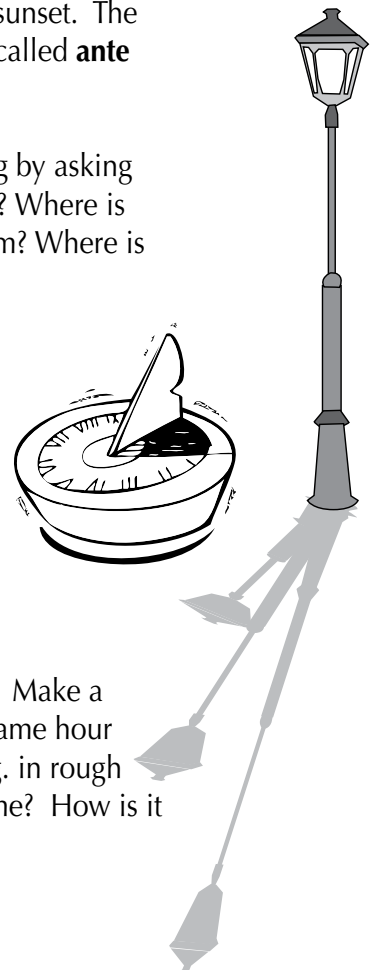

### 3. Time and fractions

#### The linear clock

The details of this activity depend upon the materials you have in your classroom. Each pair of learners will need 60 items that measure one unit, and 12 items that are 5 units long. If you have unit cubes and rods 5 units long, use those. Or you can use counters and make paper strips equal in length to 5 counters.

Give each learner a length of tape or a paper strip exactly equal in length to 60 of your cubes or counters. Have them mark one end 'start' and the other end 'end'. Then have the learners fold the tape in half and mark the midpoint, labelling it  $\frac{1}{2}$ . Have them write 0 at the start, and  $\frac{2}{2}$  at the end.

Have the learners fold each half in half, and mark the first fold  $\frac{1}{4}$ , at the  $\frac{1}{2}$  mark they should add  $= \frac{2}{4}$ , and the third fold they should label  $\frac{3}{4}$ . They should write 0 at the start, and at the end, they should add  $= \frac{4}{4}$ .

Explain that this is a linear clock. Have the learners work in pairs to measure the tape with their counters. How many counters fit along the linear clock? (60) What does 60 have to do with clocks? 60 is the number of minutes in an hour, so they will use this length of paper to investigate minutes and hours. Each counter stands for a minute and the whole long paper stands for an hour.

How many counters in  $\frac{1}{2}$  the length of paper (how many minutes in  $\frac{1}{2}$  an hour)? Use the counters to measure, then use the counters to find out how many minutes in  $\frac{1}{4}$  hour, and in  $\frac{3}{4}$  hour.

How many counters in each 5 unit measure? How many counters in the whole hour? In  $\frac{1}{2}$  hour?  $\frac{1}{4}$  hour?  $\frac{3}{4}$  hour?

#### Connecting time to fractions

Fraction concepts - whole, half and fourth are important in understanding clock time. Copy the unnumbered clock face onto different coloured paper. Have learners cut out a circle, fold it in half, and explore the relationship to the numbered clock face.

- One out of two equal parts is one half, or  $\frac{1}{2}$ . One half of one hour is the same as 30 minutes.
- Two out of two equal pieces are two halves,  $\frac{2}{2}$ , or one whole. Two half hours equal one whole hour. Thirty minutes plus 30 minutes equal 60 minutes, or one hour.
- One out of four equal pieces is the same as one fourth, or  $\frac{1}{4}$ , or one quarter. One-quarter hour is fifteen minutes. Two quarter hours are the same as one half hour. Fifteen minutes plus 15 minutes are 30 minutes. Three quarters of an hour is 15 + 15 + 15 minutes, or 45 minutes. A quarter to an hour is fifteen minutes before the hour.

As the learners explore with the clock fraction pieces, encourage them to observe, show and discuss the fact that two quarters make one half, that 3 quarters is more than one half and less than one whole, etc. Use fraction notation as well as words,  $\frac{1}{2} + \frac{1}{2} = 1$ ,  $\frac{1}{4} + \frac{1}{4} = \frac{1}{2}$ .

Ask the learners to think about the clock face as a round race track. If you

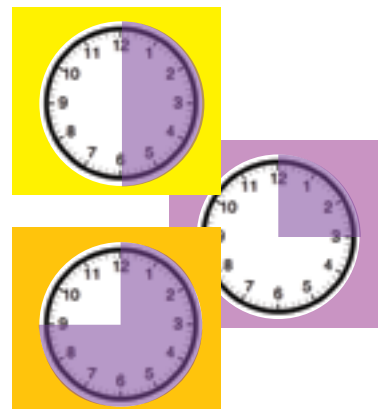
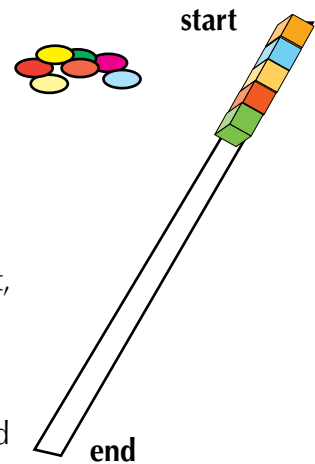

## Grade 2: Measurement

have run around one quarter of a lap, how much further do you have to go to reach half way around? Three quarters of the way? All the way around?

If you have gone three-quarters of the way around, how much farther do you have to go to complete the lap? How much more than one half is three quarters?

### 24-hour time

One way to tell time is to use a.m. and p.m. Another way is to use a 24 hour clock. Ask learners to think about why you might want to use a 24 hour clock sometimes, instead of using a.m. and p.m..

Give learners many opportunities to use 24-hour time. Try to find things that they might be interested in, such as schedules of sporting events and TV programmes, that are reported in 24-hour time.

Play games involving conversions between 24-hour time and a.m./p.m. time, such as **Concentration**, where they must find the matching times, or **Bingo** where the time is called in a.m./p.m. and they must find it on their Bingo card in 24-hour time, or vice versa.

## 4. Time calculations

Give learners time calculations in context. Use every opportunity in the school day to give learners practice in calculating elapsed time, both in hours and minutes, and in days, weeks, and months.

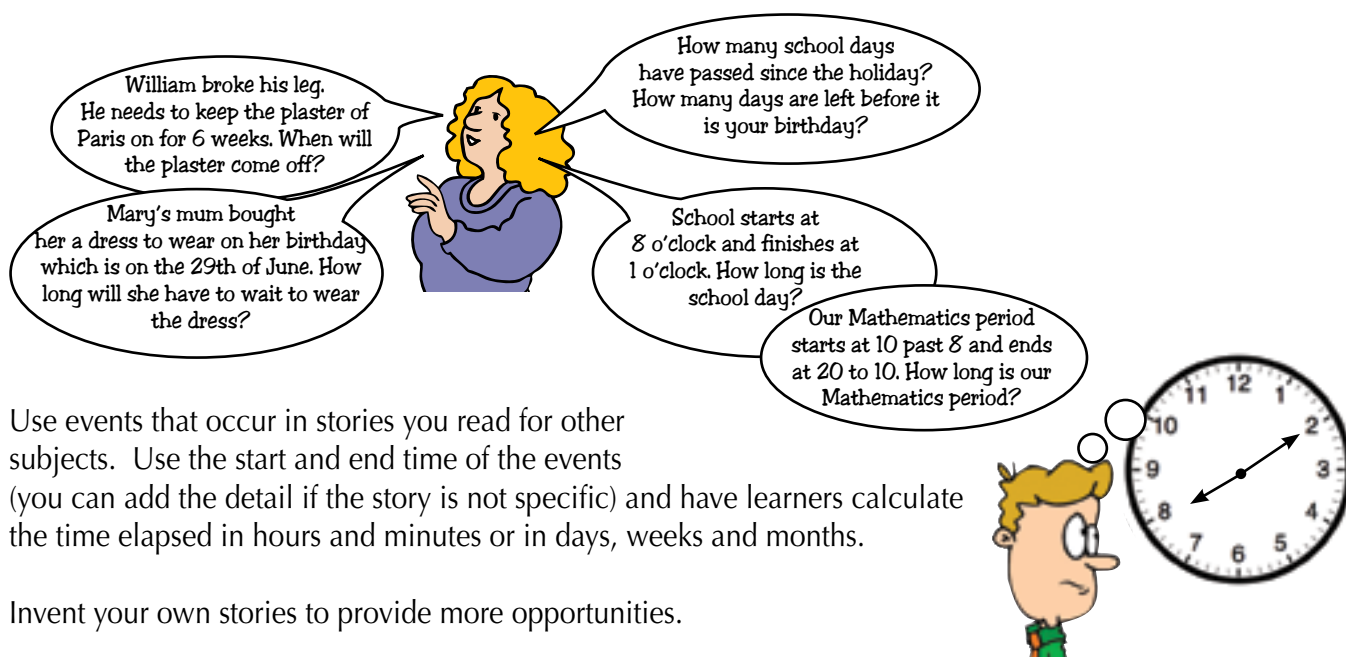

William broke his leg. He needs to keep the plaster of Paris on for 6 weeks. When will the plaster come off?

Mary's mum bought her a dress to wear on her birthday which is on the 29th of June. How long will she have to wait to wear the dress?

How many school days have passed since the holiday? How many days are left before it is your birthday?

School starts at 8 o'clock and finishes at 1 o'clock. How long is the school day?

Our Mathematics period starts at 10 past 8 and ends at 20 to 10. How long is our Mathematics period?

Use events that occur in stories you read for other subjects. Use the start and end time of the events (you can add the detail if the story is not specific) and have learners calculate the time elapsed in hours and minutes or in days, weeks and months.

Invent your own stories to provide more opportunities.

Learners should use their own clocks to calculate the time elapsed, or to check their pencil and paper calculation. Learners should use their own calendars to calculate or to check their calculations of days, weeks and months.



## Skills and knowledge

### The learner:

- Names in order the days of the week and the months of the year.

## Suggested activities

### 1. Days of the week

- Introduce the day names in the languages most familiar to your learners. What do the day names mean? Which are days for rest and worship in the cultures of your learners?
- Sunday and Monday honour the sun and the moon. The other five week days, are named for Norse gods, but the 7-day week is related to the Judeo-Christian-Islamic story of creation, in which God created heaven and earth in six days and rested on the 7<sup>th</sup>. Discuss creation stories from other local cultures.
- Take every opportunity to encourage learners to identify the day of the week, when discussing the calendar and weather chart, and throughout the day.
- Give learners cards with the days of the week on them and let the learners put them in the correct order.
- Relate the days of the week to yesterday, today and tomorrow.

Yesterday	Today	Tomorrow
	Sunday	
		Tuesday
Monday		
	Wednesday	
		Friday
Thursday		
	Saturday	

Today is Tuesday.  
We are having a guest in our class in two days. What day will that be?



We will have art on Thursday and a party the next day. What day is the party?

Monday

Tuesday

Wednesday

Sunday

- Discuss which school activities happen regularly on a particular day of the week, and what learners do at home on the weekends.
- Teach the spelling of the days of the week, and the abbreviations.
- Sing songs and recite poems about the days of the week.

#### A Week of Birthdays

Monday's child is fair of face,  
Tuesday's child is full of grace,  
Wednesday's child is full of woe,  
Thursday's child has far to go,  
Friday's child is loving and giving,  
Saturday's child works hard for a living,  
But the child that's born on the Sabbath day  
Is bonny and blithe, and good and gay.

#### Sneezing

If you sneeze on Monday,  
you sneeze for danger;  
Sneeze on a Tuesday,  
kiss a stranger;  
Sneeze on a Wednesday,  
sneeze for a letter;  
Sneeze on a Thursday,  
something better.  
Sneeze on a Friday,  
sneeze for sorrow;  
Sneeze on a Saturday,  
joy tomorrow.

### 2. Months of the year

Introduce the month names in all of the languages familiar to your learners. What do the names mean?

- Learn the names of the months in the languages most familiar to your learners.



## Grade 2: Measurement

- Practise spelling the months. Introduce the abbreviations for the months. Give learners cards with the month names and let them put the cards in the correct order.
- Recite poems and sing songs with the names of the months.

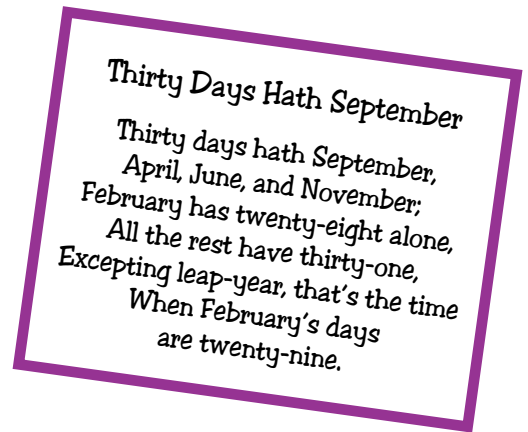

The oldest artefact of our human ancestors using mathematics is the Ishango bone. It was carved more than 20 000 years ago in the region near the border between Uganda and Congo and appears to be a lunar calendar. Many cultures view the moon as divine. It also governs the tides; so observing the moon is of great importance to sailors and fishermen.



Ask learners for their ideas about what ways the moon would be important to people long ago.

Although the sun's path changes somewhat during the year, it always gives plenty of light from sunrise to sunset. That is why it represents what is constant and reliable in many cultures. The moon represents what is inconstant. When the moon is full it gives off enough light to do most things we do in the daytime – if there are no clouds you can even read by the light of a full moon. But after the full moon, its light grows less and less until it is so dark at night that you can't even see a person sitting next to you. In many cultures the moon is associated with what is uncertain and changeable.

The surface of the moon has craters and mountains. When people look at the moon they often see an image, but people from different cultures see different things. Europeans see the face of a man. In many South African traditions the markings on the moon look like a man or woman carrying a bundle of sticks. The Tswana saw a woman carrying a child, who was caught gathering wood when she should have been at a sacred festival. In Sotho, Tswana, Venda tradition, when the moon was a crescent and getting larger (*Nwedzana* is a name for the waxing crescent phase), if the horns pointed up when the new crescent was sighted in the evening sky, it was holding up all kinds of disease, and when the horns were tipped down, the moon was a basin pouring illness over the world.

The Xhosa believed that each month's new moon was really new, that it came from the place where all the future moons were, in a large pit inside the sea. In Bushman legend the moon is a man who has angered the sun. Every month the moon grows round and full, but the sun's knife then cuts away pieces until finally only a tiny piece is left, which the moon pleads should be left for his children. It is from this piece that the moon gradually grows again to become full.



### 3. The moon's phases (expanded opportunity)

Ask learners for their ideas about what causes the moon to change phases. Accept all answers.

Then do this activity. To be effective this activity requires blocking the light from the windows by covering them with something opaque. Aluminium foil or black paper work well. Each pair of learners needs a moon model – a ping pong ball attached to a stick with prestik, or a styrofoam ball on a skewer. It should be white and smooth and perfectly spherical. With the windows darkened, put a lamp (the sun) on a stand in the centre of the room. One member of each pair of learners will be the earth based observer. Each observer is the earth for his/her partner. They will sit in their chairs in a circle around the lamp, recording what they observe. The other member of the pair will move the moon model around the earth.

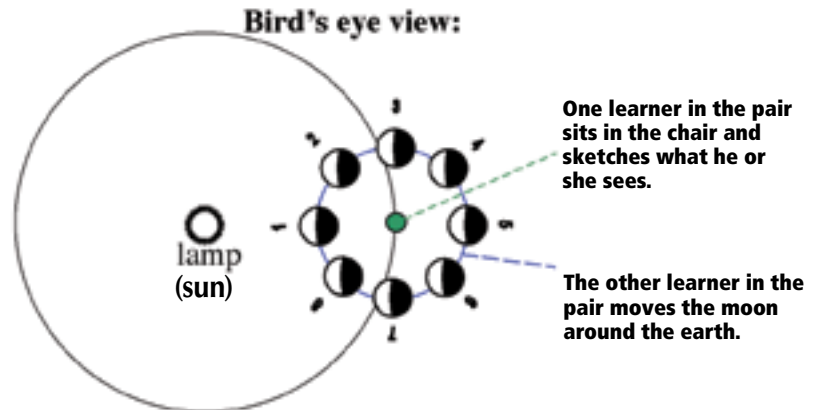

**What the learner-observer should see and draw.**



The purpose of this activity is not for the learners to remember the names of the moon's phases, but to observe that a sphere like the moon that is illuminated from one side will appear as a full circle, a half circle, or something between, or as a crescent or a shape between a half circle and a crescent, or it won't be visible at all, depending upon the position from which we view it.

### Skills and knowledge

#### The learner:

- Sequences events according to days, weeks, months and years.

### Suggested activities

#### 1. Ordering time

- When you read a story, list the major events in the plot, in no particular order, and have learners put them in the correct sequence, either on a timeline or by sorting cards.
- Ask learners to put themselves in order according to their birthdays. Don't tell them how to do it. Let them work out their own method. Then make a timeline of their birth dates, taking into account the year as well as the month and day.
- Make timelines of everything: of the events in a story you read, of the stages of the bean's growth, of the school year, the school week, the school day, the months of the year and the seasons, of holidays, of historical events, of each learner's life.

### Skills and knowledge

#### The learner:

- Identifies important dates on calendars including dates of:
  - a) religious festivals;
  - b) historical events.

### Suggested activities

#### 2. Important dates

- Have learners work in groups to plan a series of postage stamps in honour of holidays, either secular or religious.
- Discuss local secular holidays. Read to learners, or have them read, passages about the historic event being commemorated.
- Discuss local religious holidays. Read to learners, or have them read, passages about the meaning of the holiday and how it is celebrated. Some of the holidays you might consider are Christmas, Easter, Ramadam, Eid-ul-Fitr, Diwali, Holi, Chinese New Year, Passover, and Yom Kippur.
  - What do people do to celebrate these holidays?
  - When do people fast?
  - What kinds of foods do people eat?
  - What do the foods represent? If you can prepare some recipes it would be great practice in measuring.
  - What kinds of decorations do they make? You might make some decorations or greeting cards.
  - Do they buy new clothes? What kind of clothes do they traditionally wear? Draw the clothes or make them from paper collage.
- In addition to putting the dates on the calendar and calculating how long until a holiday arrives, or how long between, say, the start of Ramadan and Eid-ul-Fitr, help learners find out which holidays happen on the same day every year, which ones happen on different days but always in the same season, and which ones move continuously, even through the whole year.



## Skills and knowledge

### The learner:

- Estimates, measures, compares and orders three-dimensional objects using non-standard and standard measures:
  - a) mass (e.g. bricks, sand bags);
  - b) capacity (e.g. spoons, cups);
  - c) length (e.g. hand spans, footsteps).

## Suggested activities

### 1. Measuring for a purpose

The best activities are the ones that involve meaningful measurements, for example:

- Will this desk that we want to move fit through that door?
- Will those books fit in the remaining space on the shelf?
- You could measure distances within the school and grounds and make signs to direct visitors.

Parking: 30 metres

Principal's Office: Turn right, then 40 metres on your right.

If we want a poster big enough to hold everyone's birthday, but small enough to fit on the door, which size poster paper should we use?



### 2. Optical illusions and visual puzzles

These provide excellent challenges that help to develop measurement reasoning.

Provide challenging activities that encourage learners to reason about measurements and to make indirect comparisons.

Also use pictures to stimulate and assess measurement reasoning:

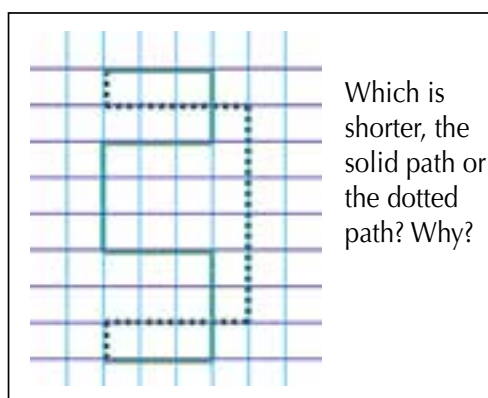
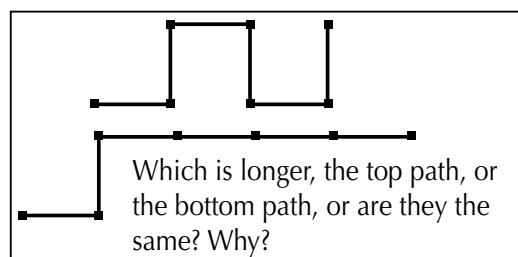
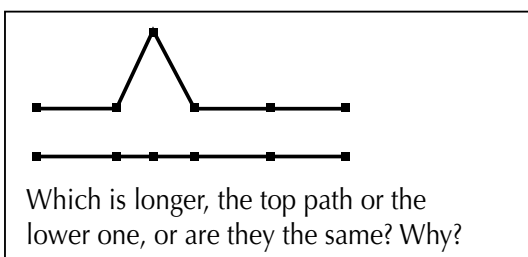
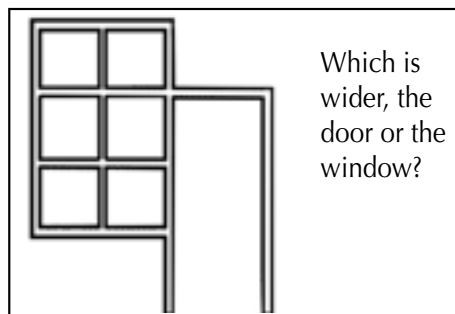
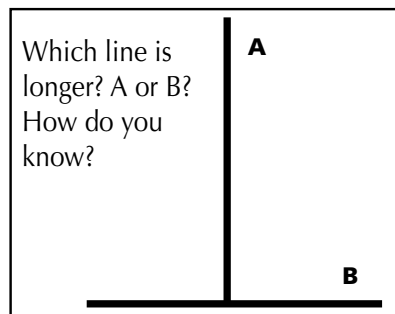

Questions like these are not asking the learner to measure, but rather to reason about measuring. By asking learners individually about their thinking you will be able to find out how they are thinking about measuring length.

(These assessment tasks are adapted from various articles by Michael Battista.)

## Grade 2: Measurement

Here are examples of the kind of questions that will help you assess learners' understanding of unit iteration.

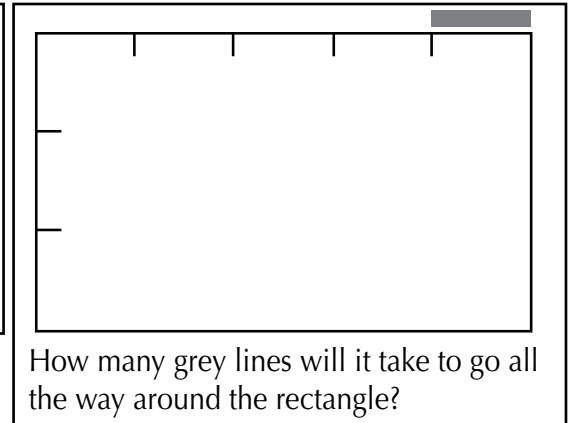
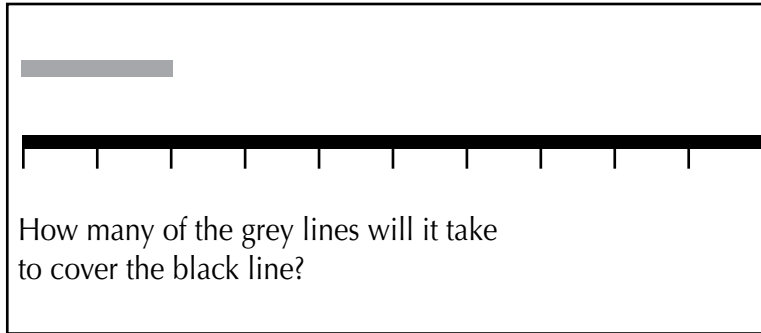

### 3a) Mass

Understanding how heavy things are is a practical life skill necessary for moving about in the world. Early experiences with a balance are key to developing intuition of the 'how muchness' of mass.

The balance is also the model of equality and inequality. Experiences with the balance are important for developing an understanding of number sentences now, and for understanding algebra later.

Give learners plenty of time for free play with the balance.

They can make their own balance from a coat hanger and two 2-litre cold drink bottles with the tops removed about  $\frac{1}{3}$  of the way from the bottom. Punch 3 equidistant holes in the rim of each bottle and tie the 3 strings to the arms of the coat hanger. The learners should test their balance with 2 items of known equal weight. If one side hangs lower, they can move the string a little toward the centre, or move the string of the side that is too high out a little. When the two sides hang exactly equal, fix the string to the wood with a little glue. The classroom balance is probably more accurate for small masses, so it is best to give learners as much experience as possible with both learners' own balances and commercial balances.



Encourage learners to experiment to get a sense of what happens when they add different objects to the two sides of the balance.

Exploration should lead children to discover that adding the same thing to both sides does not change the balance.

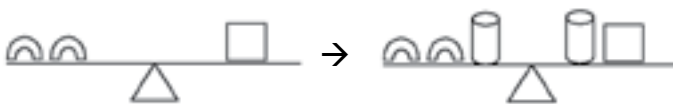

Neither does subtracting the same thing from both sides.

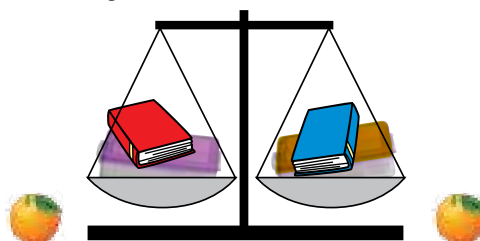

Experience with the balance can also help children develop an understanding of the *transitive property*.

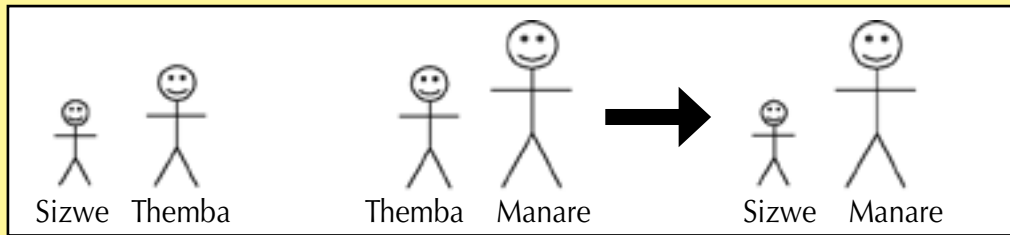

If Themba is bigger than Sizwe, and Manare is bigger than Themba, then Manare is bigger than Sizwe.

### 3b) Capacity

Exploration with capacity also serves both to develop a practical sense of the 'how muchness' of volume and to develop early algebra experiences of equality and inequality. Again give learners plenty of time for free exploration of the capacities of a variety of containers, for example, by pouring their contents from one container to another.

Later, stimulate their thinking with questions such as:

- "If you pour all the water into the other container, what height will it come to?"
- "If you pour all the water into these two containers, so that it comes to the same height in each one, how high will the water in each container be?"
- "If you then pour the water from both containers back into the first one, how high will the water come?"

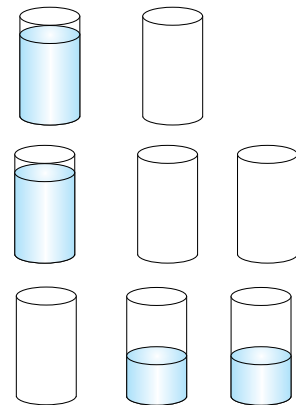

#### Predict:

"How many cupfuls do you have to add to the container on the right for the water to come to the same height as it is in the container on the left? Test your prediction."

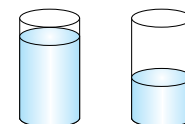

Then return the containers to the way they were at the beginning and say:

"How many cupfuls do you think you must remove from the container on the left for the water to come to the same height as it is in the container on the right? Test your prediction."

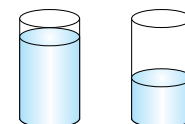



### 3c) Length

#### Which things are bigger?

This activity works best if it's possible to have half the class work in another room while the groups make their measurements.

#### Step 1

Each group needs a set of at least six different objects to measure, and a set of things to use as non-standard units to measure them. The measuring tools should range in size, the smallest being 1 or 2 cm, and the largest 20 or 30 cm. The learners don't know that the objects to be measured are identical, but the tools for measuring them are not.

#### Step 2

Choose six or more objects to measure. These should range in size from a few centimetres to more than a metre.

#### Step 3

Tell the class that they are going to measure the objects with a variety of informal units. The goal is to find out, when the two teams share their results, which group has the larger size of each item. Each half of the class will be working cooperatively. Within each team, learners will help each other to make sure all the measurements are done correctly, and later they will see which team did a better job of measuring.

#### Step 4

Within the groups, learners should work in pairs. The group should divide up the tasks so that every item is measured with each set of units at least twice. If there is a big difference in the measurements those learners who measured that item should work together to find out why, and to agree on the correct measurement.

#### Step 5

Give each team a set of measuring tools, such as dice, paper clips, pencils and straws. Choose a wide range of sizes so that each unit will be appropriate for measuring one or more of the items, and inappropriate for measuring one or more others. However, if one team gets standard size paper clips, the other team will get jumbo ones; if one team gets small pencils, the other team will get regular pencils; if one team gets whole straws the other team should get straws with a quarter or a third of the length cut off. Team A should get the larger version of at least one of the measuring units, the smaller version of at least one of the units, and at least one of the units should be identical for both teams. Decide whether you want the learners to record whole units only, which makes the activity a little simpler, or estimate half units, which gives them practice with halves.

#### Step 6

Display all the results in a table.

#### Measuring tools

	Measuring tools			
	dice	paper clips	pencils	straws
small block				
book				
umbrella				
pencil sharpener				
scissors				
broom				

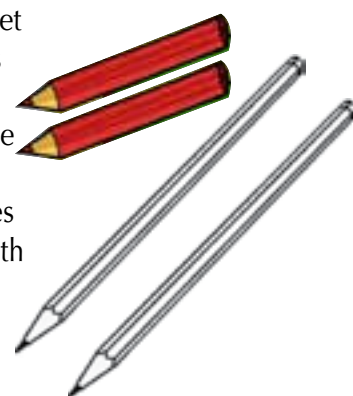

**Step 7**

What patterns do learners see in the results? Accept all answers, but be sure they identify that the smaller the units, the more of them in the measurement. "Which units were most appropriate for measuring the largest item? Why? The smallest?" etc.

**Step 8**

Bring the class together again. Have each team display the table with their results. Now have learners work in groups of 4 – 6. Their task is to put all the larger items in one group and all the smaller items in another according to their results.

Give them plenty of time to discover that it's a trick question. For each item, Team A's measurements compared to Team B's, are the *same* for some units, *larger* for others, and *smaller* for still others. Why? The answer to that question is the 'Big Idea' of this lesson. Learners should realise that the size of their final measurements depend on the size of their unit of measurement. For example, if Team A used whole pencils it will need less pencils to measure the same item than Team B who used "cut-off pencils".

Tell the story of the king who wanted to surprise his queen with a birthday present of a bed.

**A Tall Tale of Two Feet**

Because it was a surprise he waited until she was asleep and measured around her to see how big the bed should be. He measured very carefully, heel to toe and heel to toe. He found that the bed needed to be six feet long and three feet wide.

So he went to a carpenter who was famous for carving beautiful beds and he asked him to make a bed fit for a queen, exactly six feet long and three feet wide.

The king was so excited because he was sure his queen would be delighted with her new bed and would sleep very comfortably on it.

Finally, on the morning of the queen's birthday the carpenter brought the bed. It was the most beautiful carving the king and queen had ever seen. But when she lay down on it, they saw that it was far too small.

The king roared, "I told you to make it six feet long and three feet wide!" "But I did, sire. Look," said the carpenter, and he measured off exactly six of his feet long and three feet wide.



What happened in the story? As an extension, let's invent our own stories about what can happen when we do not use the same sized units to measure.

**4. Standard units for measuring**

It is accepted practice when we introduce measurement to measure length, mass, area, and capacity with a variety of non-standard units before we introduce standard units. We begin with non-standard units:

- firstly, to introduce the idea of measurement informally, and,
- secondly, to help learners see the limitations of non-standard units and so come to understand why we need standard units.

Sooner or later, standard units are needed in order to be able to communicate information about measurement. Here is an activity designed to help learners discover that necessity.



## Grade 2: Measurement

### Length – centimetres, metres and kilometres

When we introduce standard units in Grade 2 we want learners to develop a familiarity with the quantities we use for formal measurement.

- Have learners make their own ruler by cutting out 10 cm strips from cm grid paper. Ten strips together make a metre.
- Review the concept of measuring from the starting point to the end point. If the 0 of the ruler is at the starting point, the length can be read from the number at the end point.
- Have each learner find a number of things that are 1 cm in length, 10 cm and 1 metre.
- Working in pairs, have learners trace their partner's outline onto large paper and have each learner cut out his outline to make a life-sized poster. Have learners find something on their body that is 1 cm, 10 cm and 1 m.
- Find something in your school environment that is 1 kilometre long. For example, if you have a running track, measure it and work out how many laps make 1 kilometre. Or work out how many times around the school yard is a kilometre. You can also find a point along the road exactly 1 km from school or two local landmarks that are exactly 1 km apart. Encourage the learners to walk the 1 km journey to get a sense of how far 1 km is.



### Mass

- Give learners items that are 1 g, 10 g, 100 g and 1 kg in mass. Let them explore and find, by lifting various items, several things of similar mass.
- Have each learner make a poster with one item for each mass. Ask them to choose which item they think of when they want an idea of how much mass is in 1 g, 10 g, 100 g and 1 kg.

### Capacity

- Give learners items that hold 5 ml, 10 ml, 100 ml and a litre. Have them explore, looking for things that have the same capacity. They can estimate the capacity in the cases where it's not possible to measure it.



## 5. Place value games

The introduction of metric units is also an opportunity to deepen the learners' understanding of place value in the base 10 system.

### Units of mass and capacity

Learners play in pairs. They take turns to roll a die. The aim is to reach a sum, after 7 turns, of as close to a target length as possible. For example, they can use 1 g or 10 g to reach a goal of 100 g, or else choose 10 g and 100 g to reach a goal of 1 kg.

To play with volume, choose 1 ml or 10 ml to reach a goal of 100 ml, or else choose 10 ml or 100 ml to reach a goal of 1 litre.



### Estimation

Estimation and prediction are part of almost every measurement activity, whether learners are measuring length, mass or capacity. There are also many opportunities for prediction in activities you do for other subjects.

### Waste Paper

Decide on a place to pile up scrap paper (or other waste material) for a week, then explain:

Record learners' predictions. Measure the height of the pile each day. At the end of the week, compare the results with the prediction.



### Rain Gauge

Make a rain gauge by marking 1 cm intervals on the outside of a clear plastic container. Secure it outside in an open area where it will collect water in the rain. Have learners predict how full the container will be after a week of rain. After a week, pour the water into a measuring cup to see how many millilitres of rain fell. Compare the amount that fell with their predictions.



## Grade 2: Measurement

### 6. Measurement scavenger hunt

Scavenger hunts are fun. The questions can focus on length, mass or capacity.

- **Direct measurement:** find something the same length as a straw, the same mass as a tennis ball, or as heavy as this book.
- **Greater than and less than:** find something longer than a new pencil and shorter than your pencil case; heavier than the sellotape but lighter than the scissors; or that holds more than the cup but less than the flask.
- **Non-standard units:** find something that is 6 paper clips long, the same mass as 3 dice, or something that holds three scoops.
- **Standard units:** find something that is 1 m long; something with a mass of 3 gm, or something that holds 500 ml.

Scavenger hunts can take place inside or outside, and can easily link to other maths outcomes by adding criteria that have to do with number, patterns or shapes. You can also use standard units of measurement.

While the learners are looking and measuring, you'll have the opportunity to observe their understanding of measurement and give guidance where appropriate.

## Vocabulary

### Time:

early	late	day	night	morning	afternoon
evening	before	after	beginning	end	clock
watch	face	hand	later	earlier	sunrise
sunset	shadow	o'clock	clockwise	anti-clockwise	half past
quarter past	quarter to	minutes past	minutes to	fast	slow
today	tomorrow	yesterday	names of days of the week and months of the year.		

### Mass:

heavy	light	heavier	lighter	heaviest	lightest
heavier than	lighter than	more/less	same as	has greater mass	has less mass.

a light object has less mass  
a heavy object has more mass

### Capacity:

full	empty	holds more than	holds less than	half full
the same as	least	most	cups	buckets
jugs glasses	estimate	container.		

### Length:

longer	shorter	taller	higher	as long as	as short as
estimate	high	low	shallow	hand span	foot
pace	centimeter	metre	millimetre.		

## Resources

clock faces without numbers	bags
spinners	feathers
special dice	rocks
grid paper	a scale or balance
scissors	objects for casting shadows
sellotape	torch
aluminum foil	table
water	lamp
sand	pictures relating to time of day
containers of various sizes	pictures relating to holidays of different cultures
beans to plant	picture of the earth from space
plastic or cardboard shapes	constellation maps and star finders
tangrams	information on Islamic, Hindu, Jewish, Chinese calendars
string	holiday dates, timetables, newspapers,
rulers	information on the times of historical events,
blocks or other material to stack and build with	times from local or school sports.
boxes	



The learner will be able to collect, summarise, display and critically analyse data in order to draw conclusions and make predictions, and to interpret and determine chance variation.

## Skills and knowledge

### The learner:

- Collects data (alone and/or as a member of a group or team) in the classroom and school environment to answer questions posed by the teacher (e.g. 'How many learners are there in each classroom?').
- Sorts physical objects according to one attribute chosen by the teacher.
- Gives reasons for collections being grouped in particular ways.
- Draws pictures and constructs pictographs that have a 1-1 correspondence between own data and representations.
- Describes own or a peer's collection of objects, explains how it was sorted, and answers questions about it.

## The data handling process

In Grade 2 learners continue to collect and sort concrete objects and gather data from surveys and experiments. They will collect, sort, analyse and display the data with the help of tables, tallies and pictographs.



The vocabulary that learners need to understand and use for these skills is listed at the end of the suggested activities. You will find it helpful to make flash cards with key vocabulary words to support the teaching and learning process. A list of the resources you will need for the activities is also provided.

## 1. Collecting and sorting activities

### Examples of data that learners could collect

- kinds of footwear children like
- how much different family members weigh
- different lengths of clothes, e.g. scarf, pants, socks, etc.
- cleaning materials used at home
- types of pets
- objects that can float/ sink
- what objects are made of, e.g. wood, glass, plastic, etc.
- favourite colours/ toothpaste/ soap/ fruit/ vegetables/ animals
- ages of family members
- ages of learners in the class
- weather chart: how many sunny/windy/rainy days; temperatures, etc.
- farm animals, wild animals, pets
- ways of transport to school
- birthdays of learners / family
- different kinds of homes
- toys learners have
- reading lists of books learners have read
- different kinds of cars

### Examples of graphs

Transport to school	
	☺☺☺☺☺☺☺☺
	☺☺
	☺☺☺☺

☺ = 1 learner

Fruits in learners' lunchboxes

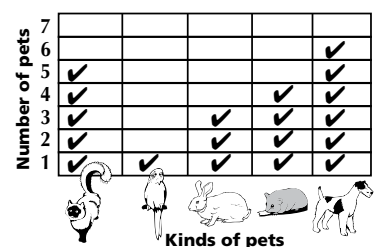
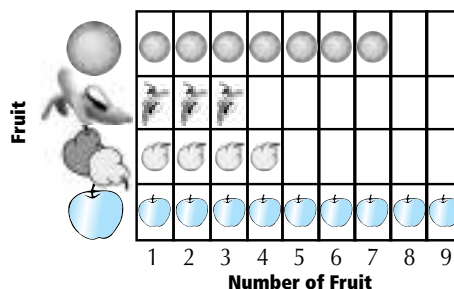

**Possible criteria to sort objects**

**Size:** big/ small; tall/ short; long/ short; fat/ thin; thick/ thin

**Mass/weight/capacity:** heavy/ light; float/sink; full/empty

**Age:** old/ new; old/ young

**Colour:** primary/ secondary colours

**2-D Shape:** triangle, circle, square, rectangle

**3-D object:** boxes, balls, cylinders, objects that can roll or not roll

**Texture:** rough/ smooth; soft/ hard

**Number:** range 0 – 100; multiples of 10, 5 and 2 from 0 - 200

**Speed:** objects that move and don't move; fast/ slow (animals, transport, etc)

**Material:** plastic, leather, glass, paper, wood, steel, etc

**Classification:** transport/ fruit/ toys/ clothes etc

**Similarities/ differences:** sort bag of shapes according to two similarities, e.g. put together all the shapes that are both smooth and thick.

**Summary of the types of data collecting tools used in Grade 2**

**Sorting circles (Venn diagrams)**

When children begin to sort objects, they group the objects together, and may make a line around them with crayon or with string, or make pictures of the objects in groups, and encircle the groups that belong together. Sometimes we give them the attribute they should sort by, and other times they choose it themselves. Although the learners sort groups of objects with many attributes, in the early grades the learners sort only one attribute at a time, and the sets do not overlap (intersect).

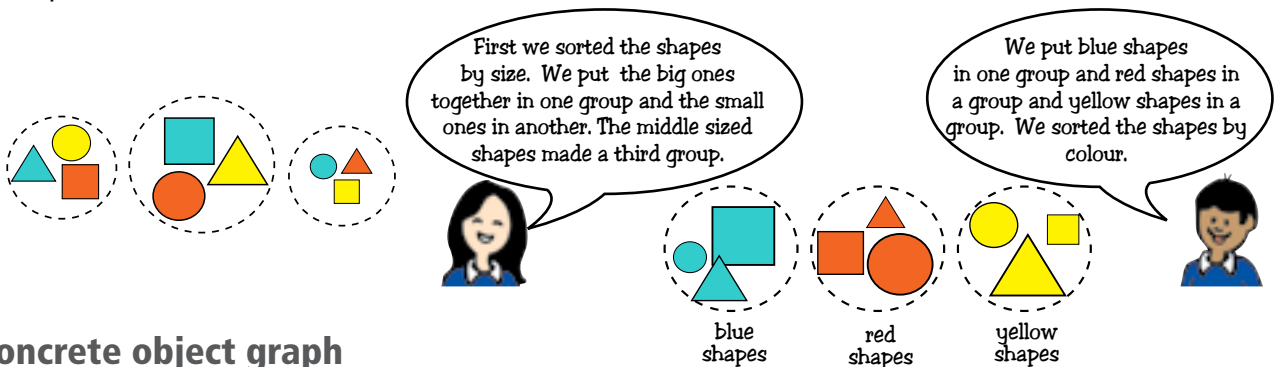

**Concrete object graph**

A concrete object graph involves categories and counts of the number of people or things in a category (frequency). Actual people or things are placed on the floor, desk, or paper to display the categories and counts. The layout of the graph can be in any direction. The layout here is horizontal.

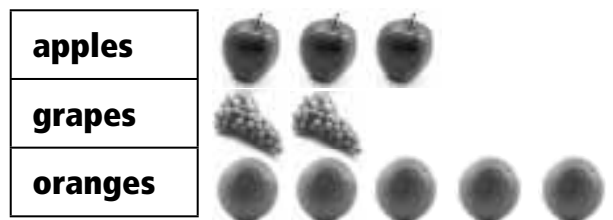

**Pictograph or pictorial graph**

A pictograph or pictorial graph involves categories and counts of the number of people or things in a category (frequency). Drawings or other pictures are used to display the counts in each category. The layout of the graph can be horizontal or vertical. The layout here is horizontal.

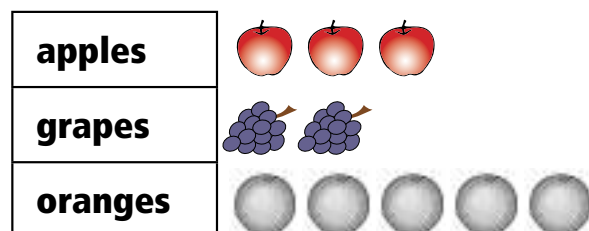

## Grade 2: Data handling

### Symbolic graphs and tallies

A symbolic graph uses some type of symbol (a tick mark, an X, a happy face) to display the count in each category. The layout of the graph can be horizontal or vertical. The layout here is vertical.

	✓	
	✓	
✓	✓	
✓	✓	✓
✓	✓	✓
Kokis	Pencils	Pens

### Ways we get to school

Car	///
Bus	////
Walk	////
Bike	///
Taxi	## II

When we use tally marks grouped by 5, the symbolic chart used is called a tally chart.

### Carroll diagram

Carroll diagrams are rectangular tables that display data in a yes/no way. They are named in honour of Lewis Carroll, the author of *Alice in Wonderland*, who was also a mathematician.

Even	Not Even
2, 4, 6	1, 3, 5, 7

Suppose, for example we have the numbers 1, 2, 3, 4, 5, 6, 7, and we ask if each number is even.

### Lists

A list is a series of related words, numbers, or other items. We use lists everyday - a grocery list, a list of errands, letters to write or calls to make. A list may or may not be numbered, or organised in some logical way, and it may or may not be displayed with lines, rows, columns, etc. We could ask each classmate how he or she got to school today, and make a list of the answers as we receive them.

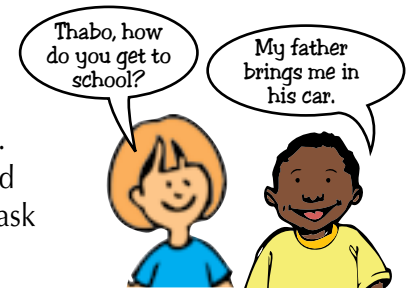

### Tables

If we have a lot of data in a list that isn't organised, it's not easy to summarise it at a glance. Often we can see patterns in the data more easily if, as we collect the information, we record it in a table. A table has rows and columns for the information. The grid lines may or may not be displayed. Spreadsheets used in computing are examples of tables.

If we know that all the learners travel to school either by bus, car, bicycle, walking, or taxi, we can make a table with the means of transport across the top. Then, when we learn how a particular learner arrived that day, we can record his or her name in the right column.

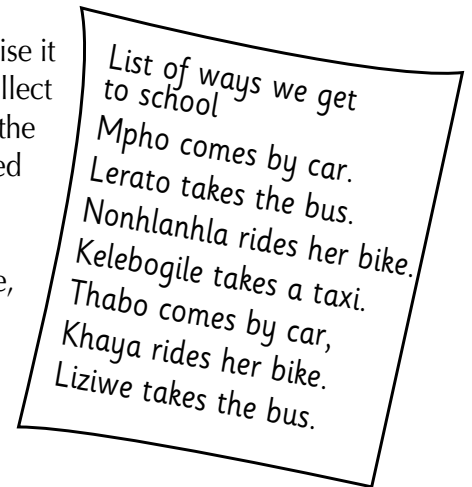

This is a good way to record the data if we want to know not only how many learners arrived by each method, but also who came to school with which transport.

We often use tables to record data when we are conducting experiments.

### Ways we get to school

Car	Bus	Walk	Bike	Taxi
Mpho	Lerato	Paul	Karabo	David
Thabo	Lesedi	William	Nonhlanhla	Steven
Mary	Liziwe	Ngubo	Khaya	Kelebogile
	Elsie	Queenie		Zami
	Manare			Luna
				Heather
				Ayanda

## Suggested activities

### Sorting people

To help learners develop the skills they will need to organise and classify data in tables and charts, challenge them to work concretely to sort themselves according to various criteria. For example, ask them how they can find out whose birthdays come before and after their own. Ask them to organise themselves in some way according to their birthdays. You may like to do this activity outside. Don't worry if the process is a little chaotic. Let them think and experiment. Eventually they will end up in a circle, or find some other creative way to answer the question.

Try other ways of sorting the class. Ask one learner to sort the class according to a secret rule of their own choosing. You can model the activity for them. Choose, for example, to put all the learners wearing jerseys in one group, all the learners wearing tracksuit tops in another, and those not wearing either in the third.

Send the learners to the appropriate groups one by one. Ask learners to tell you when they think they have guessed the rule. Rather than have them say the rule, let them assign the next learner. If the assignment is incorrect, make the correct assignment and then ask for another volunteer. If it's right, have them continue to make assignments until you're sure they know the rule, then ask for another volunteer. Once you've modelled the game, let learners take turns deciding on the rule. This game is a lot of fun and can be played frequently.

### Class shop

Set up a class shop. Give each learner R100 in play money. Use items to represent the things learners will buy. Have each learner make a poster advert for a product of his or her choice. Let them have special offers on the price, such as "R4 each, or 3 for R10". Let learners take turns to be shopkeepers and customers. Have the customer buy at least 3 items. Let the class check to see if they have summed the prices correctly and have given the right change. Make a table for each learner to keep track of his purchases.

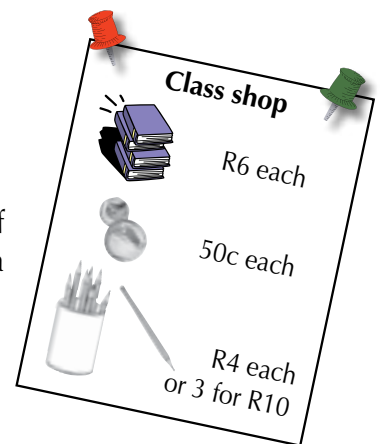

Date	Item Purchased	Amount	Balance
1 June 2009	Starting Balance		100
2 June 2009	1 Chocolate Ice Cream Cone	R5	95

### Symmetry

Make cards with pictures of cultural artefacts such as baskets or beads and have learners sort them according to the type of symmetry they see.



### Carroll diagram

Give the learners lists of numbers or things and have them use Carroll diagrams to answer questions such as:

"Is it an odd number? Is it a bird? Is it green?  
Is it food? Does it roll?"

Even	Not Even
2, 4, 6	1, 3, 5, 7



## Grade 2: Data handling

You can also use a Carroll diagram when introducing a concept by giving examples and counter examples, and have learners sort shapes and objects such as balls and not balls, boxes and not boxes, squares and not squares.

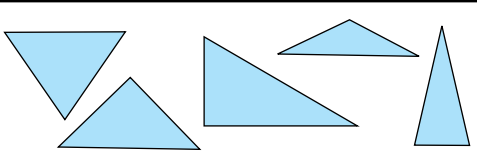
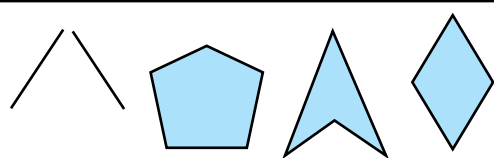
These shapes are triangles	These shapes are not triangles
	

## Making graphs

### Estimation with mixed beans

Make a mixture of different kinds of beans and put them in a big bowl. Ask the learners to estimate how many beans they can hold in a closed hand so that no beans are showing. Have them write their estimate down and show you their estimate. Taking into account the range of estimates, choose appropriate intervals for guesses. For instance, you might choose intervals of 0-10, 11-20, 21-30, etc. up to the maximum amount of your learners' estimates. Put signs indicating the intervals on the front of your desk. Give learners something that can stack, such as blocks or books, and have each learner put the object in the appropriate stack, to make a concrete graph of the distribution of guesses.

Then let each learner take a handful of beans. The other learners can help them make sure that no beans are showing. Have each learner count his or her beans. Let them remake the concrete graph according to their counts.

Repeat the experiment (this could happen on a different day), but this time, choose a different container to hold the beans – small cups, for example. Again have everyone estimate, make a concrete graph of their estimates, and then have everyone do the experiment. Again, compare the result of the experiment with their estimates.

### Extensions:

Do a similar activity with estimations of length, mass and capacity using non-standard units. Let learners guess first, then have some measurement experiences, then estimate again. Be sure to let them see how their estimation skills improve after some experience. See LO4 for many measurement activities.

### Growing beans

Plant the beans in soil and watch them grow. Have learners measure the height of the beans with string and attach the string to a table with the date. Check and record the height over a few weeks. Have the learners make pictographs of the growth of their plants.

For the simplest experiment, have all the learners plant the same kind of bean. Extensions would be to compare different kinds of beans, or to think about what a bean needs to grow – water, lights, nutrients. Some beans could be kept in the shade and their growth compared with the ones in the sun. Or beans could be given different amounts of water.

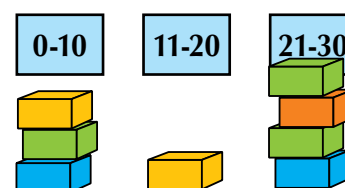



### Half a Heart

You will need: Paper (A4) and scissors.

Tell the learners to fold their papers in half carefully.

On the board, draw a dashed line and tell them it represents the fold of their paper. Then draw half a heart. Tell them to draw a shape like that and cut it out to make a nice heart shape. You could choose a different symmetrical shape. You have purposefully not told them how big to draw their heart, or shown the edge of the paper. The learners will make hearts in a variety of sizes.

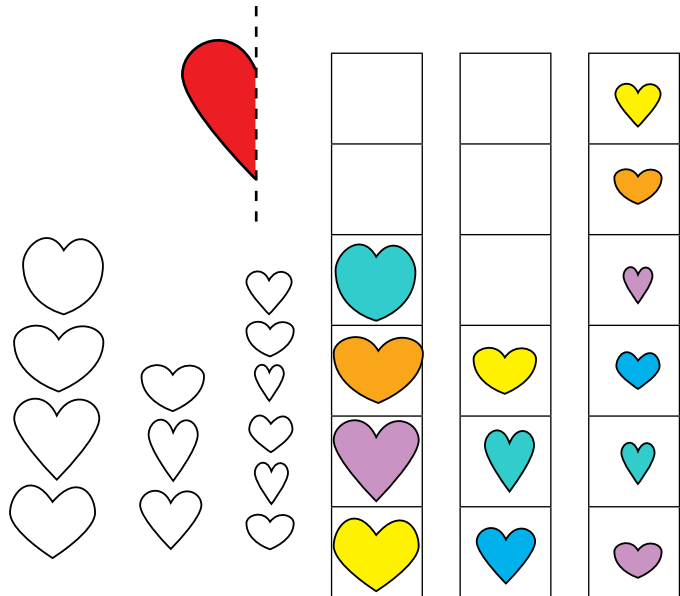

Collect all the hearts and group them into small, medium and large.

Then make a pictograph with the hearts. Discuss the symmetry and the variety of shapes, which are all hearts (or whatever other shape you chose.)

Ask, "Which size heart was made by the most learners?"

To distinguish between the column with the greatest number of hearts, and the column which may be taller because the hearts themselves are taller, you need to put each heart in a box, and make all the boxes the same size.

### Chance and probability

To develop their intuition about chance and probability that they will encounter in Intermediate Phase, learners need a lot of experience with dice, spinners and coin flipping. Use games of chance to strengthen their understanding of numbers.

#### Place value game

This game is a way to deepen the learners' understanding of place value. Give them play money – 5 cent coins and 10 cent coins. The learners play in pairs. Each player needs a score sheet that looks like this.

	10 cents	5 cents
1		
2		
3		
4		
5		
6		
7		

The players take turns rolling the die. Both players use the number thrown.

Each player may take that number of coins – either all 5 cent coins or all 10 cent coins. No mixing is allowed. The player puts the coins in the appropriate column. Whenever a player has ten cents he must exchange the coins for a 10 cent coin, which goes in the 10 cent column. The goal is to have a sum, after exactly 7 turns, as close as possible to R1. After 7 turns the players look to see who is closest. That player is the winner.

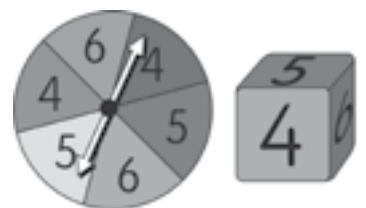

#### Extensions:

- Make a rule that the winner is the one who is closest to R1 without going over.
- Play with three columns, with 5 cent, 10 cent and R1 coins, with a goal of getting as close to R10 as possible.
- Instead of coins, play with written numerals. On each roll, the player may write the number rolled in either the 1's place or the 10's place. The one whose sum is closest to 100, without going over, is the winner.



## Grade 2: Data handling

### Data handling integrated with time

#### How much sleep do we get?

Learners work alone. Ask each child to write the answer to these questions:

- What time do you usually go to sleep?
- What time do you usually wake up?
- How much sleep do you usually get?

Have the learners write the amount of sleep they get in hours on a slip of paper. As a class, sort them from most to least. Let each learner put his or her slip of paper onto the graph to make a pictograph. This is also a good opportunity to discuss the health benefits of a good night's sleep.



#### Calendar activities

Make a place value display next to the calendar. You need two pockets to hold straws. Each day add 1 straw to the units pocket. On Monday also add straws for each weekend day. When there are 10 straws, bundle them together and put the bundle in the tens pocket. Starting with the bundled straws first, count the straws to find the date.

Add birthdays to the calendar as they occur and use them to complete a birthday chart.

#### Time of day

- As learners master reading an analogue clock, make sets of cards with clocks showing different times. Use one colour for AM times and another colour for PM times. Let them work in pairs to put the time cards in the correct sequence.
- Make picture cards for activities that happen at different times of the day – going to bed, eating meals, brushing teeth, going to school, studying in class, playing, classroom chores, going home, etc. Let them match the clock cards to the activity cards.
- Let them sequence the activity cards without the clocks.
- Display the classroom schedule showing the time of each activity and a picture of what happens at that time.

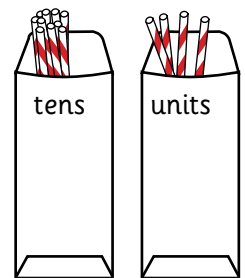

#### Weather

Discuss the weather each day. Let a different learner put a picture on the calendar each day showing the weather that day. At the end of the month make a graph to see how often which kind of weather occurred.

#### Weather Chart for April

Monday	Tuesday	Wednesday	Thursday	Friday	Saturday	Sunday
		1 ☁	2 ☁	3 ☁	4 ☀	5 ☀
6 ☀	7 ☀	8 ☀	9 ☀	10 ⚡	11 ☁	12 ☁
13 ☀	14 ☀	15 ☁	16 ☁	17 ☁	18 ☀	19 ☁
20 ☁	21 ☁	22 ☁	23 ☁	24 ☀	25 ☀	26 ☀
27 ☀	28 ☀	29 ☁	30 ☀			

#### Weather graph for April (symbolic graph)

☀	✓	✓	✓	✓	✓	✓	✓	✓	✓	
☁	✓	✓	✓	✓						
☁	✓	✓	✓	✓	✓	✓	✓	✓		
☁	✓	✓	✓	✓						
⚡	✓									
❄										

Ask questions about the graph, e.g. "How many sunny and partly sunny days did we have in April?"

Use the graph to look for patterns in the weather.

## Vocabulary

If you do not teach in English, use equivalents in your language of instruction.

### Grade 1:

- collect, sort, classify, arrange, compare, order
- graph, pictograph

### Grade 2 - add the following to the Grade 1 vocabulary:

- tally, list, diagram, Carroll diagram, symbol, table

### Grade 3 - add the following to the Grade 1 and 2 vocabulary:

- column, row, bar graph, scale.

## Resources

### Grade 1:

- things that learners can collect and sort
- daily programme, birthday graph
- measuring tools such as arms, feet, hand spans, bottles, buckets, spoons, balances (scales)
- sorting circles (Venn diagrams), concrete graph, pictograph, number line.

### Additional resources for Grade 2 and 3:

- clocks, calendars with important dates, weather chart
- extra measuring tools for distance around a shape and for area such as string and tiles.
- tally sheets, Carroll diagram, lists, tables, bar graph.

# Grade 3: Numbers, operations and relationships

The learner will be able to recognise, describe and represent numbers and their relationships, and to count, estimate, calculate and check with competence and confidence in solving problems.

## Skills and knowledge

### The learner:

- Counts forwards and backwards in:
  - a) the intervals specified in: Grade 2 with increased number ranges;
  - b) twenties, twenty-fives, fifties and hundreds between 0 and at least 1 000.
- Knows, reads and writes number symbols and names from 1 to at least 1 000.
- Orders, describes and compares whole numbers to at least 3-digit numbers
- Recognises the place value of digits in whole numbers to at least 3-digit numbers.
- Uses the following techniques:
  - a) building up and breaking down numbers;
  - b) doubling and halving;
  - c) number lines;
  - d) rounding off in tens.

The vocabulary that learners need to understand and use for these skills is listed at the end of the suggested activities. You will find it helpful to make flash cards with key vocabulary words to support the teaching and learning process. A list of the resources you will need for the activities is also provided.

## Suggested activities

In order to help learners develop a good understanding of our counting system, integrate counting activities with sequencing (ordering), comparing, naming and describing, grouping into multiples, number patterning and place value work.

By Grade 3, learners should be developing the ability to work abstractly and also to extend their understanding of counting patterns to bigger numbers (up to 1 000) and with bigger multiples (twenties, twenty-fives, fifties and hundreds). However, where necessary, support learning with appropriate concrete aids. Continue to use concrete materials to:

- introduce new concepts;
- work with bigger numbers and new multiples;
- support learners who are not yet secure with Grade 1 and/or 2 counting and sequencing.

### 1. Counting and ordering numbers

Start by checking that learners are able to meet the Grade 2 requirements and that they can build on this knowledge.

## Counting in 2s, 5s and 10s

Check that learners can count efficiently in multiples of two, five and ten.

Let learners count objects in drawings that have been grouped in different ways.

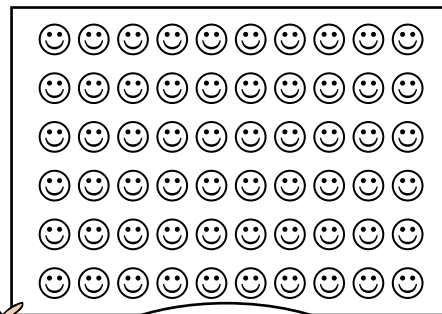
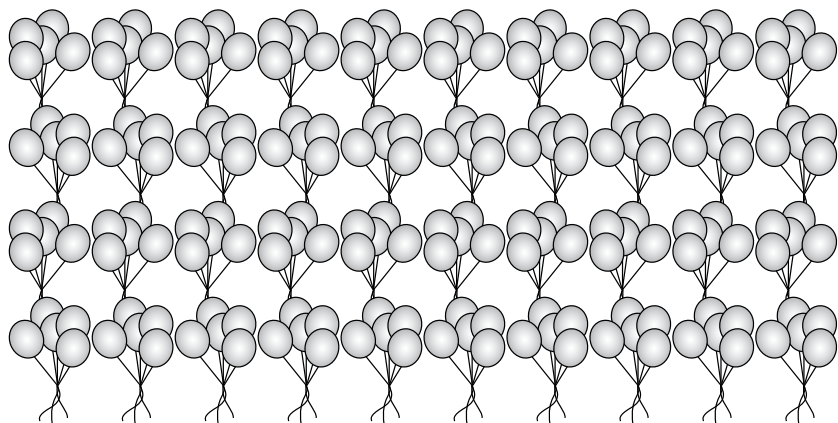

How many mouths do these children have altogether? ... How many eyes? ... ears? ... fingers? ... toes? ... fingers plus toes? ...

See Resources, p367, for example worksheet.

## Counting backwards and forwards

- Ask questions to check that learners can count backwards. For example, "One bunch of balloons flies away. How many balloons are left? ... 2 bunches fly away, how many are left? ... 3, 4, 5 bunches fly away ... how many are left? ... I have 100 balloons left. How many bunches flew away?"
- Encourage learners who can count accurately, to extend their counting patterns to larger numbers by asking questions like: "I have 150 balloons. I buy one more balloon. How many balloons do you think I have now? ... I buy 2 more balloons, how many now? ... 3 more? ... 4 more? ... a whole bunch more? ... 2, 3, 4, bunches more?", etc.

## Organising objects

Check that learners understand the purpose of organising objects to count in multiples.

## Estimate and count

One learner puts out a large handful of objects (e.g. beans, stones, counters) on the table. Each group member writes down his/her estimate of the number of objects. As quickly and accurately as possible, the group counts and checks the actual number of objects. The group winner is the learner who makes the closest estimate. Encourage groups to find ways to group their objects for quick, accurate counting and checking.

I notice these two groups counted very quickly. How did you manage that? How do you know that you counted accurately?



We made groups of 5. It's easy to count and check... 5, 10, 15, 20, 25, 30, 35, 40, 45, 50, 55, 60, 65, 70, 75, 80, 85 ... add the 2 extra ones...that's 87 altogether.

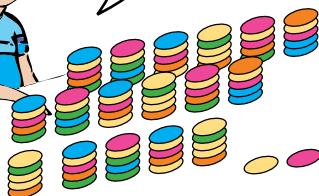

We grouped in 10s...10, 20, 30, 40, 50, 60, 70, 80 and these 7...that's 87 altogether.

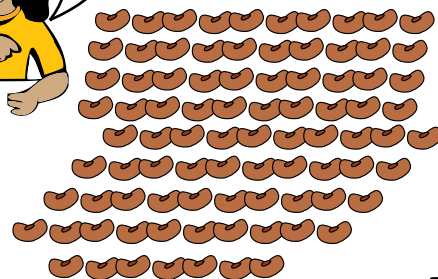

## Grade 3: Numbers, operations and relationships

Extend the game by encouraging learners to organise their groups into bigger multiples. Ask questions like: "How many groups of five make a group of ten? ... How many groups of ten make a group of twenty? ... Can you group your objects in twenties? ... Now see how quickly you can count them in twenties?"

### Counting by grouping

Learners can practise counting in twenties by taking bigger handfuls of objects, organising them into groups of twenty and then counting them as quickly as possible. Let learners who still need to count in fives or tens do so. With more experience, through counting and organising different amounts into larger groups, they will develop the understanding and the confidence to count more quickly.

Set challenges that encourage learners to think about the patterns for counting in multiples of twenty... "If you have 20 objects, how many groups of 20 do you think you will be able to put out? Do you think you will have any objects left over? ... If you have 21 objects, how many groups of 20 do you think you will be able to put out? Do you think you will have any objects left over? ... 40 objects? ...47? ... 50? ... 60... 63?" etc.

Extend the activity further by encouraging learners to organise their objects into groups of twenty-five and, later, groups of fifty. Ask guiding questions to help learners think about the patterns for counting in each of these multiples.

### Counting money

Use play money as a resource to help learners count in multiples of twenty, twenty-five, fifty and a hundred. Once learners are familiar with the values of your local money and can convert between denominations, you can let them play estimating and counting games with play money. For example:

In this document we use examples of South African money. Substitute examples of your local money as appropriate.

- Let learners investigate the similarities and differences between counting in tens and counting in hundreds by making amounts up to R1 000 using their R10 and their R100 play notes.

"Make R100 with your R10 notes. How many R10 notes did you use?"

Stack them in a pile. Make enough piles to show R500."

"Make R500 with your R100 notes. How many did you use?"

"Make piles of R10 notes to show R800. Now make R800 with your R100 notes.

Show R1 000 using your R100 notes. Show R1 000 by making piles of R10 notes."

"How many R100s do you think you need to make R2 000? How many R10 notes to make R2 000?"

- Let members of small groups each take a handful of different notes. They estimate the total value of the group's money and then find quick ways to check their estimates.



We counted the money in each pile then we added it like this ... First we counted all the hundreds from all the piles. That's R100 plus R100 plus R200 plus R400 ...makes altogether R800.



Then we added the rest of the money - 75 plus 20 makes... 75, 85, 95 plus another 50 ... We did it like this ... 95 plus 5 is 100 and another 45 makes 145. In the end we added 800 plus 145. That's R945 altogether. Whew we did a good, long job!



## Grade 3: Numbers, operations and relationships

- Once learners have worked practically with their play money, give them written exercises, like these:

Ask them to look for patterns in their answers and to tell you about these.

Extension

$2 \times R10 = R?$   
 $20 \times R10 = R?$   
 $7 \times R10 = R?$   
 $70 \times R10 = R?$

$1 \times R100 = R?$   
 $2 \times R100 = R?$   
 $20 \times R100 = R?$   
 $7 \times R100 = R?$



I notice that  
 $20 \times R10$  gives the same answer  
as  $2 \times R100$  and that  $7 \times R100$  is  
the same as  $70 \times R10$ !

### Exchanging money

Let learners practice exchanging money by playing the *Trader's Game*.

Make game boards on A4 paper or cardboard.

#### Rules

One learner is the banker. The banker controls the money and checks the exchanges. The rest of the players take turns to throw the dice. The number that the dice lands on shows how many 10c pieces the banker must give that player. The player puts the 10c pieces in the last column on the board.

Learners continue to take turns. After each turn they add their 10c coins.

When a player gets more than ten 10c pieces, he or she must exchange these for a R1 coin.

When they have more than ten R1 coins, they exchange them for a R10 note.

Depending on the amount of playing time available, the winner can be the first one to make R10, R20 or R100.

You can extend the game by changing the rules and the game boards in different ways to encourage learners to build up and count in bigger multiples.

For example, let the number the dice lands on show how many R5 notes the banker must give each player, and use a board like this:

Trader's Game		
R10	R1	10c

R100	R50	R20	R10	R5

### Comparing amounts

Check that learners can compare amounts and have developed appropriate vocabulary to describe their comparisons.

Check that your learners have developed and can use words to describe comparisons in many different situations, e.g. more, less, fewer, as much as, a little, a lot, same, different, equal, about, nearly – or equivalents in home languages. For example, learners:

- Measure and compare different standard measures, e.g. "Which container holds the most? Which weighs more?";
- Find the relative positions of numbers on a number line, e.g. Show me where you will place these numbers on your number line: 15, 55, 13, 31  
Place these numbers on your number line: 150, 105, 115, 151 or  
Name the twentieth number on your number line;
- Order number cards of different values up to 200.
- Fill in the missing numbers in number patterns,  
e.g. 80; 85; \_\_\_; \_\_\_; \_\_\_; 105, or 140; 130; 120; \_\_\_; \_\_\_; \_\_\_;
- Play *What number am I thinking of?*  
What number am I thinking of? It is more than 67, less than 72 and it is also a multiple of 10.



## Grade 3: Numbers, operations and relationships

- Round off in tens,  
e.g. Is 37 closer to 30 or to 40? ... Is 137 closer to 130 or to 140?
- Compare and order **ordinal numbers**,  
e.g. Who will stand closer to the front of the queue, the person in the fifty-fifth place or the person in the forty-ninth place?  
Place these people from front to back in a queue, the person in the hundred and thirty-ninth place, the person in the thirty-ninth place, the person in the ninety-third place (or equivalents in home language).

Make cardboard cut-outs of number cards for each of your learners.  
(See Resources, p344).

### 2. Building two-digit and three-digit numbers

Extend learners' ability to combine different values and to use place value to read and write numbers up to at least 1 000.

#### Number cards

Extend the Grade 1 and 2 activities with number cards.

If your learners have not used these cards previously, teach them how to arrange their cards in order, how to replace each card in its correct place after they have used it and how to hold the cards correctly when they combine them to make one number (see Grade 1 and 2 work with number cards).

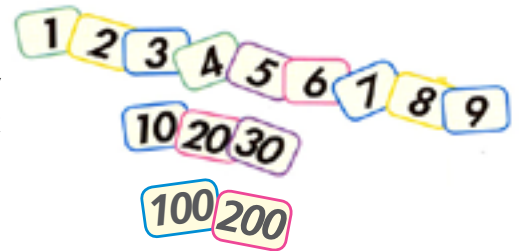

Extend the Grade 2 number card activities by introducing the 3-digit cards. Challenge learners to generalise their understanding of place value patterns to include larger numbers. Include examples where the same digit appears in different places and examples that include 0 as a placeholder.

Hold up your 9 card. Now put it back in the correct place... Show me your 40 card. Now put it back in the correct place... Show me your 100 card. Now put it back in the correct place... How do you think you can make 149 with your cards?

Learners can then work in pairs or small groups. They challenge each other to find and explain ways to build different 3-digit numbers. Let them write the numbers in parts, and as single numbers, e.g.  $400 + 20 + 6 = 426$ .

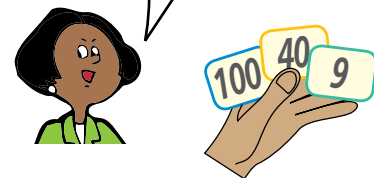

Important note: During the early years it is not useful or necessary to teach place value by getting learners to write  $126 = 1H + 2T + 6U$ . This way of thinking is very abstract and does not come naturally to young learners. It often prevents them from understanding the patterns in our number system and how we use these patterns to break down and build up numbers in ways that help us find ways to calculate and to solve problems. Young learners understand and can use the concept of 'one hundred plus twenty plus six' ( $100 + 20 + 6$ ) more easily because this way of thinking matches the way they read numbers.

Through the activities you present and the guiding questions you ask, learners should develop these important ideas about how our number system works:

- Up to nine, we use a new digit and a new number name for each number (1, 2, 3, 4, 5, 6, 7, 8, 9);
- After nine we begin to group in tens, and in multiples of ten;
- We then place digits in different positions in numbers to show their values.

Each digit in a number has its own value. The place where we write the digit in the number shows its value:

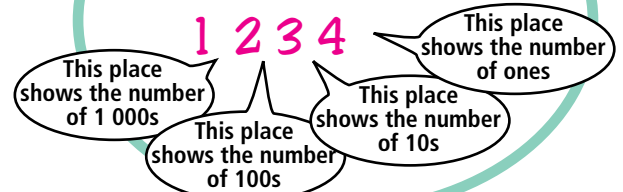

## Grade 3: Numbers, operations and relationships

When we write the number 159, for example, the place of the 1 shows that it stands for 100, the place that we write the 5 in shows that it stands for 50 and the place we write 9 in shows that it stands for 9 'singles' or ones.

We use a zero to show places in the number where there are no values. For example:

**70** the place of the zero shows that there are no ones in this number

**709** the place of the zero shows that there are no tens in this number

Our main aims in getting learners to break down and build up numbers into hundreds, tens and units are to help them:

- understand how we use placing patterns to write multi-digit numbers;
- understand the 'short cuts' we use to write numbers like 78 (we put the 8 for the 'ones' in the place of the zero 'place holder' in the 70);
- understand that in a number like 249, the '2' shows a bigger value than the 9 because of its place in the number - the '2' stands for 200 and the '9' stands for 9;
- understand how they can combine and break up numbers to make it easier to calculate in different ways.



### Find the missing card

To reinforce learners' understanding of how we build up and break down numbers in multiples of 10 and of 100, play the **Find the missing card game**.

Draw a grid like this on the chalkboard (add extra rows at the bottom). Let pairs of learners copy the grid. They take turns to write a 3-digit number of their choice in the first column and to put out either a hundreds, a tens or a ones card in the middle column. Their partner must find the correct two cards and place them in the last column. Learners check each other's solutions.

My Number	Card I have	Cards I need
328	20	
734	4	

Let learners use spinners and number cards to practise building up and breaking down 3-digit numbers into hundreds, tens and units.

In small groups, learners take turns to spin the three spinners. They use number cards to build their numbers and then write their numbers in their books in two ways like this:

$$300 + 40 + 7$$

$$347$$

For each round, the winner is the player who spins the biggest number. Integrate the activity with calculating by letting learners record their scores in a table and write the name or initial of the winner for each round. After about 3 or 4 rounds, let them each total all their scores and then order their totals to find the overall winner. They can also work out how much more the winner scored than each of the other players, or how much less each player scored than each of the other players.

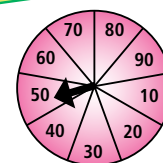

See Resources, p349, for examples to copy.

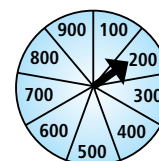
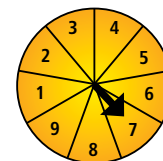

	1st	2nd	3rd
Mary	322	147	765
Luke	189	274	823
Thabo	719	215	386
Nasif	461	227	693

## Grade 3: Numbers, operations and relationships

### Scatter Boards

- Draw, or let learners draw, a scatter board like this for each group of learners.
- Each learner takes 10 counters. They take turns to close their eyes and scatter their counters onto the board. They work out and write down their scores. If a counter lands on a line they use the value inside the line.

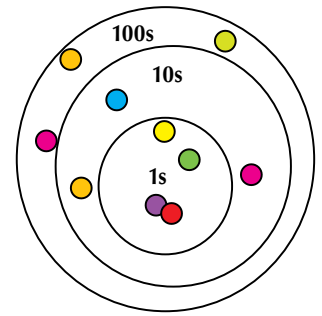

By presenting learners with similar challenging tasks and questions in different contexts and with different aids, you help them build up, practise and reinforce their number knowledge. There is then no need for rote counting and rote repetition of number bonds.

See Resources, p347, for example to copy.

### Writing numbers

Once learners understand how to build the numbers, let them start writing them (they may need to copy from their constructed number cards in the beginning). Develop work cards and worksheets like these, or select appropriate ones from text books so that learners can practise analysing and writing numbers up to 1 000.

<b>Underline all the 70s. Circle all the 5s.</b>							
567	575	758	587	2 697	357	375	573
<b>Write these as numbers.</b>							
nine hundred and two				ninety two			
five hundred and thirty four				five hundred and forty three			
one thousand nine hundred				one thousand one hundred and fifty four			
<b>Break these numbers into hundreds, tens and ones.</b>							
459 = 400 + 50 + 9		210 =					
703 =		739 =					
901 =		910 =					
<b>Build these amounts into one number.</b>							
900 + 40 =		900 + 4 =		900 + 40 + 4 =			
700 + 3 =		700 + 30 =		700 + 30 + 1 =			
<b>Arrange these numbers from the biggest to the smallest.</b>							
700	790	709	79	719			
99	403	800	409	390			
<b>Arrange these numbers from the smallest to the biggest.</b>							
700	790	709	79	710			
99	403	800	409	390			

### Breaking down and building up

Let learners use a variety of formats to practise breaking numbers down and building them up in different ways to show their understanding of place value.

Let learners find the missing outer numbers or add the outer numbers to find the total around different shapes. Let them discuss different ways to do this. Link these formats to the 'empty box' format for writing number sentences.

100 + 100 +  = 250

100 + 25 +  = 250

25 + 25 + 25 + 25 + 25 + 25 +  +  = 200

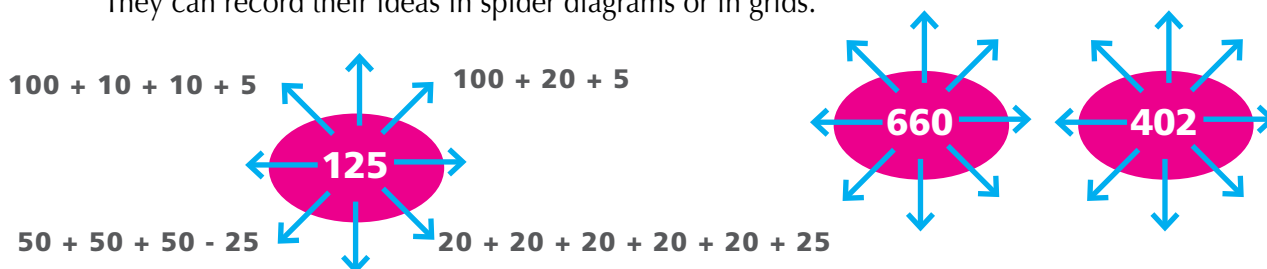

## Grade 3: Numbers, operations and relationships

Let learners find as many different ways as they can to break a number down. They can record their ideas in spider diagrams or in grids.



### Place value problems



Also challenge learners to use their understanding of place value to solve interesting problems. For example, let learners count drawings and exchange them for given values.

In these drawings:  = 100  = 10  = 1

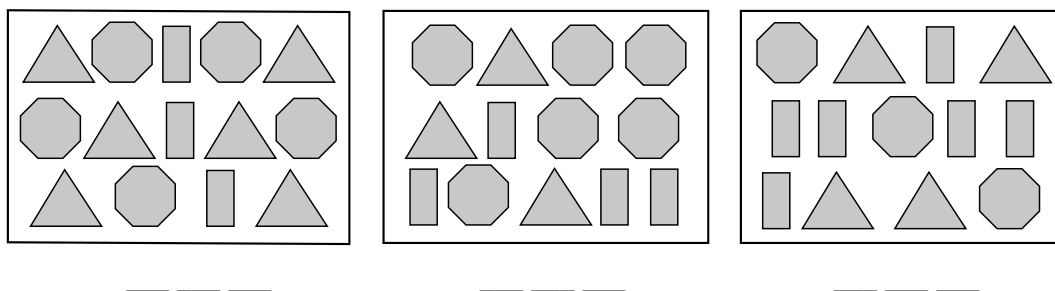
Work out the number for each box of shapes.



(See Resources, p 366)

- Write your three numbers from smallest to biggest.
- Make your own boxes with different numbers of   and .
- Let your friends write the correct numbers under each box and write the numbers in order from smallest to biggest and from biggest to smallest.

### 3. Counting and ordering bigger numbers

Use Number Boards and Number Charts to help learners build understanding of how to pattern, sequence and count forwards and backwards to at least 1 000 in multiples of twenty, twenty-five, fifty and a hundred.

- If your learners have not previously worked with number boards, use and extend some of the counting forwards and backwards activities suggested for Grade 1 and Grade 2 in this document.
- Check that learners can find the positions of numbers up to 200 on the boards. Ask questions that help learners to see how they can *generalise their knowledge* of the counting patterns from 0 to 200 to numbers up to 1 000. Focus on making sure that learners understand that the next number after 200 is 201, that the next number after 300 is 301, that the next number after 400 is 401, and so on. (Many learners, who have not had sufficient practical counting and patterning experience, think that 300 is the next number after 200, 400 is the next number after 300, etc).

Make copies of the appropriate Number Boards for your learners. (See Resources, p360-365).

# Grade 3: Numbers, operations and relationships

c) Then work slowly and systematically on a series of number board activities to help learners use their patterning skills to sequence, recognise and read the symbols for all the numbers up to at least 1 000. Use both blank and numbered boards, and number cards.

Help learners build bigger and bigger numbers by adding blank number boards.

We go on counting from 200 on to the next blank board. What do you think is the first number on the next blank board?... and the next ... and the next?

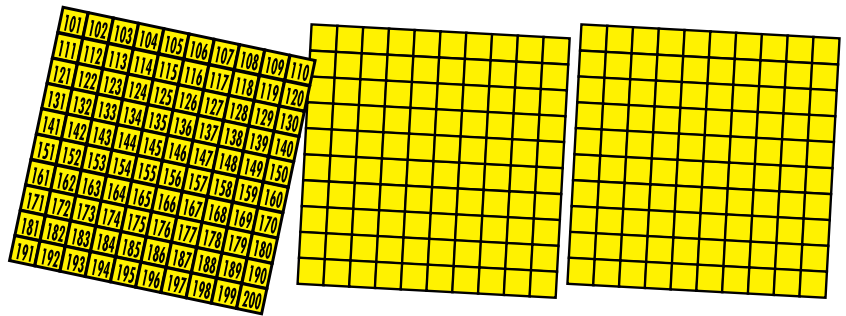
What numbers do you think are under the counters? Why do you say so? Put out your number cards to show all the numbers.

To make 943, I put together 900 plus 40 plus 3. I put each number in its correct place.

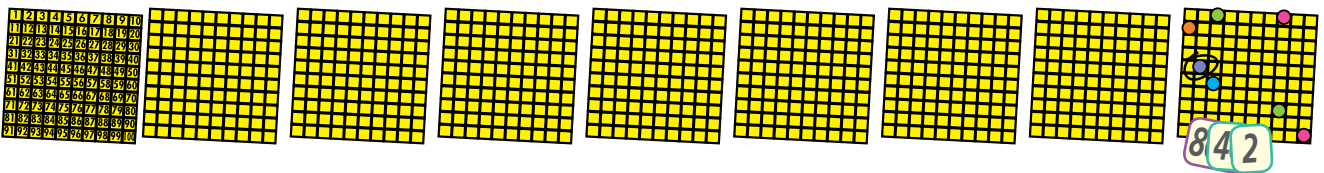
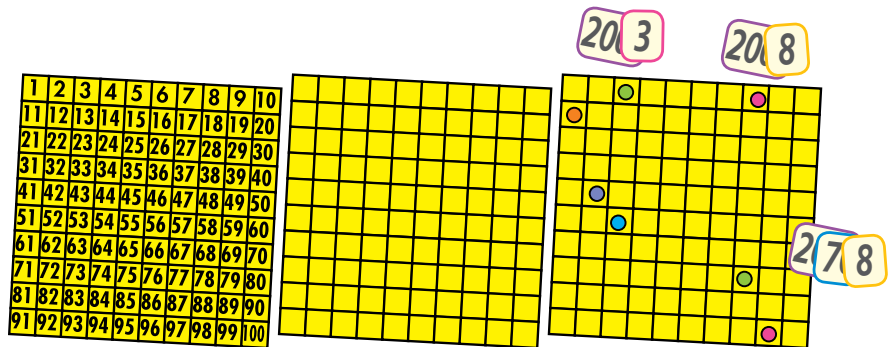

9 4 3

If you find that some of your learners have difficulty in finding and checking the positions for the numbers, let their peers demonstrate and explain their solution methods and ideas.

- d) Learners can then work in pairs to challenge each other to predict where they will land as they move forwards or backwards by different amounts from various positions on their boards.
- e) Let learners write, compare and practise sequencing big numbers in grids.

Find the place on your number boards for 310. If you jump forward 10, where do you think you will land?

Ten count on 10 gets me to 20. So, I think 310 count on 10 will get me to 320. Let me check on our number boards.



Number	Number name in words	Number before	Next number	2 more	2 less	3 more
513	Five hundred and thirteen	512	514	515	511	516



## Grade 3: Numbers, operations and relationships

- f) Develop appropriate work cards and worksheets, or use work from text books to help learners practise using the patterns for sequencing numbers up to at least 1 000. For example:

$$\begin{array}{l} 99 + 1 = \\ 99 + 2 = \\ 99 + 3 = \\ 99 + 4 = \\ 99 + 5 = \\ 99 + 6 = \\ 99 + 7 = \\ 99 + 8 = \\ 99 + 9 = \\ 99 + 10 = \end{array}$$

$$\begin{array}{l} 199 + 1 = \\ 199 + 2 = \\ 199 + 3 = \\ 199 + 4 = \\ 199 + 5 = \\ 199 + 6 = \\ 199 + 7 = \\ 199 + 8 = \\ 199 + 9 = \\ 199 + 10 = \end{array}$$

$$\begin{array}{l} 299 + 1 = \\ 299 + 2 = \\ 299 + 3 = \\ 299 + 4 = \\ 299 + 5 = \\ 299 + 6 = \\ 299 + 7 = \\ 299 + 8 = \\ 299 + 9 = \\ 299 + 10 = \end{array}$$

$$\begin{array}{l} 699 + 1 = \\ 699 + 2 = \\ 699 + 3 = \\ 699 + 4 = \\ 699 + 5 = \\ 699 + 6 = \\ 699 + 7 = \\ 699 + 8 = \\ 699 + 9 = \\ 699 + 10 = \end{array}$$

$$\begin{array}{l} 701 - 1 = \\ 701 - 2 = \\ 701 - 3 = \\ 901 - 4 = \\ 601 - 5 = \\ 801 - 6 = \\ 201 - 7 = \\ 301 - 8 = \\ 601 - 9 = \\ 501 - 10 = \end{array}$$

Continue the pattern. Write the missing numbers.

$$1\ 000 \quad \boxed{-10} \rightarrow 990 \quad \boxed{-10} \rightarrow \underline{\quad} \quad \boxed{-10} \rightarrow 970$$

$$725 \quad \boxed{-25} \rightarrow \underline{\quad} \quad \boxed{-25} \rightarrow \underline{\quad} \quad \boxed{-25} \rightarrow \underline{\quad}$$

Tammy's counter counts the number of people going to a soccer match. What will the counter read when **one more** person goes in?

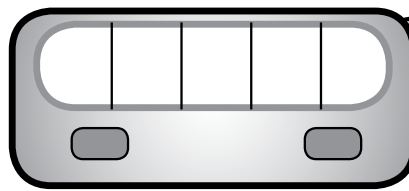

## 4. Counting in multiples of 20, 25, 50 and 100 up to at least 1 000

**Using familiar counting patterns.**

Let learners build on from the counting pattern they already know (2s, 5s, 10s) to discover, compare and explain the very regular patterns for the new counting multiples that we introduce in Grade 3.

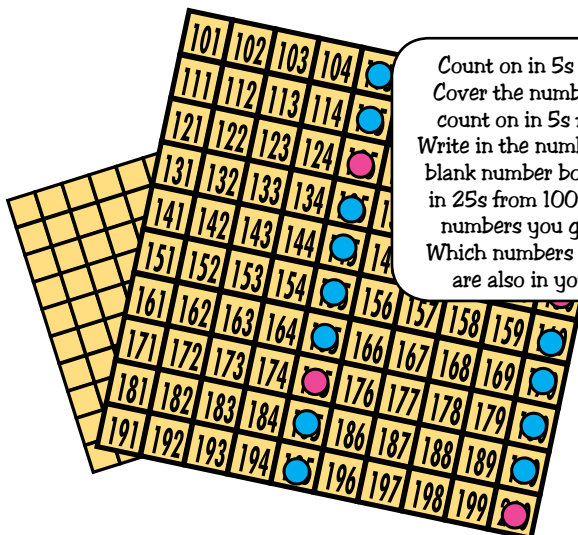

Count on in 5s from 100 to 200. Cover the numbers you say. Then count on in 5s from 200 to 300. Write in the numbers you say on the blank number board. Next count on in 25s from 100 to 200. Cover the numbers you get with counters. Which numbers in your 5s pattern, are also in your 25s pattern?



Say what you think. Which numbers from 200 to 300 will be in both your 5s and your 25s patterns?



I see a pattern here. The numbers in the 25s pattern always end in 0, 25, 50 or 75. So all the numbers I covered for the 5s pattern, that end with 00, 25, 50 or 75, are also in my 25s pattern!

So they'll be 200, 225, 250, 275, 300. I can go on and on like this, 325, 350, 375, 400... 425...

Very good thinking. Now let's investigate what's the same and what's different between the 2s and the 20s counting patterns.





## Grade 3: Numbers, operations and relationships

### Using grids

Help learners to see the relationships between the patterns for counting in different multiples by letting them summarise the relationships in grids.

	How many?					
	100s	50s	25s	20s	10s	5s
100	1	2	4	5	10	20
200						
300						
400						
500						

### Using number tracks and number lines

Let learners practise counting forwards and backwards in the Grade 3 multiples up to at least 1 000 on number tracks and on number lines.

200	220	240	260		300		340						460
-----	-----	-----	-----	--	-----	--	-----	--	--	--	--	--	-----

1 000	950	900											
-------	-----	-----	--	--	--	--	--	--	--	--	--	--	--

200	210		230		250					300
-----	-----	--	-----	--	-----	--	--	--	--	-----



Fill in the missing numbers. Write the next 10 numbers in the pattern.



You count in 20s from zero. Circle all of the numbers that are in your 20s counting pattern. Write 10 other numbers that will be in your 20s pattern.

25	40	50	100	120	265	420
480	543	600	608	960	1 000	

- Set problems on number lines that encourage learners to use their knowledge of patterns for multiples.

What number comes **halfway** between the two numbers on the number line?

Write the number in the box.

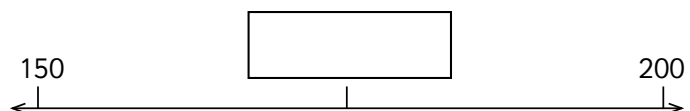

- You can also challenge learners to construct number lines using different multiples, e.g. "Draw a number line. Start at 525. Go up in 25s. Write all the numbers up to 650. Before you start, plan your number line. Work out how many numbers you must write altogether from 525 to 650. Make marks to show where each number will go. Spread your marks out evenly across your number line."
- Let learners make up their own sequences with missing numbers on number lines and give them to their friends to complete and extend. They must describe the patterns to each other.

### Work it out

Play **Work it Out** games with different multiples, e.g. "Work out the secret numbers I am thinking about. My number is more than 450 but less than 513... My number is a multiple of 20, 25 and 50.... What other number is a multiple of my secret number?"

## Grade 3: Numbers, operations and relationships

Let learners make up their own secret numbers with multiples for their friends to work out.

### Counting to solve problems

Challenge learners to use their counting patterns to do quick, efficient mental and written calculations and to solve problems. Set some problems that will encourage learners to use their doubling skills.



The timber company has 1 000 trees to plant. If they plant them in rows of 100, how many rows will they plant? ... rows of 50? ... rows of 25?

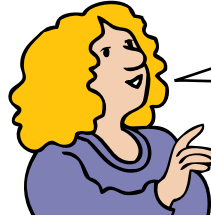

You said there are four 25s in each 100. So if you have R500, how many people can you give R25 to? ...How many can get R20 each? R50 each? (etc)

Rashida uses 20c coins to pay for this book. How many 20c coins does she use? Tick (✓) the correct answer.

36

18

54

72



Integrate calculations with big numbers into your work in other mathematical contexts. For example:

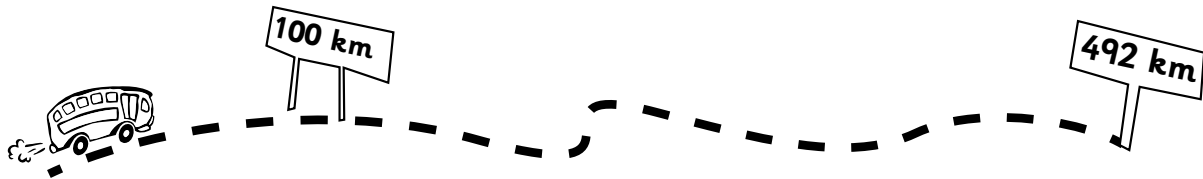

We travel 492 km to Kwa-Zulu Natal. After 100 km, we stop for lunch. How can you work out how far we still have to travel?

Tick (✓) the correct box.

$100 + \square = 492$

$100 \times \square = 492$

$100 - 492 = \square$

$492 + \square = 100$



Which 3 containers together hold one litre of paint?  
Tick (✓) the 3 containers.



## Skills and knowledge

### The learner:

- Orders, describes and compares common fractions including halves, quarters and thirds.
- Solves and explains solutions to practical problems that involve equal sharing and grouping and that lead to solutions that include unitary and non-unitary fractions (e.g.  $\frac{1}{4}$ ,  $\frac{3}{4}$ ).
- Can perform calculations, using appropriate symbols, to solve problems involving:
  - a) division of at least 2-digit by 1-digit numbers;
  - b) estimation.
- Uses the following techniques:
  - a) building up and breaking down numbers;
  - b) doubling and halving;
  - c) number lines.
- Explains own solutions to problems.
- Checks the solutions given to problems by peers.

## Suggested activities

### 1. Sharing and grouping equally

- A good way to help learners develop an interest in and an understanding of fraction concepts is to expose them to practical sharing situations that arise in various contexts in their lives, e.g. food, books, pencils, money, informal mass, length and capacity. The problems should include ones that challenge learners to find ways to deal with the 'left-over bits' or remainders. It is not necessary to introduce the terms, 'remaining' and 'remainder' until learners have had sufficient opportunities to develop their own practical understanding of these concepts.
- As learners develop confidence, ask guiding questions that will encourage them to use fraction language to describe their shares and their remainders.



## Grade 3: Numbers, operations and relationships

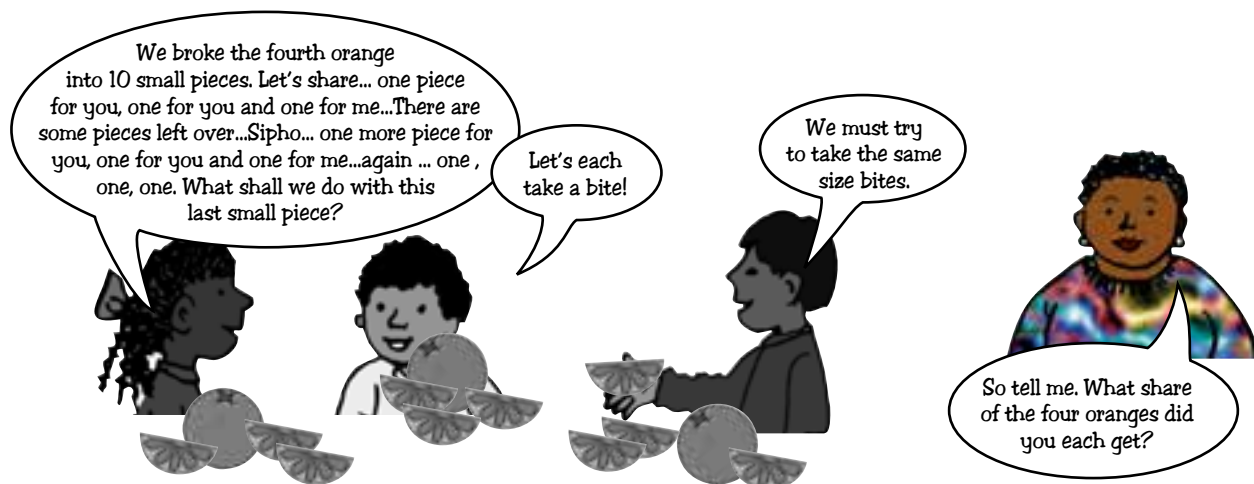

Through the year, let learners work with increasingly large whole numbers according to their growing understanding of numbers within the Grade 3 range.

- In different contexts, introduce both equal sharing and equal grouping problems. Include problems that encourage learners to make creative use of their number knowledge (e.g. knowledge of multiples) and skills (building up and breaking down, doubling and halving, using number lines and rounding off in tens).

### Examples:

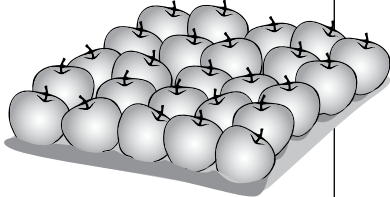
Equal sharing problems	Equal grouping problems
<p>1) We share 150 marbles equally between 3 children. How many marbles does each child get? (Learners can use knowledge of multiples of 50)</p>	<p>1) Mrs Pule has 255 apples.</p>  <p>She packs trays with 25 apples in each tray. How many trays can she pack? Will she have any apples left over? How many? (Learners can use knowledge of multiples of 25 or doubling plus knowledge of multiples of 50.)</p>
<p>2) Mr Mokoena pays out altogether R482 to his 4 workers. Each worker gets the same amount of money. How much does each worker get? (Learners must use knowledge of changing between rands and cents and they can also use multiples and/or breaking down techniques.)</p>	<p>2) Mr Mokoena shares R420 between his workers. Each worker gets R105. How many workers does Mr Mokoena have? (Learners can use building up and/or breaking down skills, or doubling and halving techniques.)</p>
<p>3) Dudu, Sipiwe, Ayanda and Joshua share 3 bars of chocolate equally. Draw what each child gets. What fraction of a chocolate does each child get? (Learners must use knowledge of non-unitary fractions.)</p>	<p>3) We need 11 children for a soccer team. 22 children come to play. How many teams can we make? How many teams with 44 children? With 88 children? How many children do you need for 10 soccer teams? (Learners can use doubling.)</p>

## Grade 3: Numbers, operations and relationships

- Give learners the time and the freedom to investigate and discuss these situations and challenge them to think of their own ways to share or group the various items. As learners investigate, ask guiding questions to encourage them to say what they think the result of the problem will be (estimate) before they start working. This will encourage them to begin to think more abstractly.
- Depending on their prior experiences and the different ways that they think and learn, different learners will use different methods and techniques to solve and record their ideas. Do not suggest that learners, who are able to imagine and represent amounts using symbols, go back to using dots or 'sticks' or other concrete representations (but allow them to do so if they feel the need). Also do not force learners to adopt somebody else's method because it seems quicker or easier. With continued exposure, practice and growing confidence, learners will naturally try to find or adopt quicker methods that they understand. Use your judgement as to when to encourage learners who lack confidence, but do understand, to draw their solutions or to use symbols to represent them.
- Let learners explain what they do and what they find out and encourage them to find different practical ways to check their own and their peers' ideas.

To find how many trays of 25 in 225 I counted in 25s. I found four 25s in 100... that is 4 bags. Another 4 bags in the next 100 ... that's eight bags. Then 2 more bags from the last 50. So she can make 10 bags and there will be 5 apples over.

25 50 75 100 □ 4  
25 50 75 100 □ 4  
25 50 □ 2  
255 - 250 = 5 left over

I broke 255 into 200 + 50 + 5. I know there are four 25s in each hundred. So, in 200 there are eight 25s. Two more 25s for the fifty... that's 10 bags altogether and she can't make another full bag from the last 5. So she can give them to her family or sell them as singles.

200 + 50 + 5  
□ □ □  
8 + 2 not a full bag.

Here is a quick way to write 'divide', or 'share equally between' or 'equal groups of'. Can you use this quick way to write what you did?

÷

Like this?  
... it says ... 255 shared into bags of 25 each ... makes 10 full bags with five left over.

255 ÷ 25 = 10 and 5 over

- As learners grow in confidence with finding their own ways to share and group, gradually introduce the appropriate maths term (divide) and symbol ( $\div$ ) that will help them use shorter ways to explain and represent their ideas.
- Give learners many different opportunities to develop the understanding that they can use the  $\div$  symbol and the division number sentence to describe both grouping and sharing problems.

For example, ask them to write a quick maths way to find the answers to grouping and sharing problems. Learners should understand that they can write  $20 \div 4 = 5$  for each type of problem.

### Grouping

How many packets of sweets can I make if I have 20 sweets and I put 4 sweets in each packet?

$$20 \div 4 = 5$$

### Sharing

Father shares R20 equally amongst his 4 family members. How much money does each one get?

## Grade 3: Numbers, operations and relationships



- Learners should be able to interpret division number sentences according to different situations.

Give me different ideas. What 'stories' or word problems do you think we can solve using numbers written like this?



My idea is 15 trees altogether. Planted in rows of 3 each. We can make 5 rows.



We shared 15 biscuits among 3 friends. Each friend gets 5 biscuits.

- You can also ask learners to find the correct number sentence for particular problems.

$18 + 3 =$

$18 - 3 =$

$18 \div 3 =$

$18 \times 3 =$

Ayesha saves all her pocket money for 3 weeks. Altogether she saved R18. How can you work out how much pocket money she gets each week?



We present problems for the different operations (adding, subtracting, multiplying and sharing/grouping) separately to illustrate the different problem types for each operation clearly. However, it is not necessary to *teach* them separately and in strict order (first adding, then subtracting, then multiplying then sharing and grouping). Make sure that you plan lessons and activities that integrate different kinds of problems. This will help learners to develop independent skills for choosing the correct operation to use in different situations.

Look at these number sums.

$18 + 3 =$

$18 - 3 =$

$18 \div 3 =$

$18 \times 3 =$

Choose the correct number sum to help you work out each number "story".

Number Story	Number sum
Thembi has 3 packets of smarties. Each packet has 18 smarties. How many smarties altogether?	
Thembi has 18 metres of material. She needs 3 metres of material to make a dress. How many dresses can she make?	
Thembi has 18 smarties. She eats 3. How many are left?	
Thembi does 18 sums at school and 3 sums at home. How many sums does she do altogether?	

Write your own ideas for number stories for each number sum.

Number sum	Number Story
$18 \times 3 =$	
$18 + 3 =$	
$18 \div 3 =$	
$18 - 3 =$	

## 2. Working with unitary fractions

As learners develop confidence with the idea of remainders, introduce problems and ask questions that encourage learners to use fraction language to describe their shares and their remainders.

Check that your learners have developed these fundamental ideas about unitary fractions from their Grade 2 work:



## Grade 3: Numbers, operations and relationships

- They can describe and use unitary fractions (one half, one third, one fifth, one twentieth). They must understand that each fraction name tells us *how many equal parts* to share different wholes into. They should be able to explain that, to find halves we must share wholes into two equal parts. To find quarters (or fourths) we share wholes into four equal parts, to find thirds we share wholes into three equal parts...to find sixths we share wholes into six equal parts... to find tenths we share wholes into \_\_\_ equal parts, to find hundredths we.....

You cut a chocolate bar into 2 equal pieces. What do you call each piece?

You share 20 crayons between 2 friends? What fraction of the 20 crayons does each friend get?

You share four apples between 4 people. How many apples does each person get?

What fraction of the four apples does each person get?

If I share 20 crayons between two of us, I share them half-half. I get a half and you get a half. Half of 20 is 10. I get 10 and you get 10.

- They know that they can use the same methods, descriptions and reasoning to find fractions of wholes that are single objects, e.g. loaf of bread or a shape, and fractions of wholes that are collections of objects, e.g. a dozen eggs or 6 single rands.

Let's see how many different ways you can fold this square into halves. How many halves will there be on each square?

These are all the ways our group found. There are two halves of the same size in each square.

You get R6 pocket money. You save a third of your money. How much do you save?

To find a third, I shared my money into 3 equal parts. So a third of R6 is R2. I save R2 every week.

These are not quarters. There are 4 pieces but they are not all the same size.

- They can explain why different shares do not show a given unit fraction.
- They know how to form wholes from given fractions.

How many half loaves make a whole loaf? Show me why you say so.

You have some sweets in a packet. You share them among 4 friends. Each friend gets 2 sweets. How many sweets were in the packet?

How many thirds of a cake make a whole cake? Show me why you say so.

You spend a quarter of your pocket money. You spend R3. How much pocket money do you get?

You have already planted a third of your cabbages. You planted 5 cabbages. How many cabbages will you plant altogether?

## Grade 3: Numbers, operations and relationships

- They can uncover, extend and use patterns for finding fractions and wholes to solve problems with unitary fractions.

We have 1 litre of milk. We give each child a quarter of a litre. How many children can we feed from 1 litre of milk?... 2 litres? ... 3 litres? 4 litres? How do you know?

Now think about this. We share a loaf of bread into fifths. How many children can we feed from 1 loaf? 2 loaves?... 4 loaves? ... 8 loaves?

We share the bread between 5 children. What fraction of the bread does each child get?... How do you know? What fraction does each get if we share between 4? ... between 2? ...between 10?

We share the bread into tenths. How many loaves will we need to feed 50 children?

- They can compare and order unitary fractions and can explain their reasoning.

Which cake is cut into halves? ... Which cake is cut into thirds? ... Which cake is cut into quarters?

You love all cake so you want the biggest piece. Which cake will you choose a slice from?... the chocolate cake, the lemon cake or the butter cake? Why do you say so?

chocolate cake

lemon cake

butter cake

Ask guiding questions until learners can explain their choice.

To make halves, we cut the cake into 2 equal pieces, like the chocolate cake. To make thirds, we cut the cake into 3 equal pieces, like the butter cake. To make quarters, we cut the cake into 4 equal pieces, like the lemon cake.

I can see that the more pieces we cut the cake into, the smaller each piece is. I choose a slice of chocolate cake... It's biggest...It's cut in half. That's only two BIG pieces.

half

quarter

third

### Important note about fraction symbols

In the early years learners do not need to be able to read or write fraction symbols. However, many educators find it useful to introduce the fraction symbols at this stage. If you decide to do so, make sure that you:

- Only introduce the symbols once learners understand how to identify and form the different fractions.
- Help learners to find out that the bottom number in fractions (denominator) does not tell us how many things there are. It **tells us how many pieces we must share the whole into**. The top number (numerator) tells us how many of those equal pieces we are referring to.

This is how we write one half quickly in maths. We read it 'one half'. This 2 at the bottom does not tell us that we have 2 things. It tells us to do something to our whole. What do you think it tells us to do to the whole?

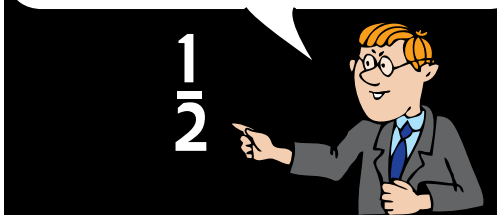

You are right Pam. The 2 tells us to share, cut, or divide our whole into two parts that are the same size. This 'one' that we write on top of the little line tells us that we are talking about one of the 2 halves.

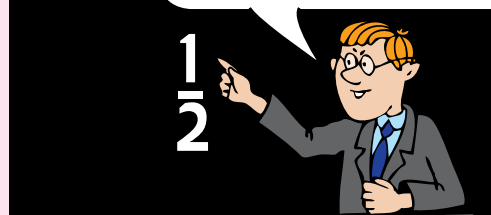

- Help learners to generalise their understanding to other fraction symbols.
- Give learners many different opportunities to use fraction symbols to label fractions of collections of objects, as well as fractions of single objects.

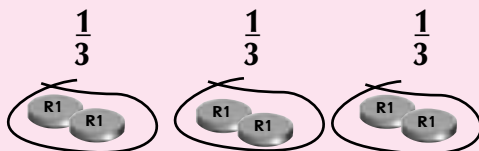

How many pieces do you think the four tells us to share our whole into? ... What does the three in this fraction tell us to do? ... The five? ... The six?

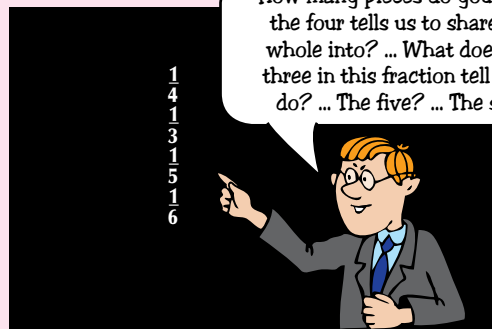

- Help learners who struggle to write the symbols by encouraging them to say, "one ... half" or "one fourth" as they write each of the two digits in the fraction.
- Help learners to develop the language to read fractions in ways that describe their meaning, rather than in ways that simply describe what they see. This is especially important when you introduce non-unitary fractions. So they should learn to say: 'one half' rather than 'one over two'; 'one fourth' or 'one quarter' rather than 'one over four'; 'two thirds' rather than 'two over three', etc.
- If you find that you have learners who have not yet developed stable concepts for unitary fractions, or cannot use them to solve different problems, give them further opportunities to work with these ideas (refer back to the Grade 2 fraction activities).

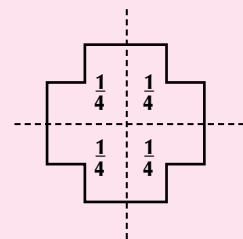

### 3. Working with non-unitary fractions

#### Naming fractions

Introduce sharing problems that encourage learners to find their own ways to name and describe non-unitary fractions, e.g. two thirds, three quarters, four fifths.



Four children share 3 bars of chocolate equally so that there is no chocolate left over. What fraction of a chocolate does each child get?

Think about this problem... How much chocolate do you think each child will get? ... More than a whole bar or less than a whole bar of chocolate? Find a way to show that you are correct.

I think it's less than a bar of chocolate each because there are 4 children and only 3 bars of chocolate. So, I cut each bar into 4 quarters. Then I give each child one quarter from each bar. Altogether each child gets 3 quarters of a bar of chocolate.

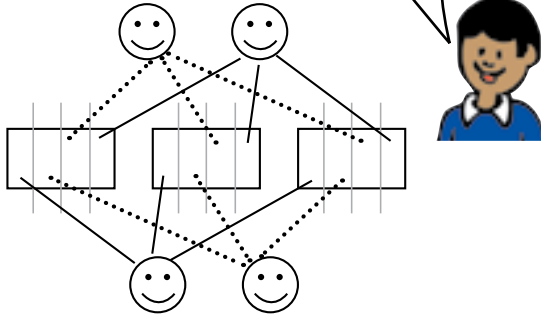

I cut the first two bars into halves. I gave each child one half of a bar. I cut the last bar into quarters. I gave each child a quarter from that bar. So each child gets a half and a quarter piece of a bar.

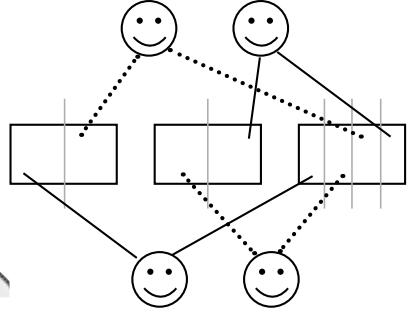

Fraction charts are useful aids for helping learners to reason out the names of other fractions. For example, make a large wall fraction chart like this:

Here are some chocolate bars. There is a whole bar at the top.

We cut the other bars into different amounts of equal pieces.

We cut the second bar into **2 halves**.

We cut the third bar into **3 thirds**.

We cut the fourth bar into **4 quarters** or **4 fourths**.

We cut the fifth bar into **5 fifths**.

We cut the sixth bar into **6 sixths**.

We cut the seventh bar into **7 sevenths**. How many pieces did we cut the next bar into? ... What do you think we call each piece? And the next bar? Can you show me two thirds of a bar ... five sixths, etc.

A whole chocolate bar									
half					half				
third			third			third			
fourth		fourth		fourth		fourth			
fifth		fifth		fifth		fifth		fifth	
sixth		sixth		sixth		sixth		sixth	



Link your work with wall charts to a variety of naming problems in different contexts. These are examples of good 'thinking questions' to ask during your 'mental maths' warm-up sessions at the beginning of your lessons:

What do you think we will call each piece if we cut a piece of string into 20 pieces?

We share a bag of potatoes equally among 9 people. What share will each person get? What share will 2 people get together?

The whole relay race is 5 times round the netball field. Each runner runs round the field once. What fraction of the race does each runner run? What fraction of the whole race do 2 runners run? ... 3 runners? How many runners do you need to run the whole race?



# Grade 3: Numbers, operations and relationships

What fraction of this shape is black?

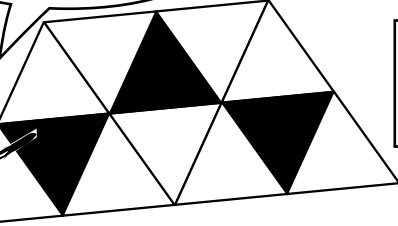

$\frac{3}{9}$     $\frac{3}{12}$     $\frac{9}{3}$     $\frac{1}{3}$

I think it must be  $\frac{3}{12}$ . There are altogether 12 triangles and 3 are black.

## Equivalent fractions

Work with suitable problems and with fraction charts can lead learners naturally into the idea of equivalent fractions as they begin to see that they can use different fraction names for the same amount.

In Mpho's way to share 3 chocolates between 4 children, each learner gets three quarter pieces. In Tsidi's way, each learner gets one half piece plus another quarter piece. Do Mpho's children get the same amount of chocolate as Tsidi's children? How can you show me?

How can we find out?

Let's measure your share and my share.

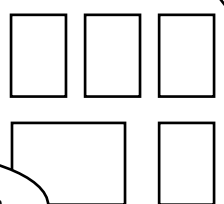

Look. Three quarter pieces is the same as a half plus a quarter.

That makes sense because there are two quarters in a half.

Link appropriate word problems to work with the fraction chart to help learners find ways to compare and order fractions.

Look at your cut up chocolate bars. Which would you prefer? A third of a chocolate bar, a half of a chocolate bar or a tenth of a chocolate bar? Why? Which would you prefer, a third of 6 bars, a half of 6 bars or a tenth of 6 bars? Why?

Which would you prefer - a third of a chocolate or two quarters of a chocolate? Why? Which would you prefer - three tenths of a chocolate or a quarter of a chocolate? Why?

Look at your chocolate bars. Find as many different fraction names as you can for a whole ... Find as many different fraction names as you can for a half.

This is how long it takes four boys to run a race. Who runs the race in the shortest time?

It must be Imran because thirteenths are smaller than quarters or sixths or eighths. So 3 thirteenths must be smaller than 3 quarters, or 3 sixths or 3 eighths.

Thabo $\frac{3}{4}$ of an hour	Thomas $\frac{3}{6}$ of an hour	Sakkie $\frac{3}{8}$ of an hour	Imran $\frac{3}{13}$ of an hour
-----------------------------------	------------------------------------	------------------------------------	------------------------------------



## Grade 3: Numbers, operations and relationships

- As learners explain and compare their different solutions to the same problem they will extend their understanding of equivalent fractions. For example:

I asked you to share 3 chocolate bars equally among 4 children. Here are the answers from the different learners in the group.

Mpho says:  $\frac{1}{4} + \frac{1}{4} + \frac{1}{4}$   
 Tumi says:  $\frac{1}{2} + \frac{1}{4}$   
 Kevin says:  $\frac{1}{8} + \frac{1}{8} + \frac{1}{2}$   
 Susan says:  $\frac{3}{4}$

How can you show me who is correct?

I made these drawings. I can see that they are all correct because all the shares are the same size.

I think  $\frac{3}{4}$  is just a quick way to write  $\frac{1}{4} + \frac{1}{4} + \frac{1}{4}$ . They both mean 3 pieces that are each a quarter the size of the chocolate.

I drew each share on a fraction chart. They are all the same size.

$\frac{1}{4}$	$\frac{1}{4}$	$\frac{1}{4}$
$\frac{1}{2}$		$\frac{1}{4}$
$\frac{1}{2}$	$\frac{1}{8}$	$\frac{1}{8}$

$\frac{1}{4} + \frac{1}{4} + \frac{1}{4} = \frac{3}{4}$

Once learners understand that they can use different fraction names for the same amount, you can challenge them to construct fraction charts and to use them to practise finding as many different 'names' as they can for different amounts that they choose.

You can also use copies of the fractions of hexagons and of circles on p358 and p359.

You could do this activity as a group challenge to see which group is able to work co-operatively to generate the largest number of equivalent fractions.

Here's a dodecahedron shaped, or 12-sided, cake. I've cut it into 12 equal slices. What is the fraction name of each piece? What can we call 2 pieces? ... 3 pieces?

I think each slice is called one twelfth. 2 slices must be 2 twelfths, 3 slices is 3 twelfths... look 3 twelfths is also a quarter

Good thinking. So how many different names can you think of for all these slices of cake? Work in your group.

I counted. It's also 1 cake plus 6 of the one-twelfth slices.

I think we can cut this cake into 6 quarters of a cake... or into 3 halves.

Let's check with our cake pieces.

It looks like 1 cake plus another half a cake.

### Putting together

These different kinds of fraction problems will help learners to begin to find their own ways to combine and re-name fractions, e.g. half + half = whole; quarter + quarter + quarter + quarter = 1;  $\frac{1}{4} + \frac{1}{4} + \frac{1}{4} = \frac{3}{4}$  etc. This work will also provide a foundation for adding and subtracting fractions.

- Introduce problems that combine whole numbers with fractions. If you use fraction symbols, make sure that your learners understand how to read and write them correctly.

$1\frac{1}{2}$  says 1 and  $\frac{1}{2}$   
 $2\frac{1}{4}$  says 2 and  $\frac{1}{4}$   
 $5\frac{1}{3}$  says?

The number in the first row shows the quick maths way to write 'one and a half'. The number in the next row says 'two and a quarter'. What do you think the last number says? Write some other numbers like these on your own. Read your numbers to your group. Use quick maths ways to write the numbers that your friends read to you.



## Grade 3: Numbers, operations and relationships

- Here are some other examples of fraction problems that will challenge learners to find ways to combine fractions:

For one cake Ma Kgaladi needs:

$\frac{1}{4}$ cup margarine	$\frac{1}{2}$ cup sugar
1 egg	$\frac{1}{2}$ cup milk
$1\frac{1}{2}$ cups flour	$2\frac{1}{2}$ teaspoons baking powder
$\frac{1}{4}$ teaspoon salt	$\frac{1}{2}$ teaspoon vanilla



How much of each ingredient does Mrs Kgaladi need for 2 cakes? ... for 3 cakes? ... for 4 cakes? ... for 5 cakes?



Ma Kgaladi makes netball skirts for the team. For each skirt she needs a third of a metre of material. How much material does she need for 2 skirts? ... for 3 skirts? ... for 4 skirts? ... for 5 skirts? ... for 6 skirts? ... for 10 skirts? ...

Ma Dhlamini has 1 metre of material. How many skirts can she make?

Baba Dhlamini has 2 and a third metres of material. How many skirts can he make?



Baba Dhlamini had 5 metres of material. He made 3 skirts. How much material has he got left?

### Counting with fractions

Learning to count in fractions will also help learners to reinforce their understanding of equivalent fractions and of combining fractions. At first, this work can be linked to practical problems or to concrete materials like fraction strips or other fraction pieces.

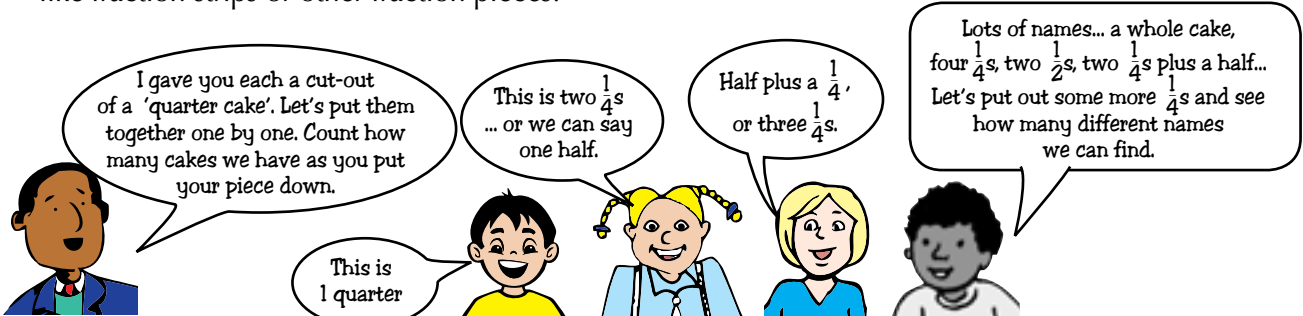

I gave you each a cut-out of a 'quarter cake'. Let's put them together one by one. Count how many cakes we have as you put your piece down.

This is 1 quarter

This is two  $\frac{1}{4}$ s ... or we can say one half.

Half plus a  $\frac{1}{4}$ , or three  $\frac{1}{4}$ s.

Lots of names... a whole cake, four  $\frac{1}{4}$ s, two  $\frac{1}{2}$ s, two  $\frac{1}{4}$ s plus a half... Let's put out some more  $\frac{1}{4}$ s and see how many different names we can find.

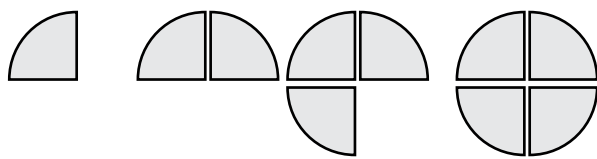

Later, learners can work more abstractly with fraction chains.

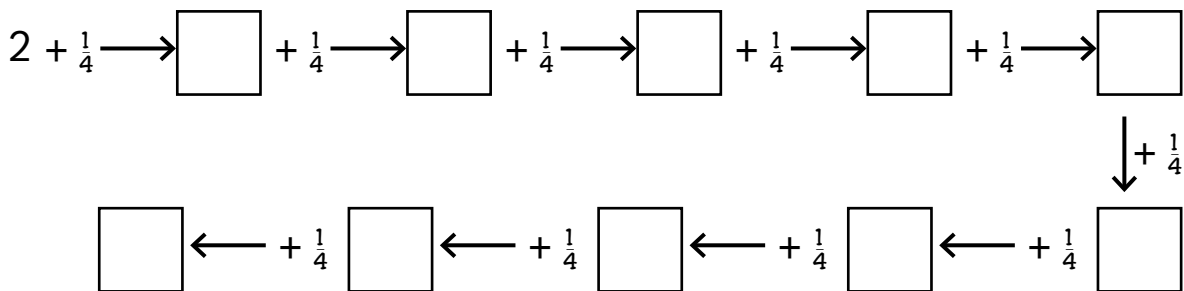

Do chains with other fractions and chains where learners must count backwards in fractions.

## Grade 3: Numbers, operations and relationships

Let learners use their counting experiences to solve linked problems.

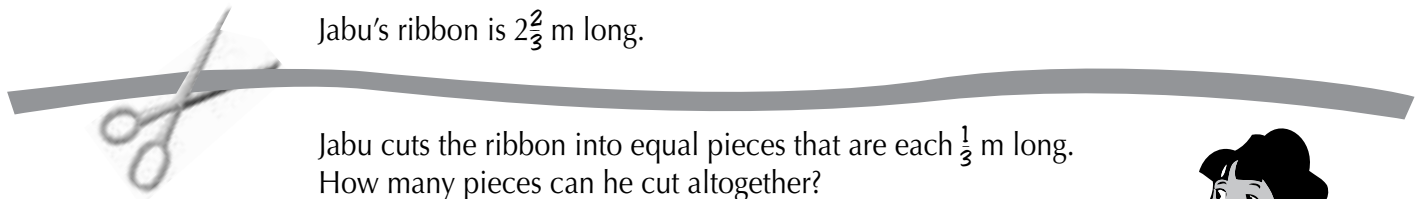

Jabu's ribbon is  $2\frac{2}{3}$  m long.

Jabu cuts the ribbon into equal pieces that are each  $\frac{1}{3}$  m long.  
How many pieces can he cut altogether?

8. Fourteen (14) girls each eat  $\frac{1}{3}$  of an orange.  
Tick (✓) the box that shows how many oranges the girls eat altogether.

$3\frac{2}{3}$	4	$4\frac{2}{3}$	$4\frac{1}{2}$
----------------	---	----------------	----------------



### Skills and knowledge

#### The learner:

- Solves money problems involving totals and change in rands and cents, including converting between rands and cents.
- Uses the following techniques:
  - a) building up and breaking down numbers;
  - b) doubling and halving;
  - c) number lines;
  - d) rounding off to tens.
- Explains own solutions to problems.
- Checks the solutions given to problems by peers.

### Suggested activities

#### 1. Building onto Grade 2 work

Check that your learners have developed these fundamental ideas and skills about money from their Grade 1 and Grade 2 work:

- know which coins and notes are used, and what they look like;
- can read and understand the abbreviations on the coins and notes, e.g. understand that 5c is short for 5 cents, the big 10 on the ten rand note means R10;
- can compare and sort coins and notes and arrange them in ascending and descending order according to their values;
- can use the appropriate abbreviations and the comma to read and write amounts of money correctly;
- can use their play money to count in 2s (R2 coins), 5s (coins) and 10s (coins and/or notes);
- can build up to different amounts of money, e.g. "Use 10c coins. Show me R5 ... Use R2 coins. Show me R10."
- can break amounts of money down into different combinations to make exchanges;

Remember to adapt these activities to suit your local currency.



You will find copies South African "play" coins on p356 and p357.

$$100c + 100c + R3$$

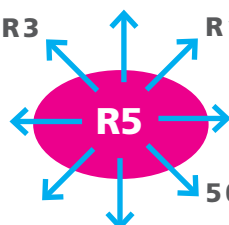

$$R1 + R1 + R1 + R1 + R1$$

$$50c + 50c + 50c + 50c + 50c + 50c + R2$$

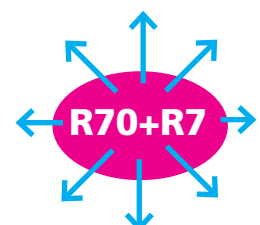
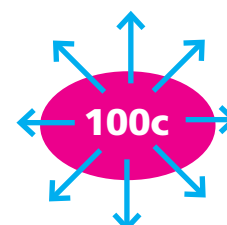

## Grade 3: Numbers, operations and relationships

- can use play money to give change, e.g. "Give me change for R2,40 from R3";
- can use counting patterns and number techniques to exchange amounts;

	How many R2 coins?		How many R5 coins?
R2		R5	
R4		R15	
R6		R20	
R8			5
R10			6
R20			20
R50			40



- can use different number techniques to solve money problems that include adding, subtracting, sharing and grouping and multiplying within the Grade 2 number ranges, e.g. "Mpho has R50. Tumi has double or half ... How much does Tumi have? Your mother spends R20 on vegetables, R14 on bread and R36 on meat. How much does she spend altogether? ... Ma Kgaladi shares some money equally between her three children. Each child gets R6. How much money did Ma Kgaladi have?... Mpho spends R21,50. She gives the shopkeeper R30. How much change does she get?";
- can explain and check their own and their peers' methods and solutions, using play money where necessary;
- understand that people invented money as a convenient way to exchange goods.

If you find that you have learners who are not yet confident with any of these ideas, use the Grade 1 and 2 activities to help them build up their knowledge and different skills for working with money.

In Grade 3 you need to extend this work to help learners build skills to:

- increase the number range in patterning, counting and problem solving up to at least 1 000;
- use multiples of twenties, twenty-fives, fifties and hundreds in the context of money;
- convert efficiently between rands and cents;
- add, subtract, multiply, divide and estimate with amounts of money;
- work mentally to add, subtract and multiply with solutions up to 50.

## 2. Working with money

### Building up to at least 1 000 with money

Let learners work with play money to make amounts up to R1 000 using their R10 and R100 notes. Once learners have worked practically with their play money, give them written exercises, like these:

- Make R100 with your R10 notes. How many R10 notes did you use?
- Stack them in a pile. Make enough piles to show R500.

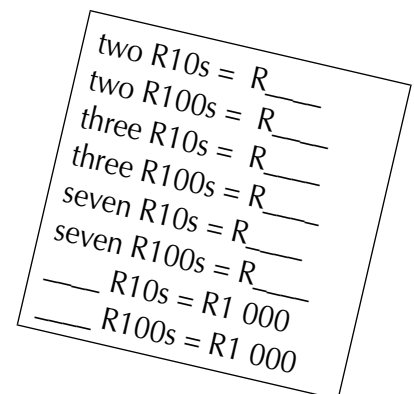

## Grade 3: Numbers, operations and relationships

- Make R500 with your R100 notes. How many did you use?
- Make piles of R10 notes to show R800. Now make R800 with your R100 notes.
- Show R1 000 using your R100 notes. Show R1 000 by making piles of R10 notes.

Extension: How many R100s do you think you need to make R2 000?

Extension: How many R10 notes do you need to make R2 000?

Ask learners to look for patterns in their answers and to tell you about these.

- Let learners who need to work more concretely use spinners and play money to count in tens and hundreds.
  - Learners race to be the first one to get R1 000 (and later, as an extension, to R2 000).
  - They take turns to spin the three spinners.
  - The number that each spinner lands on tells players how many R1s, R10s and R100s the banker must give them.
  - After each turn, players find ways to add their money.

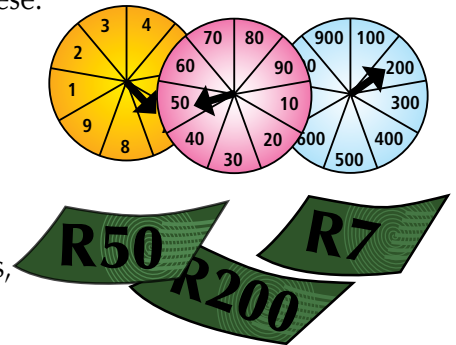

Let learners practise counting in other Grade 3 multiples by changing the game. Use only the spinner that shows 1 to 9. Let the number the spinner lands on tell learners how many, for example, R20s the banker must give them. On other occasions the spinner can show how many R25s or R50s they must get at each turn.

On my first turn the spinners landed on R8 and R70 and R300. Altogether I got R378. This turn, the spinner landed on R3 and R20 and R200... Banker, please give me another R223. Let me add. 300 plus 200 is 500 ... 500 plus 70 plus 20 is 590. Plus another 8 makes 598 ... and 3 is 599, 600, 601. Whew I'm more than half way there.



- Also, during your mental sessions at the beginning of your money lessons, set challenges that encourage learners to extend their counting in multiples up to at least 1 000, e.g. "You have R50 notes. How many R50 notes do you need to get R400? ... to R450? ... How many R20s to get to R400? ... to R450? Will you need other notes to get to exactly R450?... which notes?"

### Converting between rands and cents

- During your mental maths sessions also set challenges that encourage learners to use counting in multiples of 100 and number techniques to convert cents to rands and rands to cents, e.g. "There are altogether 100 cents in a rand. So how many cents in R2? ... in R4? ... R8? ... R10? ... How many rands can you make from 900 cents? Will you have any cents over? How many rands from 450 cents? Will you have any cents over? ... How many? How many cents do you need to make R3,50? ... R5,69?... Tell us how you worked that out".

## Grade 3: Numbers, operations and relationships

- Then let learners work in pairs or in small groups to use their counting and number skills to practise converting between rands and cents:

	How many cents?
R2	
R4	
R6	
R8	
R10	
R2,20	
R2,40	
R2,60	
R2,80	
R3,00	
R4,25	
R5,50	

	How many rands and cents?
1 000c	
500c	
250c	
125c	

	How many rands and cents?
125c	
250c	
375c	
500c	
625c	
750c	
875c	

Look at the pattern going down the table from 125c. Use the pattern to find how many cents you must write in the last row.



### 3. Word problems with money

Present learners with various kinds of word problems with amounts of money within the Grade 3 number range. For example:



Rashida uses 20c coins to pay for this book. How many 20c coins does she use?

5 apples cost R6. How much do 11 apples cost?

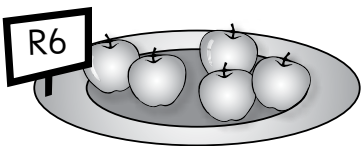

The table shows how much pocket money children from three families get.

- How much does Child 1 in the Nkosi family get?
- How much pocket money do the children from all 3 families get altogether?

	Venter family	Nkosi family	Patel family
<b>Child 1</b>	R14, 50		R17,50
<b>Child 2</b>	R 4,00	R3,00	R2,75
<b>Total</b>		R19,75	R20,25

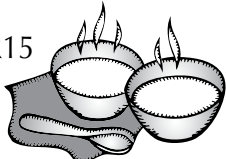
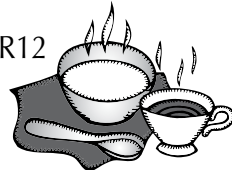
R15  R12 

Two plates of porridge cost R15. One plate of porridge + one cup of tea cost R12. How much does one plate of porridge cost? How much does one cup of tea cost?

Busi's mother gives her some money. Busi spends R39. She has R14 left. Which of these sums can you use to work out how much money Busi's mother gave her?

$$39 + 14 = \square$$

$$\square - 39 = 14$$

$$14 \times 39 = \square$$

$$39 - 14 = \square$$

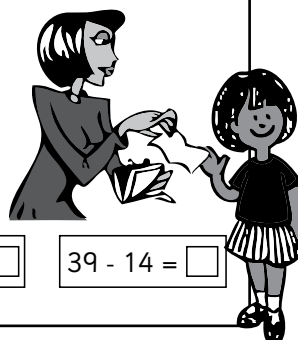

You can make copies of the worksheet on p369.

## Skills and knowledge

### The learners:

- Can perform calculations, using appropriate symbols, to solve problems involving:
  - a) addition and subtraction of whole numbers with at least 3 digits;
  - b) estimation.
- Performs mental calculations involving addition and subtraction for numbers to at least 50.
- Uses the following techniques:
  - a) building up and breaking down numbers;
  - b) doubling and halving;
  - c) number lines;
  - d) rounding off in tens.
- Explains own solutions to problems.
- Checks the solutions given to problems by peers.

## Suggested activities

### Practical problem solving

Help learners to develop addition and subtraction skills by presenting them with a wide variety of relevant practical problems that relate to their lives.

You will find that, if you start by introducing challenging problems, different learners may use different operations, in different ways, to solve them. They may solve what you think of as an 'addition problem' by subtracting, or a 'multiplying problem' by repeated addition. They will also use different techniques and skills. In this way learners learn to fall back on their own resources to discover and use number facts.

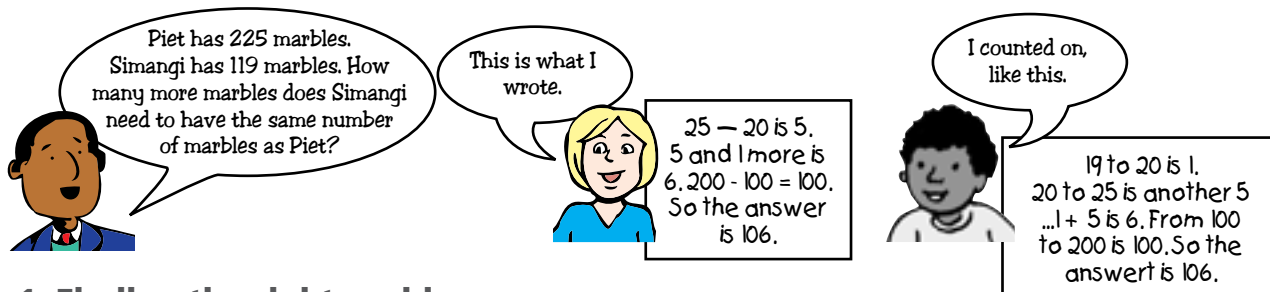

### 1. Finding the right problems

The level of the problems you set must cater for the different needs and levels of all the learners in your class. One way to do this is to build up sets of simple work cards that challenge at different levels. There are a number of ways to adjust problems to challenge learners appropriately:

- Use **different contexts** to adapt the problems to your learners' interests, and home and school environments. This helps them discover how to use and extend their number knowledge and techniques in different situations.
- **Increase or decrease the size of the numbers** to match different learners' number knowledge and your grade level.
- Use **different problem types**. The four main problem types for adding and subtracting are: change problems, comparing problems, equalising problems and combining problems. We give examples of the main problem types in the table at the end of this section.



## Grade 3: Numbers, operations and relationships

To encourage learners to use their number skills in different ways, change the **position of the 'unknown'** (the part of the problem that your learners must find out) in each type of problem. Here are three ways to change the position of the unknown:

**'Start unknown'** - Place the unknown at the beginning of the problem, e.g. "Mpho has some biscuits. Sam gives him 4 more biscuits. Now Mpho has 12 biscuits. How many biscuits did Mpho start with?"

We can represent these types of problems mathematically like this:

$$\square + 4 = 12$$

(Learners do not need to know this to start with. They will gradually learn to read and write the number sentences as you help them to extend their own early, informal ways to read and write maths.)

**'Change unknown'** – the unknown is in this position:

$$8 - \square = 1. \text{ For example:}$$

"Jan had 8 marbles.

He loses some to Popo. He has only 1 marble left. How many marbles did Jan lose to Popo?"

**'Result unknown'** - the unknown is in this position:

$$2 + 5 = \square \text{ or } 5 - 2 = \square$$

For example: "To get to school, Lesego walks 2 km to the bus stop and then travels 5 km on the bus. How far is Lesego's school from his house?"

## 2. Number techniques and skills

Present activities and word problems that encourage learners to use, extend and practise their number techniques and skills:

- **Counting in Grade 3 multiples**

$$125 + 25 + 50 + 25 = \square$$

The 25s pattern goes, 25, 50, 75, 100, 125, 150...  
I used that pattern to add  $125 + 25 + 50 + 25$ .  
I know there are two 25s in 50. So I counted four 25s on from 125.

125, 150, 175, 200, 225

$$150 + 450 = \square$$

Counting in 50s is easy!  
The pattern goes in 50s and 100s.  
I counted on in 50s and 100s to do this sum.

450 + 50 is 500; 500 + 100 is 600

- **Building up and breaking down numbers**

For example: "You have R237. Find as many different ways as possible to share the R237 between two people" e.g. R117 for one person and R120 for the other; R200 plus 37, etc...

"And among 3 people?"

- **Doubling and halving**

Help learners see, for example, that if half of 6 is 3, then half of 60 must be 30 and half of 600 is 300... or, if double of 6 is 12, double of 60 is 120.

Half of 6 is \_\_\_\_\_  
Half of 60 is \_\_\_\_\_  
Half of 260 is \_\_\_\_\_  
Half of 460 is \_\_\_\_\_  
Half of 860 is \_\_\_\_\_

2 doubled is \_\_\_\_\_  
20 doubled is \_\_\_\_\_  
120 doubled is \_\_\_\_\_  
220 doubled is \_\_\_\_\_  
420 doubled is \_\_\_\_\_

## Grade 3: Numbers, operations and relationships

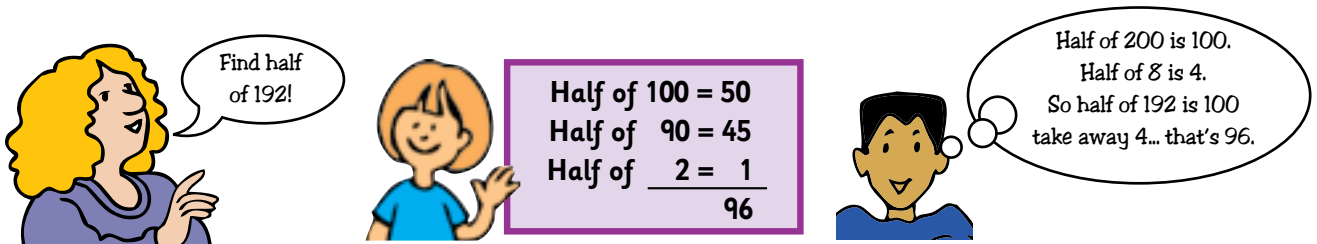

There are 93 girls in the class and 78 boys, how many more girls are there? Thabo draws a number line like this:

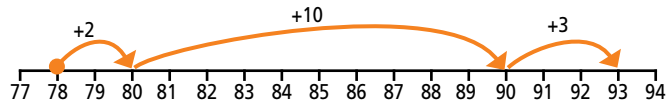

**Answer:  $2 + 10 + 3 = 15$**

- As learners build understanding of how to use **number lines**, they may choose to use them as aids to solve and record their solution methods. For example, to solve this problem:

- Rounding off to tens**  
For example: Dikeledi spends R179. How much change will she get from R200?

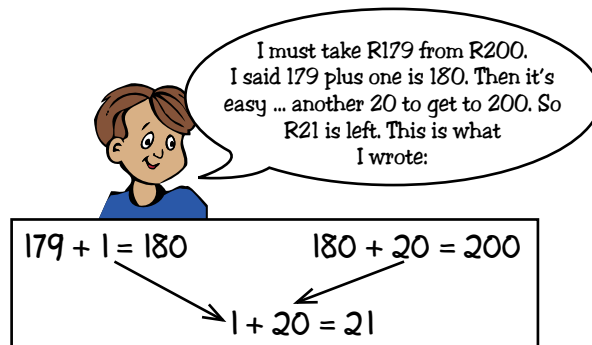

Here are examples of the main types of adding and subtracting problems you should introduce in Grade 3. Notice that the problem types are the same as those suggested for Grade 1 and 2. We change them to meet Grade 3 requirements by increasing the number range to include numbers up to at least 1 000.

Table of main problem types for addition and subtraction	
Change problems	
<p><b>Start unknown</b></p> <p><math>\square + 24 = 350</math></p> <p><math>\square - 425 = 15</math></p>	<p>1) Mpho bought cold drinks for a party. Sam brought 24 more. Now Mpho has 350 cold drinks altogether. How many cold drinks did Mpho buy?</p> <p>2) Mpho's mother has some money. She spends R425. She has R15 left. How much did Mpho's mother have before she went shopping?</p>
<p><b>Change unknown</b></p> <p>45 mins + <math>\square</math> = 1 hour 25 mins.</p> <p>742 - <math>\square</math> = 520</p>	<p>1) Jan spends 45 minutes on maths. Then he spends some time doing English. Altogether he works for 1 hour 25 minutes. For how long did he do English?</p> <p>2) Mpho has R742. He buys meat for the party. He has R520 left. How much did he spend on meat?</p>

## Grade 3: Numbers, operations and relationships

<p><b>Result unknown</b></p> <p><math>457 + 114 = \square</math></p> <p><math>315 - 35 = \square</math></p>	<p>1) To get to his farm, Mr Ncube travels 457 km by train and 114 km by bus. How far does Mr Ncube travel?</p> <p>2) Sam has R315. He spends R35 on cold drinks. How much does he have left?</p>
<b>Comparing problems</b>	
<p><b>Start unknown</b></p>	<p>1) Groot School has more learners than Batlisanang School. Groot has 109 more learners than Batlisanang. Batlisanang has 511 learners. How many learners does Groot School have?</p> <p>2) Groot School has 150 less learners than Park School. Park School has 750 learners. How many learners does Groot School have?</p>
<p><b>Change unknown</b></p>	<p>1) Park School has 750 learners. Farm School has 900 learners. How many <b>more</b> learners does Farm School have than Park School?</p> <p>2) Park School has 750 learners. Farm School has 900 learners. How many <b>less</b> learners does Park School have than Farm School?</p>
<p><b>Result unknown</b></p>	<p>1) Farm School has 900 learners. Farm School has 150 <b>more</b> learners than Park School. How many learners does Park School have?</p> <p>2) Park School has 750 learners. Park School has 150 <b>fewer</b> learners than Farm School. How many learners does Farm School have?</p>
<b>Equalising problems</b>	
<p><b>Start unknown</b></p>	<p>1) Sue and Simangi have a swimming competition. Sue swims 45 metres further than Simangi. Sue swims 201 metres. How far did Simangi swim?</p> <p>2) Sue and Simangi have a swimming competition. Simangi swims 45 metres less than Sue. Simangi swims 246 metres. How far does Sue swim?</p>
<p><b>Change unknown</b></p>	<p>1) Sue swims 201 metres. Simangi swims 246 metres. How much further must Sue swim to catch up to Simangi?</p> <p>2) Sue swims 201 metres. Simangi swims 246 metres. Who swims a shorter distance? How much shorter?</p>
<p><b>Result unknown</b></p>	<p>1) Simangi hops 159 times. Sue must make 3 <b>more</b> hops to catch up to Simangi. How many hops does Sue make?</p> <p>2) Simangi hops 159 times. Sue makes 3 <b>less</b> hops than Simangi. How many hops does Sue make?</p>
<b>Combining problems</b>	
<p><b>Start unknown</b></p>	<p>The Spaza has bread to sell. There are 134 brown loaves and 99 white loaves. How many loaves altogether?</p>
<p><b>Change unknown</b></p>	<p>There are 356 children in the school. 180 are boys. How many are girls?</p>
<p><b>Result unknown</b></p>	<p>Ranjit travels for 655 kilometres to Grootvlei and 299 km to Mpani. How far is his whole trip?</p>

### Reasoning, discussing and checking

- Give learners the time and the freedom to work in pairs or in small groups to **investigate and discuss** these situations.
- Encourage learners to **estimate** the result of the problems before they start calculating – this will encourage them to begin to think more abstractly by **imagining** the problem situations and their outcomes.

## Grade 3: Numbers, operations and relationships

- Challenge learners to **think of their own ways** to solve the problems, using their available number knowledge and skills (e.g. counting in different ways, place value, exchanging money) and techniques (building up and breaking down numbers, doubling and halving, number lines and rounding off). Expecting learners to use formal calculating methods from the beginning confuses and de-motivates them.

Explain to the class how you found the answer to  $151 + 98$  so quickly, Ben.



$151 + 98 \dots$

First I added 2 to 98 to round it off to 100. That gave me  $151 + 100$ , but then I had to take away 2 from 151 to make up for the 2 that I added in.

So that left me with  $149 + 100$ .

Adding onto 100 is easy peasy!  
 $100 + 149 = 249!$

- Expose your learners to **different ideas about how to solve problems**, let them take turns to use their own informal language to **share and explain** what they do and what they find out. Remember that home language is our most powerful learning and thinking language.

- Encourage learners to listen carefully to each other's explanations and to find different practical ways to **check their own and their peers' ideas and calculation methods**. Where necessary, ask guiding questions to help them clarify and extend their ideas.

This is how I subtracted 78 from 93.



$93 - 73 = 20$   
 $20 - 5 = 15$   
so  $93 - 78$  is 15

Why did you take 5 away here?

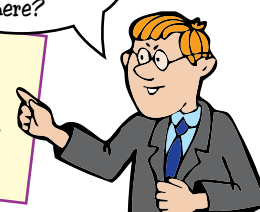

- As you observe, **assess how different learners are thinking and what support they need**. Also judge when learners are ready to be encouraged to move from their early informal methods to more compact and formal methods. Let learners, who still need to work with concrete aids, do so. As they gain confidence and experience, learners will gradually adopt 'shortcuts'.
- As you see that various learners understand and are confident with the new maths ideas, **gradually introduce abstract number sentences in different formats** and help learners to find ways to interpret and solve them. Use small numbers as you introduce the more difficult formats like 'start' and 'change' unknown.

Give me different ideas. What stories or word problems do you think we can solve using numbers written like this?



$$40 - \square = 37$$

$$\square - 3 = 137$$

My idea for the first sum is this: I have 40 peaches. I eat some of my peaches. Then I have 37 left. We must find out how many peaches we ate.



For the second sum I think we can say: I have some peaches and I eat 3. Then I have 137 left. We must find out how many peaches we had before we ate 3.

Do you think you had more or less peaches to start with? ... How many more or less? ... How can you find out how many peaches you started with?



- You can also ask learners to **choose the correct number sentence** format for particular problems.

We travel 492 km to Kwa-Zulu Natal. After 100 km, we stop for lunch. How can you work out how far we still have to travel?



100 km

492 km

$$100 + \square = 492$$

$$100 \times \square = 492$$

$$100 - 492 = \square$$

$$492 + \square = 100$$



## Grade 3: Numbers, operations and relationships

- Also invite learners to **make up their own problems** with different formats in different contexts.
- Introduce learners to **other mathematical formats** that will help them to organise their ideas systematically. For example, as they start to work with 100s, Grade 3 learners will find that the vertical layout, where they line up digits of the same value underneath each other, is a useful way to help them keep track of what they do.

Learners' own informal vertical methods act as 'stepping stones' that will help them bridge to the shorter vertical methods from Grade 4 onwards. Give them lots of practice so that they can share their ideas and model additional 'shortcuts' as they become ready to progress to more standard forms.

The builder puts 186 kg of sand and 33 kg of stone in his bakkie. How heavy is his load?

I did this.

$$\begin{array}{r} 186 + 33 \\ 80 + 30 = 110 \\ 6 + 3 = 9 \\ \hline 219 \end{array}$$

I added 186 and 33 like this.

$$\begin{array}{r} 100 + 80 + 6 \\ + \quad 30 + 3 \\ \hline 100 + 110 + 9 = 219 \end{array}$$

I wrote 110 and 100 and 9 under each other to help me add them quickly.

$$\begin{array}{r} 110 \\ 100 \\ \hline 9 \\ \hline 219 \end{array}$$

### Remember:

Never force learners to adopt somebody else's method because it seems quicker or easier. With continued exposure, practice and growing understanding and confidence, learners will naturally try to find or adopt quicker methods to illustrate their thinking.

## Skills and knowledge

### The learner:

- Can perform calculations, using appropriate symbols, to solve problems involving:
  - a) multiplication of at least whole 2-digit by 1-digit numbers;
  - b) estimation.
- Performs mental calculations involving multiplication of whole numbers with solutions to at least 50.
- Uses the following techniques:
  - a) building up and breaking down numbers;
  - b) doubling and halving;
  - c) number lines;
  - d) rounding off in tens.
- Explains own solutions to problems.
- Checks the solutions given to problems by peers.

## Suggested activities

When learners can 'sing' their multiplication tables, it does not necessarily mean that they know what the tables mean, or, that they can use the multiplication facts from their tables in other situations. So, instead of 'learning multiplication' only by 'doing tables', you should focus on giving learners many different kinds of experiences through the year that will help them to build understanding of:

- the multiplication number facts for the multiples they worked with in Grade 1 and 2 (2s, 5s, 10s);
- how to use mathematical formats and symbols to represent multiplication facts;
- how to use patterning and number techniques to extend their understanding of multiplication facts to other multiplication facts (e.g. for 3s, 4s, 6s, 8s and 7s);
- how to use patterning and number techniques to extend their knowledge of multiplication facts to the multiples they learn about in Grade 3 (20s, 25s, 50s and 100s);
- use multiplication facts they know to solve various types of problems.

1. Check that learners can find their own ways to interpret 'multiplication language'.  
Let them explain their methods to each other.

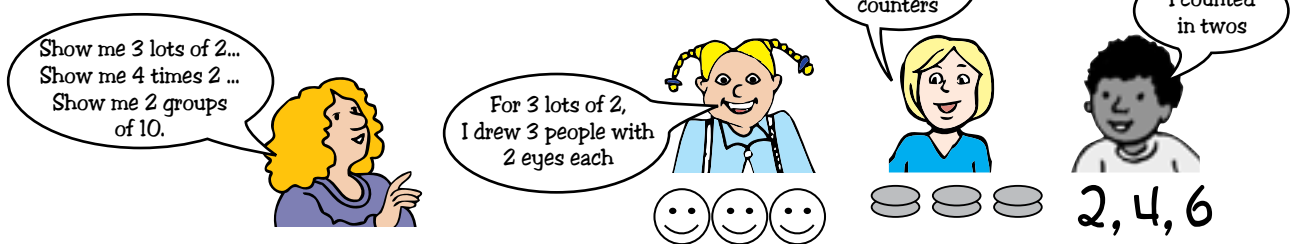

2. Check that learners can find their own ways to interpret multiplication symbols.  
Let them explain their ideas to each other.

As learners begin to use this format, look out for learners who make the common error of *adding* the two numbers in multiplication number sentences. Give these learners more experience of linking the repeated adding format to the multiplication format.

$$\begin{array}{c} \text{2} \\ \text{---} \\ \text{2} \end{array} + \begin{array}{c} \text{2} \\ \text{---} \\ \text{2} \end{array} + \begin{array}{c} \text{2} \\ \text{---} \\ \text{2} \end{array} + \begin{array}{c} \text{2} \\ \text{---} \\ \text{2} \end{array} = 8$$

$$2 \times 4 = 8 \quad \text{or} \quad 4 \times 2 = 8$$

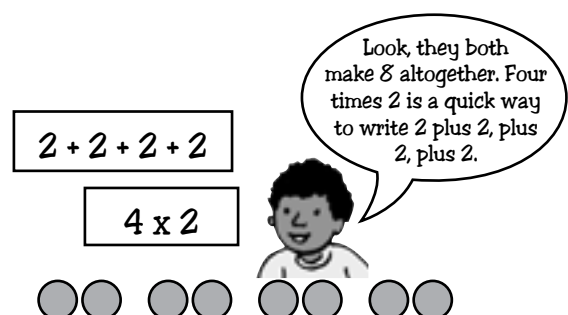



# Grade 3: Numbers, operations and relationships

3. Help learners extend their knowledge of multiplication facts by giving them opportunities to see the relationships between, say, 3 groups of 4 and four groups of 3. For example: "Show me 3 fours and then show me four 3s. What's the same? What's different? Show me 2 fives and then show me five 2s. What's the same? What's different? ..."

I notice you can turn the numbers around between sharing and multiplying. 4 taken 3 times is 12. 12 shared between 3 people... they will each get 4 and 12 shared between 4... each will get 3.

What interesting patterns! I wonder if you can always turn the numbers around when you break them into equal groups.

Let's investigate. Mpho and Kevin, find out what happens with 6 oranges, Tumi and Kelibogile, find out what happens with 24 oranges.

4. Help learners see the relationship between sharing and grouping and multiplying. For example: "Show me four multiplied by 3. Then show me 12 shared between 3 people. Lastly show me 12 shared between 4. What do you notice?"

5. Give learners many opportunities to practise finding, summarising and extending their multiplication facts for the multiples they know.

Children	1	2	3	4	5	6	7	8	9	10	11	12	13	14
Legs	2	4												
Fingers on 1 hand	5													
Toes on 2 feet	10	20		40										140

6. Help learners use their number techniques to extend their knowledge of multiplication facts to other 1-digit numbers. For example:

### Doubling

	1	2	3	4	5	6	7	8	9	10	11	12	13	14
2s	2	4												
4s	4	8												
8s	8	16												

### Using drawings and counting to gather new multiplication facts:

Find how many legs altogether on 3-legged stools.

Stools	1	2	3	4	5	6	7	8	9
Draw how many legs		 							
Number of legs	3	6							

### Using number lines

Drawing number lines to show counting with these number facts.

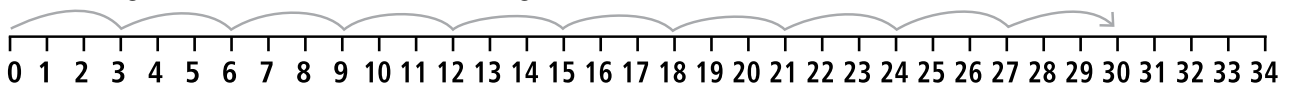

### Using grids

Extending to related multiples in grids and on number lines:

	1	2	3	4	5	6	7	8	9	10
3s	3	6	9							30
6s	6	12								60
9s	9	18	27							90

I found a quick way to find the numbers for the groups of nines. I added the numbers for the groups of 3 and the numbers for the groups of 6 each time.

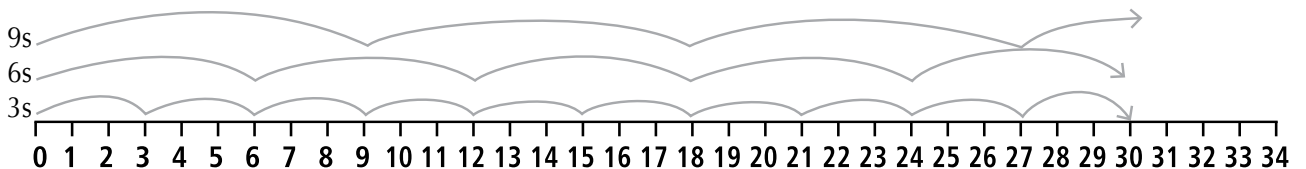

## Grade 3: Numbers, operations and relationships

### Finding different ways to break numbers of objects up into equal groups

For example, “Ma Kgaladi has 12 oranges to sell. She puts the same number of oranges on each plate. How many different ways can she put out her oranges? Write what you did and explain your different ways of making equal groups”.

- Give learners opportunities to summarise and compare the counting patterns for their new Grade 3 multiples in different ways.

#### Using grids

Counting in 20s				
20	40	60	80	100
120	140	160		

Counting in 25s			
25	50	75	100

50s	
50	100

100s

	How many?			
	100s	50s	25s	20s
<b>100</b>	1	2	4	5
<b>200</b>				
<b>300</b>				
<b>400</b>				
<b>500</b>				

#### Using number lines

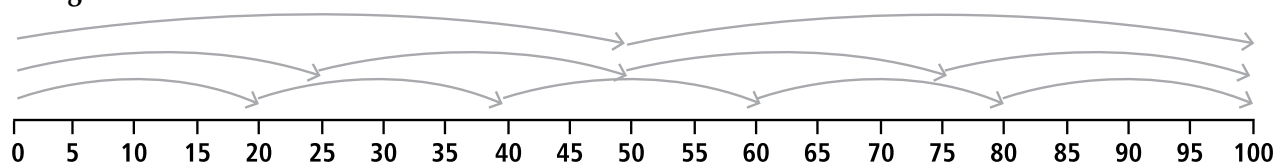

- During the mental maths sessions before your multiplication lessons, ask related questions that encourage learners to use the multiplication facts they have learned:
  - “You have three 3-legged pots. How many legs altogether?”
  - “Ma DIlhamini gives each of her 5 children R3. How much does she give them altogether?”
  - “Jabu trains for athletics for 25 minutes everyday of the week. How many minutes does he train each week?”
- Challenge learners to use and extend their multiplication number facts by posing a variety of practical multiplication problems. Use the same multiplication problem types as learners worked with in Grade 2 (see table). Extend the number range to include multiplying 2-digit by 1-digit numbers. You can also include combination type problems. (Use small numbers for this new format.)

# Grade 3: Numbers, operations and relationships

Problem type	Examples
<b>Repeated addition</b>	a) For the school outing, the mothers make 4 sandwiches for each of the 25 learners. How many sandwiches do they make altogether? b) There are 50 oranges in each bag. You buy 7 bags. How many oranges do you buy altogether?
<b>Rate</b>	a) Bra Samuel earns R20 an hour. How much does he earn in 8 hours? b) The newspaperman delivers 75 newspapers a day. How many newspapers does he deliver in 3 days?
<b>Grids</b>	a) Jabu plants 15 bean plants in a row. She plants 5 rows of bean plants. How many bean plants does she plant altogether? b) Tumi can fit 6 rows of 15 tiles onto his kitchen floor. Draw Tumi's tiled floor. How many tiles must he buy?
<b>Combinations</b>	a) Here are Peter's shirts and shorts. <div style="text-align: center;">  </div> How many different outfit combinations can Peter make from his shirts and shorts?

- Encourage learners to *estimate* the result of the problems before they start working.
- Let learners find their own ways to solve the problems and to record their results. Let them share their methods and find ways to check each other's solutions and ways of working.

I counted to find out how many plants in 5 rows of 15 plants. First I counted five tens. Then I counted on five more 5s. 75 plants altogether.



10, 20, 30, 40, 50,  
55, 60, 65, 70, 75.

I doubled like this:



15, 30, 60, (4 rows)  
+ 15 (last row) is 75

I broke my numbers up like this:



$$15 = 10 + 5$$

$$10 + 5$$

$$10 + 5$$

$$10 + 5$$

$$10 + 5$$

$$\underline{10 + 5}$$

$$50 + 25 = 75$$

- Give learners lots of practice time so that they can share their ideas and so that you can model additional 'shortcuts' as they become ready to progress to the more formal vertical methods required in Grade 4.

The builder puts 186 kg of sand and 33 kg of stone in his bakkie. How heavy is his load?



I did this.



$$186 + 33$$

$$\begin{array}{r} 100 \\ 80 + 30 = 110 \\ 6 + 3 = 9 \\ \hline 219 \end{array}$$

I added 186 and 33 like this.



$$100 + 80 + 6$$

$$+ \quad 30 + 3$$

$$\hline 100 + 110 + 9 = 219$$

I wrote 110 and 100 and 9 under each other to help me add them quickly.



$$\begin{array}{r} 110 \\ 100 \\ \hline 9 \\ \hline 219 \end{array}$$

## Skills and knowledge

### The learner:

- Performs mental calculations involving:
  - a) addition and subtraction for numbers to at least 50;
  - b) multiplication of whole numbers with solutions up to at least 50.
- Uses the following techniques:
  - a) building up and breaking down numbers;
  - b) doubling and halving;
- Explains own solutions to problems.
- Checks the solutions given to problems by peers.

## Suggested activities

### 1. Developing mental tasks

As learners build maths knowledge they will gradually become more and more able to work mentally. To support this growth present them with different mental tasks (daily for about 10 to 15 minutes). The tasks should:

- interest, motivate and challenge them to think and to find their own ways to calculate mentally;
- help them to use what they know to see patterns, derive new facts and ideas and to use and practise their knowledge to solve problems;
- link their mental activity to the maths concepts and contexts they are developing, e.g. money, time, informal measurement, equal sharing and grouping, adding and subtracting, multiplying. For example, if learners are working with rounding off in tens, you may ask:



Ma Ncube buys peaches in trays of 50 each. Altogether she buys 350 peaches. How many trays does she buy?

Challenge them to link their number knowledge to different kinds of related word problems.

You can also integrate these sessions to challenge learners to work mentally with other mathematical contexts. For example, if you are working with shapes, your mental activity might encourage learners to visualise and name them.

You told me that 2 threes are 6. So, how much do you think 4 threes will be? How do you know?



You found out that 2 threes are 6 and 4 threes are 12... can you tell me what 8 threes are? ... 16 threes?

Which number is closer to 150... 148 or 153? How do you know?



The shape I am thinking of is a box. Four of its faces are rectangles. One other face is a square. What shape will the last face be? Draw the last face. Tell your friend the name of the shape. Find a box like the one I am thinking of in the classroom.



### 2. Organising your mental maths sessions

Mental maths sessions should be thinking sessions rather than rote memory or speed sessions that only require learners to give accurate answers as quickly as possible. Ensure that everybody in the class becomes involved - not only those learners with quick recall who may distract everybody else by waving their hands, clicking their fingers and/or shouting to get your attention. Through your actions, show that you respect all learners, and aim to build their confidence and ability.

## Grade 3: Numbers, operations and relationships

For example:

- Provide thinking time during which everybody must think or work quietly;
- Set rules like; “Nobody should put their hand up before I give you the signal”, or, “If you know the answers you can raise your thumb quietly to show me you have the answer!”
- Call for answers and explanations from anyone – not only those who raise their hands;
- Let learners discuss and share their different thinking methods with the whole class;

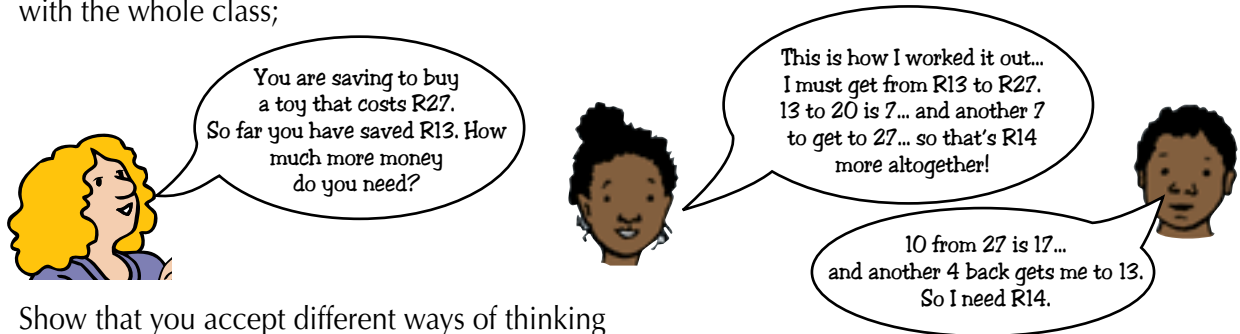

- Show that you accept different ways of thinking – as long as they make sense;
- As learners develop ways to calculate and solve problems, encourage them to speed up their responses.

At first learners will find it easier to understand and respond to questions if they see, as well as hear, them. So if learners struggle with oral presentations, show the questions on flash cards or write them on the chalkboard.

Let learners write their answers on a scrap of paper, or on a small white board or a slate. Ask questions one by one, allowing learners time to think. Show learners how to write their answers in an organised way (e.g. numbering their answers). Learners can hold up their boards after each question – when you give the signal. This encourages all learners to think and it helps you to assess learners' performance informally.

Once learners can read fairly fluently, present a series of linked questions in written form, e.g. on work cards. Learners can then work independently or in small groups to write the answers.

### Vocabulary

If you do not teach in English, use equivalents in your language of instruction.

#### Grade 1:

- number names (one, two, etc.)
- ordinal number names (first, second, third, etc.)
- more , less, fewer, as much as, a little, a lot
- same, different
- equal, about, nearly, none
- total, altogether, count
- cents, rands, exchange
- pieces, parts, share, group, share equally, share between, among
- equal shares (or parts)
- break up
- estimate
- put together, add, build up, break down, take away, subtract, (minus)
- double, halve
- number names up to 100
- count in tens.

#### Grade 2 – add the following to the Grade 1 vocabulary:

- fives, twos, odd numbers, even numbers
- fraction names e.g. half, halves, quarter(s), fourths, thirds, fifths, sixths, one and a half, two and a quarter
- wholes, parts, pieces, left over, remains, remainder
- twice, three times (etc), multiply by.

#### Grade 3 – add the following to the Grade 1 and 2 vocabulary:

- number names up to one thousand
- tens, units, ones
- twenties, twenty-fives, fifties, hundreds.

### Resources

- objects in learners' environment, different counters (e.g. bottle tops, beans, used matchsticks, plastic shapes, pencils, washing pegs, buttons, unifix blocks, leaves, sticks, stones)
- body parts (eyes, ears, limbs, fingers)
- number tracks and number lines
- number charts or boards, number cards
- sandpaper numbers
- play money
- worksheets
- calendars
- number spinners



# Grade 3: Patterns, functions and algebra

The learner will be able to recognise, describe and represent patterns and relationships as well as to solve problems using algebraic language and skills.

## Skills and knowledge

The learner:

- Copies and extends simple patterns using physical objects and drawings.
- Creates own patterns.
- Describes observed patterns.
- Identifies, describes and copies geometric patterns in natural and cultural artefacts of different cultures and times.

The vocabulary that learners need to understand and use for these skills is listed at the end of the suggested activities. You will find it helpful to make flash cards with key vocabulary words to support the teaching and learning process. A list of the resources you will need for the activities is also provided.

## Suggested activities

Review the patterning activities for Grade 1 and 2. Repeat any of the activities you think will better prepare your learners for managing the activities in this section. Read through the activities carefully. Think about how you will build them into your plan for the year. Consider which activities integrate well across other mathematical contexts.

- For example, number patterns like these help to develop your learners' counting skills:  
146; 150; 154; 158; 162; ...  
325; 300; 275; 250; 225; ...

What's the counting pattern here? What numbers come next or before?



- You can link shape pattern investigations with symmetry ideas:

○ ⊗ ⊗ ⊗ ○ ⊗ ⊗ ⊗ ⊗ ○ ○ ○ ⊗ ⊗ ⊗ ○ ○ ○ ○ ⊗ ⊗ ⊗ ○ ⊗ ⊗ ⊗ ⊗ ○ ○ ⊗ ⊗ ⊗ ○ ○

"Which of these patterns repeat? Which does not have symmetry?"

- Time patterns can help learners to count on in different time intervals:

Follow the pattern. Fill in the missing times.

10:15; 10:30; 10:45; 11:00; 11:15; \_\_\_\_; \_\_\_\_; 12:00

- Look for patterns in different kinds of collected data:

Grade 3M: Number of learners absent				
Monday	🍏			
Tuesday	🍏	🍏		
Wednesday	🍏	🍏	🍏	
Thursday	🍏	🍏		
Friday	🍏			

What pattern do you notice in this set of data?

### Why study patterns?

Patterns bring order to our worlds and our experiences. From early on, children observe patterns in all kinds of situations as they observe the world around them. These might be patterns made by people, like this tiling pattern:

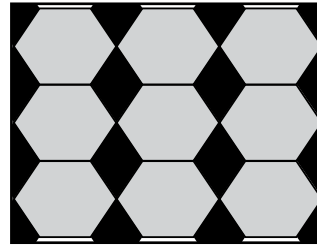

Or natural patterns, as in this piece of honeycomb:

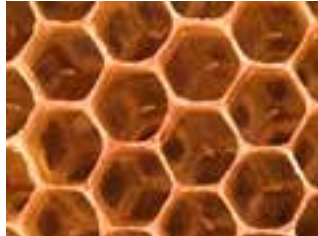

We must expose our learners to many different kinds of learning experiences where we help them to develop their thinking around what makes a pattern, show them ways to explain patterns using language, numbers, symbols or drawings. We must also help them to make predictions and generalise rules from various kinds of patterns. When investigating patterns, it is important that you help learners to:

- see the relationships between the elements of a pattern;
- identify similarities and differences in patterns;
- observe how patterns repeat, change or grow in different ways.

While we have separated the activities in the unit into shape and number patterns, the two intersect in many ways. For example, when deciding which blocks to shade to complete this pattern, learners may think about fractions (from a whole to  $\frac{3}{4}$  to  $\frac{1}{2}$  to  $\frac{1}{4}$ ).



Or when working out how many dots to draw in the next row, they need to think in doubles:

- 1
- ● 2
- ● ● ● 4
- ● ● ● ● ● ● ● 8

The last two patterns are examples of growing patterns, where there is a change in the number of elements in the pattern. In the first case, there is a decrease in the number of shaded blocks, and in the second there is an increase in the number of dots. Both increases and decreases are examples of growing patterns. We can also describe them as growing and shrinking patterns.

There are many examples of growing patterns in nature. For example, the rings in the water increase in size from the centre outwards.



## Grade 3: Patterns, functions and algebra

### Preparing the classroom

- Collect photographs and posters of different kinds of patterns to create wall displays for the classroom. Use A2 paper with square blocks to make weather charts and birthday charts. Once they are filled in, learners can analyse the data to look for patterns and trends.

#### Our Birthday Chart

Jan											
Feb											
March											
April											
May											
June											
July											
August											
September											
October											
November											
December											

Most of the class have their birthdays at the beginning and the end of the year, not in the middle of the year.

- Use pictures of life cycles of plants or animals to investigate cyclical patterns. You can do this during Science and in Numeracy lessons.

Show examples of plant/ animal life cycles different to those used in Grade 1 and 2.

That means most of them have birthdays in summer.



- Use weather charts to investigate patterns and cycles in the weather over a period a week or month. Use posters or charts showing the changing phases of the moon to talk about cyclical patterns of time and motion.
- Display a large calendar on the wall for each month. Talk about how the calendar is arranged in a pattern, where the days repeat themselves in 7-day cycles.

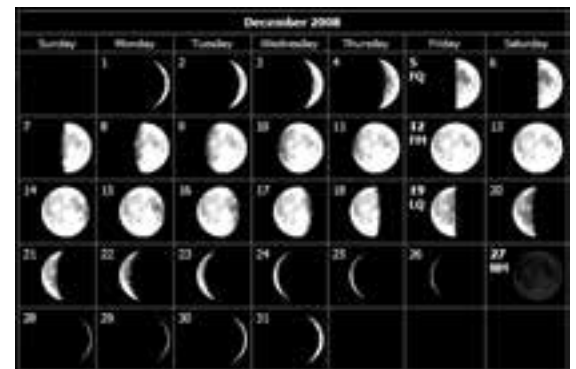

Mon	Tues	Wed	Thurs	Fri	Sat	Sun
	1	2	3	4	5	6
7	8	9	10	11	12	13
14	15	16	17	18	19	20

## Grade 3: Patterns, functions and algebra

- Ideas for natural patterns that you can make a poster or wall display include:
  - petals of different flowers
  - spiral patterns of shells
  - growing patterns in the rings of tree logs.

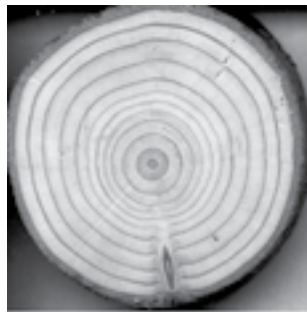

- Ideas for patterns made by people include:
  - different fencing patterns



- Brick patterns

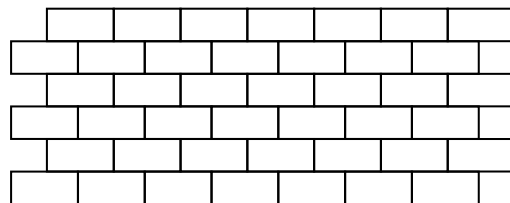

- patterns in cultural artefacts.



Talk about the different kinds of patterns together. Encourage learners to describe their unique features, their similarities and their differences.

### Out and about

Take a walk together around the school grounds to look out for different kinds of patterns - both natural and made by people. Give different learners the chance to describe and compare the patterns using their own language and vocabulary.

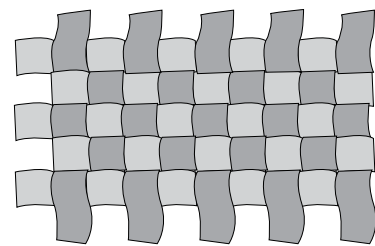

### Drawing and copying patterns

Make time for learners to draw and make models of some of their patterns using pencils, kokis, paints, paper strips or clay.

### Paper folding patterns

This activity lets learners observe the patterns created when you fold a piece of paper a number of times.

Give each learner a sheet of paper and demonstrate how to fold it in half again and again to get first halves, then quarters, then eighths. They must say how many parts they think the paper is divided into after each fold (2, then 4, then 8) and open their paper to check their predictions. After 3 folds, they must describe the increasing number pattern (doubling) and use this pattern to predict how many parts they will get if they continue to re-fold their paper in half again and again.



## Grade 3: Patterns, functions and algebra

Working with a square piece of paper, learners can investigate the pattern in the number of triangles they get by first folding once along the diagonal and then by folding the resultant triangle in half over and over again.

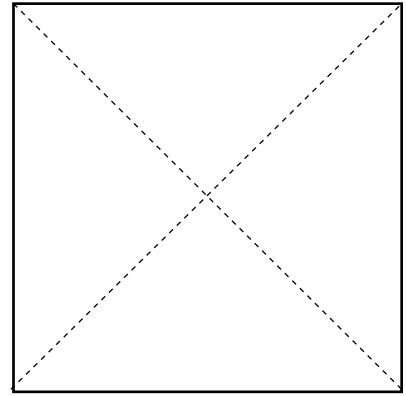

### Making repeating patterns

Collect examples of different kinds of patterned gift wrap or pieces of printed fabric. Have learners work in groups to investigate and talk about the different patterns they see. Make time for each group to share their pattern with the rest of the class.

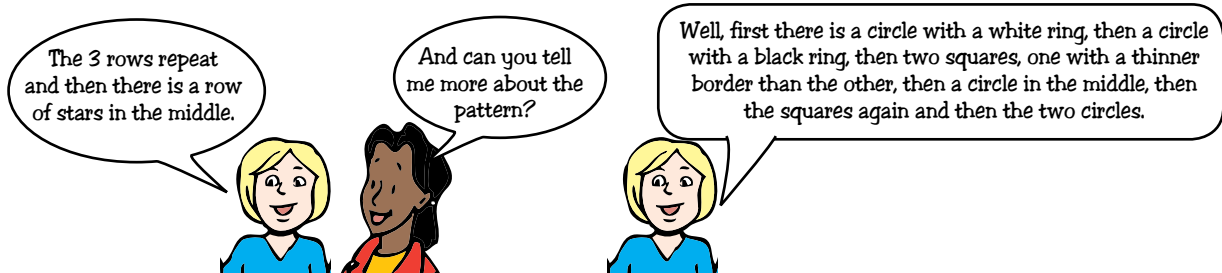
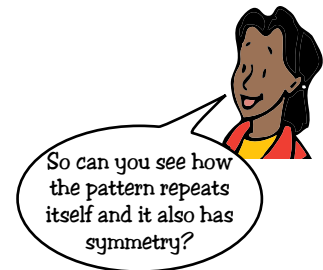
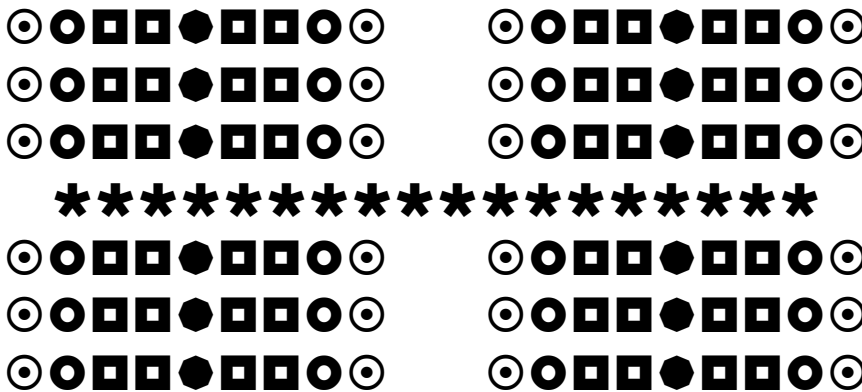

### Patterns and rhythm

- Begin a rhythmic pattern by clapping and stamping your feet and then ask learners to join in:

clap clap stamp, clap clap stamp, clap clap stamp, clap clap ...

Learners can then take turns to make up their own clapping and stamping patterns that the rest of the class or group must copy and repeat.

- Play scales up and down on a piano, recorder or harmonica. Ask learners to sing along with you and to try and 'feel' the pattern in the melody as they do.
- Play a piece of music or sing a song that your learners know well. Have them clap or stamp out the beat as they do so. Choose another piece with a slower or faster beat. Ask them to talk about the differences between the two beats.

### Linking rhythmic patterns to shape patterns

- Ask learners how to represent their clapping and stamping patterns using different shapes or colours. For example, they can show the pattern: Clap, clap, stamp, clap, clap, stamp, as:

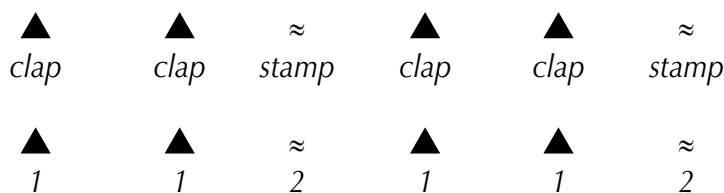

Give learners turns, where one learner makes up a clapping pattern and the rest of the group has to copy the pattern as they hear it, using plastic shapes or by drawing the shapes.

### Rhyming Poems

Collect examples of poems and songs with rhyming patterns to read to learners in the language class. Have them look for patterns made by the repeating sounds. For example:

#### The Witch

With warts on her **nose**  
 And sharp pointy **toes**,  
 She flies through the night on her broom.

With covers pulled **tight**  
 In the shadows of **night**,  
 I hide in the dark of my room.



Ask learners to find more rhyming words that match the words in the poem. For example: close, sows, hose, might, sight, right. Use examples in other languages. Let learners make up and write down their own rhyming poems.

### Bead patterns

Give learners beads or similar materials to thread to give them more opportunities to copy and create their own patterns. They may form their patterns by repeating colours, shapes, different sizes or by using different sized beads to make growing and shrinking patterns.

Examples of repeating patterns:

Example of a growing pattern:



Example of a growing and shrinking pattern:



Make time for learners to talk about their patterns and to explain how they 'work'. Encourage them to use words like: *starts again, over and over, one more time, grows, shrinks, gets bigger, gets smaller, increases and decreases*. If they are using beads of identifiable shapes, encourage them to also name and describe each shape accurately, using precise mathematical language.



## Grade 3: Patterns, functions and algebra

Also encourage them to use 'position' vocabulary using words like: *first, second, last, next, the one before, the one after, in between, to the left, to the right, two to the left or right.*

### Group challenge

Give each group a collection of beads of different colours and sizes and ask them to use up as many of the beads as they can to make the longest possible pattern. The same sequence must repeat itself over and over at least 4 times. Groups can then compare their patterns and count how many beads they used in total.

### Building shape patterns

Learners can use shape pieces to make the same kinds of patterns. They can name the shapes they use and describe the way they change position. For example:



I used circles and triangles, but my triangles point different ways. First it points left, then up, then right, then down, then left again.



### Rotational patterns

Ask learners to investigate and make patterns that use the same shape in different orientations.

Start by giving them an example of a rotating pattern, showing them how the shape does a full turn around its own axis. This is an informal introduction to transformations that learners look at more closely in Grade 4.



Talk about the pattern together and let learners describe how the shape moves each time. Ask them to predict which way the arrow will point next. Let them then use shapes or cut-out arrows to make their own rotational patterns. Then ask them to describe the direction of the turn each time. Encourage vocabulary like facing up or down, to the left or to the right.

Follow up with written activities where learners have to draw their own rotational patterns and also use worksheets with incomplete patterns that they must complete.

### Examples:

Draw the 3 arrows that come next in the pattern.



Which arrow goes next?



Is it A, B or C?    A     B     C 

### Growing patterns and number relationships

Design a worksheet with examples of patterns that 'grow' in different ways.

For example:



The number of flowers increases by 2 starting with 1, producing a sequence of odd numbers.



The number of flowers increases by 2 starting with 2, producing a sequence of even numbers.



This is a doubling pattern starting with 1.

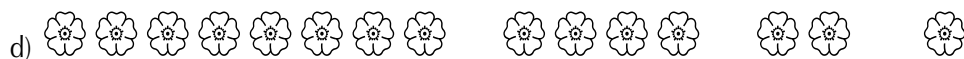

This is a halving pattern starting with 8.

To help learners uncover the rules for themselves, let them start by counting the number of flowers in each group of the pattern. Ask questions like, "How many flowers in the first group, the second, the third...?". Now have them write the numbers under each group and then see if they can explain each rule, based on the number patterns that they see.



Have them then predict how many flowers will be in the next group or in some cases, in the group that comes before the first one shown.

From here they can extend the pattern further by writing out the number pattern, without drawing more flowers:

1; 3; 5; 7; 9; 11; 13; 15; 17; ...

2; 4; 6; 8; 10; 12; 14; 16; 18; ...

1; 2; 4; 8; 16; 32; 64; ...

## Grade 3: Patterns, functions and algebra

### Decreasing patterns

- Next give them similar examples of images where the number patterns show change in a decreasing order. For example:

#### Pattern A:



This pattern begins with 9 and decreases by 2 each time – odd number sequence.

#### Pattern B:



This pattern begins with 12 and decreases by 2 each time – even number sequence.

#### Pattern C:



This is a halving pattern.

Let learners write to appropriate numbers under each group of objects. This will help them to decode the patterns.

Ask them to say how many wheels would come one or two places *before* the first group shown. They can also extend each pattern, this time by writing the numbers only rather than drawing the pictures.

Now let learners draw their own patterns or use counters or objects to make patterns, where the number of images either increase or decrease in regular intervals. Encourage them to talk about the different patterns. They should try to make and explain predictions about how many objects come before or next in a sequence. In this way you will help them to develop the vocabulary they need to describe the patterns using the numbers in each 'group' and their position in the sequence.

Learners can then use counters or similar objects to make up their own patterns, write them down as number patterns and explain the rule for each pattern they make. Ask them how they would extend their patterns if they were to continue them from either end.

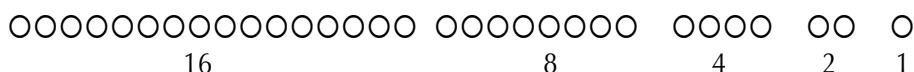

"So how many counters will you need to build the number that comes before 16?" (32)

"And the one before that?" (64)

"On the other side of the pattern, what number comes after 1?" ( $\frac{1}{2}$ )

### Patterns on grids

Give learners grid paper to design their own examples of increasing and decreasing patterns.

They can also use dots, crosses or other symbols in the grids.

Give them chances to explain their patterns to the rest of the class.

"My pattern grows like this: I shaded 1 block and 2 blocks, and then I skipped a row and shaded 2 blocks and 3 blocks, skipped again, then 3 and 4 blocks."

"So how will you continue your pattern?"

"First I will skip a row then I will shade 4 blocks, then 5 blocks next to each other. "

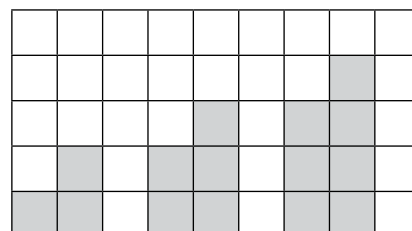

## Grade 3: Patterns, functions and algebra

Ask the learners to write numbers to match their patterns. For example:

1	2		2	3		3	4		4	5

### Numbering positions in the pattern

Introduce learners to ways of naming the position of each part of a pattern in a sequence.

Sometimes the position number may be the same as the number of elements in the pattern and sometimes not. For example, here the number of elements in the pattern matches the position number:

1	2	3	4
♥	♥♥	♥♥♥	♥♥♥♥
Position 1	Position 2	Position 3	Position 4

In this example, the position number is 2 less than the number of elements in the pattern.

3	4	5	6
♥♥♥	♥♥♥♥	♥♥♥♥♥	♥♥♥♥♥♥
Position 1	Position 2	Position 3	Position 4

Ask learners to compare the two patterns by looking at the number of elements and the matching position number. See if they can then make a rule for the pattern by predicting numbers and position numbers beyond those shown in the example.

“So tell me about the **first pattern**, what do you notice?”

“So how many hearts for position number 10?”

“And if you go on to position number 121, how many hearts will you need?”

“And what about the **second heart pattern**?”

(There are 3 hearts for position 1, 4 for position 2, 5 for position 3 ... so that means the position number is 2 less than the number of hearts.)

“So how many hearts will you need to draw for position number 5?”

(2 more than 5, so that makes 7 hearts.)

“And for position number 135?” (137)

Give learners practice making up their own patterns by drawing shapes or pictures or using counters or other concrete apparatus. They should show examples where the position number is the same as the number of elements and examples where the position number is less than the number of elements. Make time for them to discuss and compare their patterns. Ask questions that help learners to predict the number of elements that come before and after the given pattern. This leads them to develop with rules for the different patterns they create.

### Skills and knowledge

#### The learner:

- Copies and extends simple patterns using physical objects and drawings (e.g. using colours and shapes).
- Copies and extends simple number sequences to at least 100.
- Creates own patterns.
- Describes observed patterns.

### Suggested activities

#### Introducing number patterns

From Grade 3 learners should know and be able to read and write number symbols from 1 to 1 000. To fully understand these numbers, learners must investigate the repeating and expanding number cycles and patterns we use to form, give value to, sequence and write numbers. In particular, they must come to understand how we combine numbers in groups of 10, and in multiples of 10; and how we use placing patterns to label these groups and to show the value of each digit in the number. So, for example, they must understand that in the numbers 2, 20, 200 and 2 000, the amount that the 2 stands for changes according to where we place it in the number.

Investigating number patterns should be integrated with other number work. Activities for counting forwards and backwards in different number groups, sequencing, ordering and writing numbers, grouping them in different ways and doing number calculations all involve number patterns. Training learners to observe and use patterns as they work will help them to develop a deeper number sense and gain confidence when manipulating numbers and exploring number relationships.

### Counting patterns

As your learners become more and more numerate, they can explore number patterns within an extended number range of 1 to 1 000. They can also explore fraction patterns and time patterns. Let's review some of the common kinds of number patterns we want them to explore.

#### Repeating patterns

222; 223; 224; 222; 223; 224; \_\_\_\_; \_\_\_\_; \_\_\_\_

567; 565; 564; 567; 565; 564; \_\_\_\_; \_\_\_\_; \_\_\_\_

The group of 3 numbers repeats each time.

#### Growing patterns

130; 140; 150; 160

The numbers increase by 10 each time.

522; 524; 526; 528

The numbers increase by 2 each time.

199; 198; 197; 196

A growing pattern, even though the numbers decrease in size.

13; 26; 52; 104; 208

A doubling pattern that 'grows'.

480; 240; 120; 60; 30; 15

A halving pattern that 'grows'.

#### Place value patterns

As learners learn to count forwards and backwards from 1 to 1 000, help them to see that there is both a *growing* pattern in the 10s digits and a *cyclical repeating* pattern in the 1s digits.

121; 122; 123; 124; 125; 126; 127; 128; 129; 130; 131; 132; 133; 134; 135; 136; 137; 138.

Encourage learners to make this discovery on their own by looking at how the values of the digits change, as the numbers increase in size.

Or they may decrease in size:

140; 139; 138; 137; 136; 135; 134; 133; 132; 131; 130; 129; 128; 127; 126; 125; 124; 123; 122; 121.



# Grade 3: Patterns, functions and algebra

## Number board patterns

Give learners practice looking for place value patterns on their number grids. Start by using blank number boards.

401									

Write the number 401 in the first block. Count on across the rows. Write in the numbers as you count. Carry on until you get to 500.

Check with your friends to see that you both have the same numbers. Now let's see what patterns we get when we go across the rows ...and now let's count down the rows.



I see some pattern!  
The last digit in each row always ends in 0. The middle digit of each number changes in each row going down. The 1s always go up from 1 to 9 and then end with 0. The hundreds digit only changes when you get to the last block for 500.

## Counting patterns on the number board

Now use number boards with the numbers written in. Begin by having learners read and point to the numbers as they say them.

101	102	103	104	105	106	107	108	109	110
111	112	113	114	115	116	117	118	119	120
121	122	123	124	125	126	127	128	129	130
131	132	133	134	135	136	137	138	139	140
141	142	143	144	145	146	147	148	149	150
151	152	153	154	155	156	157	158	159	160
161	162	163	164	165	166	167	168	169	170
171	172	173	174	175	176	177	178	179	180
181	182	183	184	185	186	187	188	189	190
191	192	193	194	195	196	197	198	199	200

When you count across you add 1 each time so the 1s digits get bigger.

When you count down, you are counting in 10s, so the 10s digit gets bigger and the 1s digits stay the same.



Make a worksheet where you show only one or two rows or columns of the board. Let learners investigate which digits and values stay the same and which change when they read the numbers across the rows.

101	102	103	104	105	106	107	108	109	110
111	112	113	114	115	116	117	118	119	120

101	102
111	112
121	122
131	132
141	142
151	152
161	162
171	172
181	182
191	192

and then down the rows....

Ask learners to draw the next row or the next column of numbers, without looking back to their number boards, but by following the pattern of the first two rows and columns on the worksheet.

Using crayons, learners can shade blocks in different groups of numbers and then describe the patterns they see. For example:

- All the numbers with a 5 in them.
- All the numbers with an 8 in them.
- All the numbers with a 3 in them.

101	102	103	104	105	106	107	108	109	110
111	112	113	114	115	116	117	118	119	120
121	122	123	124	125	126	127	128	129	130
131	132	133	134	135	136	137	138	139	140
141	142	143	144	145	146	147	148	149	150
151	152	153	154	155	156	157	158	159	160
161	162	163	164	165	166	167	168	169	170
171	172	173	174	175	176	177	178	179	180
181	182	183	184	185	186	187	188	189	190
191	192	193	194	195	196	197	198	199	200

Ask questions like:

“Which numbers are in both patterns?”

“What will the pattern look like for all the numbers with a 2 or a 3 in them?”

## Subtracting along the diagonals

Ask learners to draw a block around any 4 numbers on the number board to make a 2 x 2 grid like the one below. They must then calculate the difference between the numbers along both diagonals as shown by the arrows.

When you start from the bottom left hand block and subtract the top right hand block, the difference is 9.



And when you subtract the top left hand block from the bottom right hand block, the answer is 11.

## Diagonal patterns

184	185
194	195

Have them do this at least 2 more times for two different 2 x 2 grids. They will find that the differences will always be the same. Ask them to think about why this is so and to explain their reasoning.

For 9, you go one block up, so that's 10 less and then one block to the right, so that makes 9 less, and the blocks are arranged in the same order for all the numbers, so it will always be 9.



And for 11, you go up one block, that's 10 and one to the left, so that always makes 11.

## Adding along the diagonals

Ask learners to add up the numbers on the diagonals of any 2 x 2 grid.

For example: (162 + 173 = 335) and (163 + 172 = 335). Let them do this for at least 3 examples and then explain why they always get the same total. The investigation will also give them practice adding 3-digit numbers.

162	163
172	173

Well, going from left to right there's one less in the top number than the bottom number and going from right to left, there's one more in the top number than the bottom number, so it evens out that way.



## Grade 3: Patterns, functions and algebra

### Odds and evens

Use the number boards and counters to investigate odds and evens.

When counting in 2s, let learners start from zero and place counters on alternate numbers as they say the names of the numbers they cover. Once they begin to see the patterns, ask them to predict how the counting sequence will continue. Ask guiding questions to help learners make their own rules for counting in 2s when we start at zero. It could be something like, "I notice that the numbers always end in a 2, a 4, a 6, an 8 or a zero."

Repeat the counting in 2s activity. This time let learners find and predict the pattern for when they start from 1. Ask guiding questions to help them make their own rules for counting in 2s for when we start with 1.

Once learners can give you rules for counting in 2s (starting either from zero or from one), you can introduce the terms 'even' and 'odd' numbers to describe the numbers they covered on the board. When they started from 0, the numbers were even and when they started from 1, the numbers were odd. You can reinforce this work with work cards like these:

Use your pattern for **odd** numbers.

Circle all the **odd** numbers.

2 5 10 17 18 29 35 72 81  
102 104 125 177 183 192 199

Explain to your friend why you circled these numbers.

Use your pattern for **even** numbers.

Circle all the **even** numbers.

2 5 10 17 18 29 35 72 81  
102 104 125 177 183 192 199

Explain to your friend why you circled these numbers.

### Skip counting on the number board

By Grade 3, learners should be able to count on (skip count) in groups of 2s, 5s, 10s, 20s, 25s, 50s and 100s. They should also know their multiplication facts for numbers up to 50. This means that they should practise skip counting in other number groups that give a product of up to 50. Of course they can also go beyond this and cover all numbers from 1 to 100.

Make enough copies of number boards from 1 to 100 and from 101 to 200 so that learners can do different skip counting activities. They can first count on in different groups, using counters to cover the numbers as they count them, and then shade the numbers they count. As they go along, they should look for patterns for one group of numbers and then compare patterns for different groups.

Beginning with the 10s pattern, their boards will look like this:

1	2	3	4	5	6	7	8	9	10
11	12	13	14	15	16	17	18	19	20
21	22	23	24	25	26	27	28	29	30
31	32	33	34	35	36	37	38	39	40
41	42	43	44	45	46	47	48	49	50
51	52	53	54	55	56	57	58	59	50
61	62	63	64	65	66	67	68	69	70
71	72	73	74	75	76	77	78	79	80
81	82	83	84	85	86	87	88	89	90
91	92	93	94	95	96	97	98	99	100

101	102	103	104	105	106	107	108	109	110
111	112	113	114	115	116	117	118	119	120
121	122	123	124	125	126	127	128	129	130
131	132	133	134	135	136	137	138	139	140
141	142	143	144	145	146	147	148	149	150
151	152	153	154	155	156	157	158	159	160
161	162	163	164	165	166	167	168	169	170
171	172	173	174	175	176	177	178	179	180
181	182	183	184	185	186	187	188	189	190
191	192	193	194	195	196	197	198	199	200

## Grade 3: Patterns, functions and algebra

For the 5s pattern, their boards will look like this:

1	2	3	4	5	6	7	8	9	10
11	12	13	14	15	16	17	18	19	20
21	22	23	24	25	26	27	28	29	30
31	32	33	34	35	36	37	38	39	40
41	42	43	44	45	46	47	48	49	50
51	52	53	54	55	56	57	58	59	60
61	62	63	64	65	66	67	68	69	70
71	72	73	74	75	76	77	78	79	80
81	82	83	84	85	86	87	88	89	90
91	92	93	94	95	96	97	98	99	100

101	102	103	104	105	106	107	108	109	110
111	112	113	114	115	116	117	118	119	120
121	122	123	124	125	126	127	128	129	130
131	132	133	134	135	136	137	138	139	140
141	142	143	144	145	146	147	148	149	150
151	152	153	154	155	156	157	158	159	160
161	162	163	164	165	166	167	168	169	170
171	172	173	174	175	176	177	178	179	180
181	182	183	184	185	186	187	188	189	190
191	192	193	194	195	196	197	198	199	200

For the 2s pattern:

1	2	3	4	5	6	7	8	9	10
11	12	13	14	15	16	17	18	19	20
21	22	23	24	25	26	27	28	29	30
31	32	33	34	35	36	37	38	39	40
41	42	43	44	45	46	47	48	49	50
51	52	53	54	55	56	57	58	59	60
61	62	63	64	65	66	67	68	69	70
71	72	73	74	75	76	77	78	79	80
81	82	83	84	85	86	87	88	89	90
91	92	93	94	95	96	97	98	99	100

101	102	103	104	105	106	107	108	109	110
111	112	113	114	115	116	117	118	119	120
121	122	123	124	125	126	127	128	129	130
131	132	133	134	135	136	137	138	139	140
141	142	143	144	145	146	147	148	149	150
151	152	153	154	155	156	157	158	159	160
161	162	163	164	165	166	167	168	169	170
171	172	173	174	175	176	177	178	179	180
181	182	183	184	185	186	187	188	189	190
191	192	193	194	195	196	197	198	199	200

Ask questions to help them think about the different patterns they get, to compare the patterns for different groups, to find which numbers occur in more than one group and to make rules for each pattern. They can also predict if bigger numbers, up to 1 000, that are not shown on the boards, fit a particular pattern or not.

For example:

“What digits do the numbers in the 10s pattern always end with?”

“What digits do the numbers in the 5s pattern always end with?”

“Which numbers are both in the 10s pattern and the 5s pattern?” (*the multiples of 10*).

“Which number comes next in the 10s or 5s pattern after 200? After 300? After 900?”

“What digits do the numbers in the 2s pattern always end with?”

“Write the next 4 numbers in the 2s pattern after 200. After 300? 500?”

“Busi says the number 346 is in the 5s pattern. Is she correct?” “How do you know?”

“Mahmud says 560 is in the 5s and the 10s pattern. “Is he correct?” “How do you know?”

“Susan says the number 45 689 cannot be in the 2s pattern. “How does she know?”

“Write a number with 5 digits that is in the 2s pattern. Explain how you know.”

### The 4s pattern

On a new number grid, have learners count on in 4s and shade all the numbers in the 4s pattern. You can choose to go up to 48, or let them count on in 4s up to 100.

Ask questions like:

“Are the numbers in the 2s pattern also in the 4s pattern?”

“Which ones are missing from the 4s pattern?”

(All the white blocks that are even numbers are in the 2s pattern, but not in the 4s pattern.)

“Are the numbers in the 4s pattern also in the 2s pattern?”

(The 4s pattern always ends with even numbers, just like the 2s pattern.)

1	2	3	4	5	6	7	8	9	10
11	12	13	14	15	16	17	18	19	20
21	22	23	24	25	26	27	28	29	30
31	32	33	34	35	36	37	38	39	40
41	42	43	44	45	46	47	48	49	50
51	52	53	54	55	56	57	58	59	60
61	62	63	64	65	66	67	68	69	70
71	72	73	74	75	76	77	78	79	80
81	82	83	84	85	86	87	88	89	90
91	92	93	94	95	96	97	98	99	100

## Grade 3: Patterns, functions and algebra

### The 8s pattern

From here, learners can count on in 8s on the same board. They must use a darker shade to colour the numbers in the 8s pattern so that their boards look like this:

Ask questions to help them see that every 2<sup>nd</sup> number in the 4s pattern is in the 8s pattern and that the numbers in both the 8s pattern and the 4s pattern are always even. This means that all the numbers in the 8s pattern are also in the 2s pattern.

1	2	3	4	5	6	7	8	9	10
11	12	13	14	15	16	17	18	19	20
21	22	23	24	25	26	27	28	29	30
31	32	33	34	35	36	37	38	39	40
41	42	43	44	45	46	47	48	49	50
51	52	53	54	55	56	57	58	59	60
61	62	63	64	65	66	67	68	69	70
71	72	73	74	75	76	77	78	79	80
81	82	83	84	85	86	87	88	89	90
91	92	93	94	95	96	97	98	99	100

### The 3s pattern

Ask learners to now count on in 3s and to use a light colour to shade all the numbers that fall in the pattern. Talk about the diagonal arrangement of numbers in the 3s pattern.

1	2	3	4	5	6	7	8	9	10
11	12	13	14	15	16	17	18	19	20
21	22	23	24	25	26	27	28	29	30
31	32	33	34	35	36	37	38	39	40
41	42	43	44	45	46	47	48	49	50
51	52	53	54	55	56	57	58	59	60
61	62	63	64	65	66	67	68	69	70
71	72	73	74	75	76	77	78	79	80
81	82	83	84	85	86	87	88	89	90
91	92	93	94	95	96	97	98	99	100

Using a darker shade, have them now shade those numbers that are in both the 2s and the 3s pattern.

1	2	3	4	5	6	7	8	9	10
11	12	13	14	15	16	17	18	19	20
21	22	23	24	25	26	27	28	29	30
31	32	33	34	35	36	37	38	39	40
41	42	43	44	45	46	47	48	49	50
51	52	53	54	55	56	57	58	59	60
61	62	63	64	65	66	67	68	69	70
71	72	73	74	75	76	77	78	79	80
81	82	83	84	85	86	87	88	89	90
91	92	93	94	95	96	97	98	99	100

What can you tell me about the numbers that are in both patterns?



They are even numbers.

And why is that?



Because if they're in the 2s pattern they have to be even, so if they are in both patterns, they can only be even, not odd.

### The 6s pattern

On the same board, let learners count on in 6s and see which numbers they land on. Ask similar questions to the ones for other patterns.

Sum up by asking questions like:

- So are all the numbers in the 6s pattern also in the 2s and 3s pattern? (Yes).
- Are all the numbers in the 3s pattern also in the 6s pattern? (No, only the even ones).
- Are all the numbers in the 2s pattern also in the 6s pattern? (No, only some of them).

### The 9s pattern

Now let learners shade all the numbers in the 9s pattern and explain that they run in a diagonal line from right to left. After that they can shade the numbers in the 11s pattern that produces a diagonal line in the opposite direction.

Talk about the different numbers learners get for each pattern.

Ask them to add the digits in each of the numbers in the 9s pattern. They will find that these digits always add up to 9 or a number in the 9s pattern.

For example:

for 63:  $6 + 3 = 9$ ;

for 81:  $8 + 1 = 9$ .

They can use this rule to answer questions like:

“Which of these numbers are in the 9s pattern? How do you know?”

162; 189; 972; 456; 207

(They are all in the 9s pattern, except 456 because  $5 + 4 + 6 = 15$  and 15 is not in the 9s pattern)

For the 11s pattern, for 2 digit numbers, the same digit repeats itself, so if they add the digits together they will get double the value of the repeating digit ( $3 + 3 = 6$ ) or ( $4 + 4 = 8$ ).

### Written practice

Once learners have done lots of work with the number boards, and can read and say the numbers in the different patterns, give them written exercises to consolidate what they have learned. Use examples where they have to extend a pattern that you start for them, fill in missing numbers left out in a sequence or identify numbers that don't belong in a given pattern sequence.

a) 110; 120; 130; \_\_\_; \_\_\_; \_\_\_     *Extending the pattern*

b) Write all the numbers in the 10s pattern between 120 and 190.

*Writing a pattern sequence in a given range.*

c) 120; \_\_\_; 140; \_\_\_; 160; \_\_\_; 180; \_\_\_

*Find the missing numbers.*

d) 120; 130; 140; 150; 160; 170; 180; 185; 190; 200

Circle the number that does not belong.

e) Which of these numbers is in the 2s, 5s and 10s pattern?

125; 132; 140; 164

*Finding patterns that converge*

f) Which of these numbers is in the 10s pattern?

134; 450; 655; 789

*Generalising the pattern to larger numbers.*

Give learners lots of practice examples that cover the 2s, 5s and 10s patterns.

Design different work cards or worksheets to help learners practise and become very familiar with all these patterns. Important principles to remember are:

- Let learners who still need support, use aids to build and check their ideas.
- Encourage confident learners to work mentally and use ever increasing numbers – beyond 100.

1	2	3	4	5	6	7	8	9	10
11	12	13	14	15	16	17	18	19	20
21	22	23	24	25	26	27	28	29	30
31	32	33	34	35	36	37	38	39	40
41	42	43	44	45	46	47	48	49	50
51	52	53	54	55	56	57	58	59	60
61	62	63	64	65	66	67	68	69	70
71	72	73	74	75	76	77	78	79	80
81	82	83	84	85	86	87	88	89	90
91	92	93	94	95	96	97	98	99	100



## Grade 3: Patterns, functions and algebra

### Doubling and halving patterns on the number board

You can also use number boards to help learners develop their understanding of 'doubling and halving'. For example, let them put a counter on the board, say on the 2, then keep on doubling the number they land on (2, 4, 8, 16, etc). Some learners may need to put out the actual number of counters on their desks and double them every time before they will be able to double on the number board alone.

Let learners reverse the pattern by halving repeatedly to develop the understanding that doubling and halving reverse each other.

### Number name and place value patterns

Once learners start to write numbers, we need to help them build an understanding that there is a big change in the way we write numbers when we go beyond 9. Up to 9, we simply use a new digit symbol and give each number a new name. After 9, we group in tens, and multiples of ten, to form the numbers. We also use placing patterns to write numbers.

So, we want learners to know that:

- the digits in numbers from 10 to 19 stand for one group of 10 plus a number of 'singles' that are not enough to make up another ten.  
 $11 = 10 + 1$ ;  $12 = 10 + 2$ ; ...  $19 = 10 + 9$
- the digits in numbers from 20 to 29 stand for 20 (two groups of ten) plus a number of 'singles' that do not make up another ten.  
 $21 = 20 + 1$ ;  $22 = 20 + 2$ ; ...  $29 = 20 + 9$
- the numbers from 30 to 39 stand for 30 (three groups of ten) plus a number of 'singles' ( $37 = 30 + 7$ ) and so on.

Once learners understand these patterns, counting becomes easier. Up to 100, learners need to learn only eight new number names (twenty, thirty, forty ... to ninety).

These names are easy because there are patterns ('ty' after the number of tens, e.g. six-ty). There are regular patterns for all the 'in-between' numbers (twenty-one, twenty-two etc).

### Grouping patterns

Skip counting lays the foundation for working with number groups and doing calculations that involve both grouping and sharing (multiplication and division). By identifying numbers that belong to both patterns, learners build an intuitive understanding of the commutative nature of multiplication. For example:

1	2	3	4	5	6	7	8	9	10
11	12	13	14	15	16	17	18	19	20
21	22	23	24	25	26	27	28	29	30

The lightest shaded blocks show that 15 and 30 are in both the 3s and the 5s pattern .

When counting on in 3s, you find that 3 counted 5 times is 15.

Or  $5 \times 3 = 15$



And when counting on in 5s, you find that 5 counted 3 times is 15.

Or  $3 \times 5 = 15$



## Grade 3: Patterns, functions and algebra

After finding which numbers fall in more than one group, learners can show the same numbers (multiples) using counters or by shading blocks in a grid. They must have the same number of dots or counters in each row. Here is an example:

### Some representations of 48

Ask learners to write multiplication number sentences for each 'array' and to find the matching pairs for each pattern. i.e.  $8 \times 6$  and  $6 \times 8$ ;  $12 \times 4$  and  $4 \times 12$ ;  $16 \times 3$  and  $3 \times 16$ .

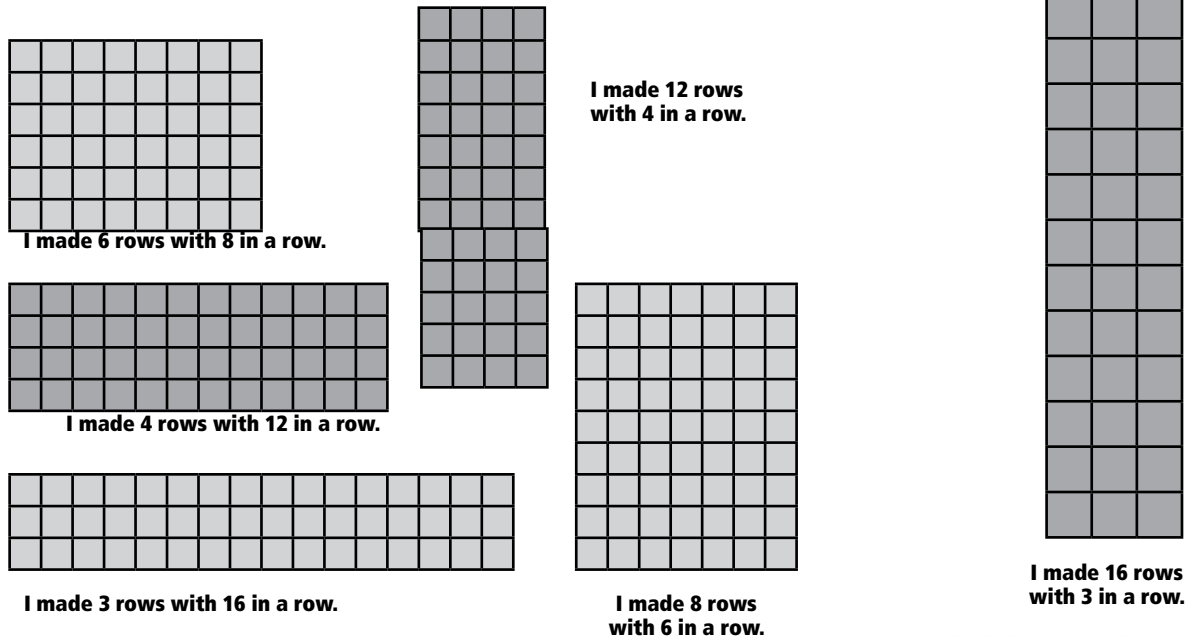

### Addition and

### subtraction patterns

As learners begin to see more patterns and number relationships, they can use this knowledge to operate with numbers more efficiently. Design work cards with lots of different examples.

Work cards are useful because you can adapt the text book activities to meet your own learners' needs. You can also design work of different difficulty levels for learners who are functioning at different levels. Learners can also choose whether they need the support of concrete aids to help them complete the work cards, or whether they are able to work mentally. According to the needs of your different learners:

- make the worksheets shorter or longer;
- use bigger or smaller numbers;
- use other patterns.

In these examples, learners practise adding and subtracting the same number.

They use 'pattern thinking' to find quick answers.

$$\begin{aligned} 100 - 75 &= 25 \\ 200 - 75 &= 125 \\ 300 - 75 &= 225 \\ 400 - 75 &= 325 \\ 500 - 75 &= 425 \end{aligned}$$

$$\begin{aligned} 500 + 50 &= 550 \\ 600 + 50 &= 650 \\ 700 + 50 &= 750 \\ 800 + 50 &= 850 \\ 900 + 50 &= 950 \end{aligned}$$

$$\begin{aligned} 900 - 25 &= 875 \\ 800 - 25 &= 775 \\ 700 - 25 &= 675 \\ 600 - 75 &= 575 \\ 500 - 25 &= 475 \end{aligned}$$

$$\begin{aligned} 100 + 150 &= 250 \\ 200 + 150 &= 350 \\ 300 + 150 &= 450 \\ 400 + 150 &= 550 \\ 500 + 150 &= 650 \end{aligned}$$

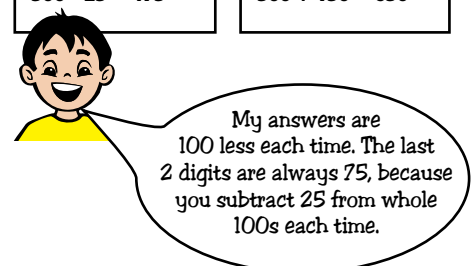
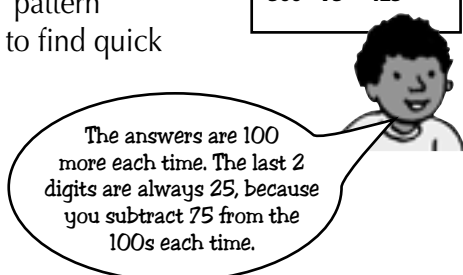

## Grade 3: Patterns, functions and algebra

### Commutative patterns

Give examples that help learners to see patterns in the relationship between adding and subtracting, using the same set of numbers. In other words, learners begin to explore commutative relationships in patterns.

For example:  $40 + 50 = 90$   
 $50 + 40 = 90$   
 $90 - 40 = 50$   
 $90 - 50 = 40$

Start with small numbers like these, and talk about the different ways we can combine the numbers by following the pattern.

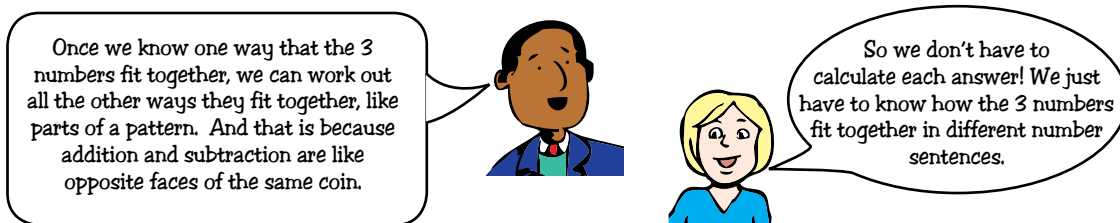

Give practice examples using bigger numbers up to 1 000 to build learners' number skills.

$$560 + 20 = \square$$
$$20 + 560 = \square$$
$$580 - 20 = \square$$
$$20 + 560 = \square$$

Also change the position of the unknown in the number sentence.

For example:  $560 + \square = 580$   
 $20 + 560 = \square$   
 $\square - 20 = 560$   
 $580 - \square = 560$

### Recursive patterns

#### Pascal's Triangle

This is an example of a recursive pattern, when the outcome of a step depends on the outcome of a previous step. The triangle itself is made by arranging numbers. Each number in the triangle is the sum of the pair of numbers directly above it, to the above left and above right. The first four rows are as follows (the 1 at the top is considered to be Row 0):

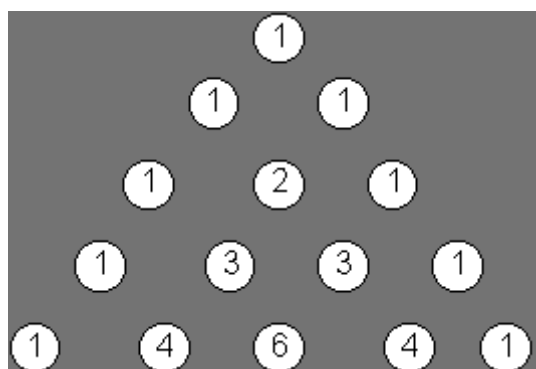

Start by giving the completed top part of the triangle to your learners. Ask them to work out the pattern we use to fill in the numbers in the triangle. Once they have worked this out, see if they can complete the next five rows of the triangle.

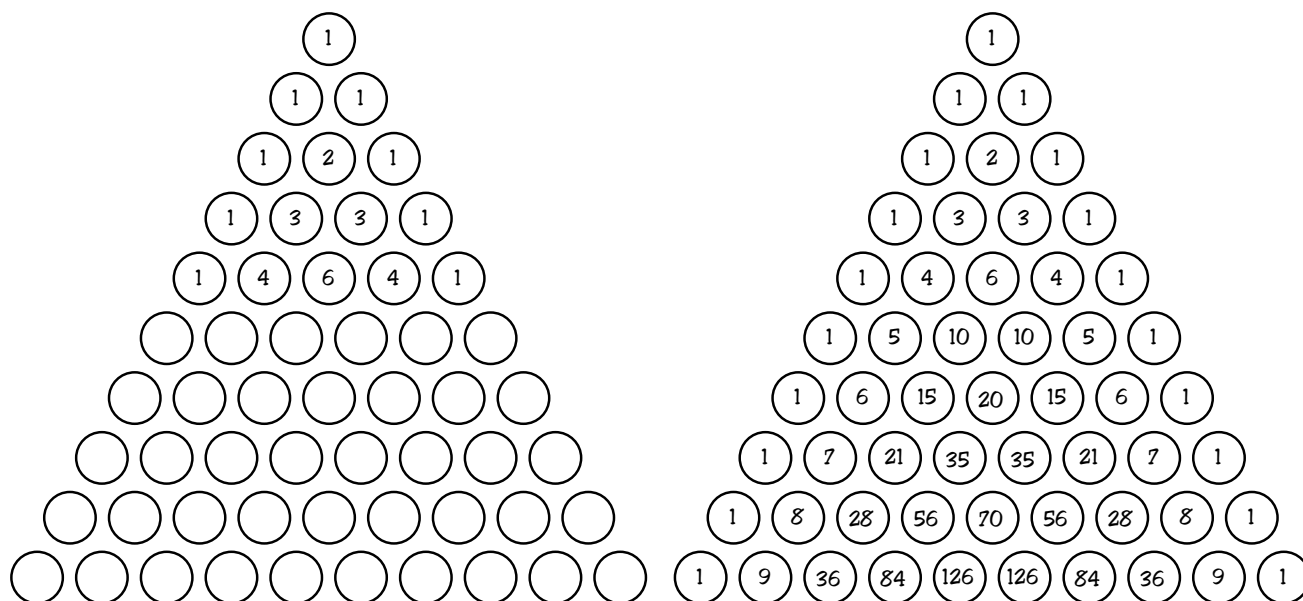

When the children have completed all the rows, help them look for more patterns. For example, along the diagonals going from left to right and right to left, even and odd numbers and totals of the numbers in each row, which they can add using their calculators.

**Fibonacci number sequence**

A long time ago, a man called Fibonacci discovered a very interesting number pattern, which is now called the Fibonacci sequence. Here is the pattern:

1    1    2    3    5    8    13    21    34

Ask learners to see if they can work out the pattern for themselves and to calculate which the next 3 numbers will be in the pattern. They can then use their calculators to work out further numbers in the sequence. They should check each other as they go along - if one number is incorrect, all the next numbers will also be incorrect.

The pattern is easy to work out. To make the next number in the pattern, all you have to do is add together the last two numbers.

1    1    2    3    5    8    13    21    34  
                   1 + 1 = 2    1 + 2 = 3    2 + 3 = 5    3 + 5 = 8    5 + 8 = 13    8 + 13 = 21    13 + 21 = 34

**Kaprekar's sequence**

**Reversing the digits**

This is another number sequence that your Grade 3 learners can investigate. It produces some interesting patterns. They should follow each step and carry on the process, looking for patterns as they work.

1. Think of a two-digit number	28
2. Reverse the digits	82
3. Take the smaller number from the larger number	82 - 28 = 54
4. Use this answer. Go back to step 2 and repeat steps 2 and 3 over and over again until you see the pattern.	54 - 45 = 09 90 - 09 = 81 81 - 18 = 63 ...

## Grade 3: Patterns, functions and algebra

Help learners to see the links the pattern has with the 9 times table.

Ask learners if there are any numbers for which Kaprekar's sequence does not work (numbers with two digits which are the same - 11, 22, 33 etc.). Why do they think this is the case?

Ask them to test the sequence using three digit numbers. Do they get the same pattern?

### Finding the rules

Give examples of number sequences where the variable changes every two steps and ask learners to work out if they can find the rules and also work out what the next 3 or 4 numbers will be in the pattern. Then let them make up similar patterns of their own and ask their partners to work out the rules and extend the number sequences, either from the front or the back. Here are some examples:



**The rule is:**

**double then add 1**



**The rule is:**

**take away 3  
then add 4**

### Magic square patterns

A magic square is an arrangement of numbers in a grid, where each number occurs exactly once. The sum of the numbers, the "magic number", of any row, any column, or any main diagonal is the same.

Give learners examples, beginning with 3 x 3 grids, where they have to work with the numbers they're given to find the magic number. Then they can do ones where they have to find the magic number or pattern and also fill in the missing numbers, once they have worked out the pattern.

1	6	5
8	4	0
3	2	7

7	8	3
2	6	10
9	4	5

**In each square find the magic number.**

6		8
	5	3
	9	4

6	5	
11		3
4	9	

**Use the magic number to fill in the missing numbers.**

## Square number patterns

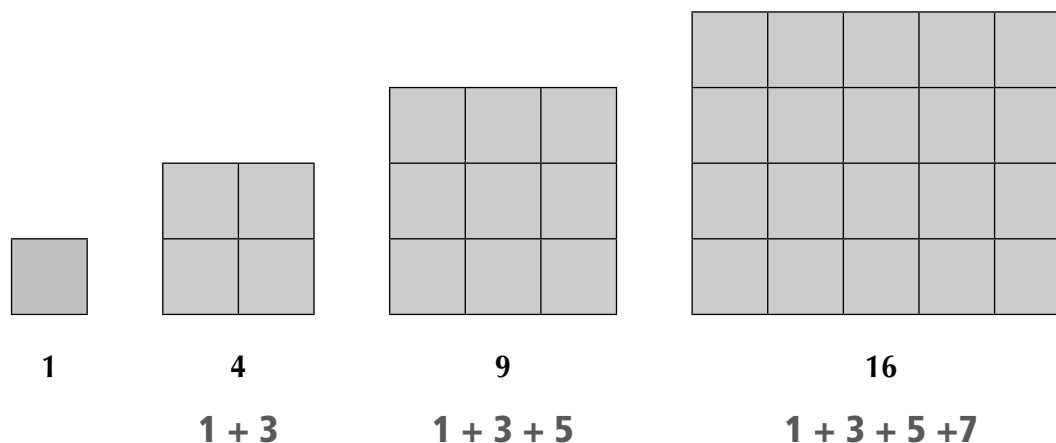

First talk about squares. What makes a square a square?

Is a square also a rectangle? Why? Why not?

Next ask learners to draw squares of increasing sizes on grid paper as shown above. They must then look for patterns in the number of blocks they need to shade each time. Also ask them to find a pattern in the number of blocks they need to add to the previous square each time.

Have them then draw the next two or 3 squares in the series to check they are following the pattern. Thereafter, without drawing the blocks, let them use the number pattern to work out how many blocks they will use for the next 5 or 6 squares in the pattern.

## Triangular Numbers

Triangular numbers are numbers of objects or symbols we use to make a series of 'triangles' of increasing size.

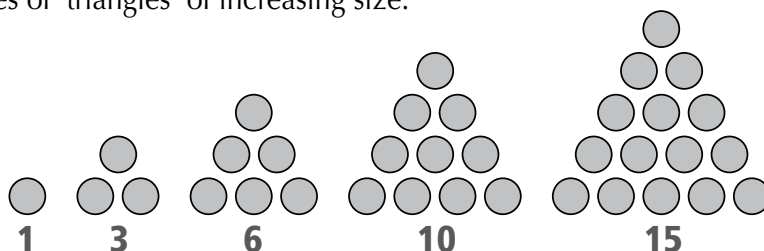

Learners can draw dots or use round counters to build the numbers.

Have them count the numbers of dots they use each time and discuss why we call these triangular numbers. They should look for patterns. For example, how many dots do we add each time to the last row to build the next sized triangle in the series?

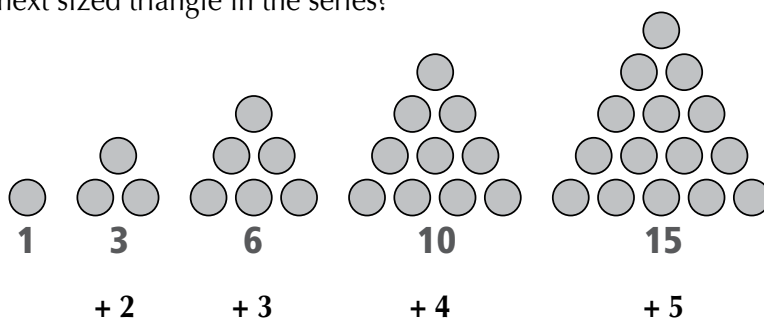

From this pattern ask them to now predict how many dots they will need to build the next triangular number, and the next?



## Grade 3: Patterns, functions and algebra

### The maths behind the trick

You will need counters or beans.



#### The Secret Number Trick

Think of a secret number.

Add 7.

Multiply the result by 2.

Subtract 6.

Divide by 2.

Subtract your secret number.

Now tell me your answer and I'll tell you the secret number.



What's the secret to this trick? To solve the mystery we are going to solve an algebraic equation. You know that algebra forms the foundation for all higher maths and that is very useful in many fields including science, engineering, business and economics. But did you know you can solve algebraic equations with counters and beans?

In algebra we use symbols to represent unknown quantities. We are going to use a counter to represent the secret number.	
And we'll use beans to represent the numbers we know. So our secret number plus 7 looks like this:	
The next step is to multiply by 2.	
And then we subtract 6, which might look like this:	
Next we have to divide by 2. In other words, take away half of what we have. What do we have now?	

The instructions say, "Tell me your answer and I will tell you the secret number." How do we do that?

Use your counters and beans to find the maths secret behind these number tricks:

<p><b>Secret Number Trick 1</b></p> <p>Think of a secret number.</p> <p>Add 5.</p> <p>Multiply by 2.</p> <p>Add 2.</p> <p>Divide by 2.</p> <p>Tell me your answer and I will tell you the secret number.</p>	<p><b>Secret Number Trick 2</b></p> <p>Think of a secret number.</p> <p>Add 12.</p> <p>Subtract 5.</p> <p>Add 7.</p> <p>Subtract 13.</p> <p>Tell me your answer and I will tell you the secret number.</p>
--	--

Learners should realise that they must do all the steps in the secret number trick. Then they take away the answer they get from the answer their friend gives them. So in Trick 1:  $5 \times 2 = 10$ ,  $10 + 2 = 12$ ,  $12 \div 2 = 6$ . If the friend says her answer is 15, then the secret number is 9 ( $15 - 6$ ).

### Vocabulary

#### Grade 1, 2 and 3:

Repeating pattern; language to describe patterns, e.g. position words - right, left, first, second, last, next, the one before, the one after; shape and colour words; increase or grow, decrease or shrink; doubling; halving; rows and columns.

### Resources

Pictures of patterns in nature, in drawings, clothes, paving, houses etc; pattern posters if possible; musical instruments to make rhythm patterns; cut-out shapes for making patterns; beads, seeds, threading string etc; potato prints or stencils; paints; glue and scissors; coloured paper; counters; number dot cards; number cards; grid paper; number boards and blank number boards; weather charts, timetables, life cycle charts etc; gift wrapping paper or wall paper

# Grade 3: Space and shape (geometry)

The learner will be able to describe and represent characteristics and relationships between two-dimensional shapes and three-dimensional objects in a variety of orientations and positions.

## Skills and knowledge

### The learner:

- Recognises, identifies and names two-dimensional shapes and three-dimensional objects in the classroom and in pictures including:
  - a) boxes (prisms) and balls (spheres) and cylinders;
  - b) triangles squares and rectangles;
  - c) circles;
  - d) cones and pyramids.
- Describes, sorts and compares physical 2-D shapes and three-dimensional objects in pictures and in the environment including:
  - a) two-dimensional faces in or on the faces of three-dimensional objects;
  - b) flat/straight and curved /round surfaces and edges.
- Observes and creates given and described two-dimensional objects and three-dimensional objects using concrete materials (e.g. building blocks, constructions sets, cut-out two-dimensional shapes and three-dimensional objects, clay, drinking straws).

The vocabulary that learners need to understand and use for these skills is listed at the end of the suggested activities. You will find it helpful to make flash cards with key vocabulary words to support the teaching and learning process. A list of the resources you will need for the activities is also provided.

## Suggested activities

### Investigating 2-D shapes

#### Curved shapes

- Draw a large oval and a circle on the board. Ask learners to name both shapes and to talk about how they are the same and different. Using light coloured wax crayons, learners can practise drawing both shapes, using wide circular movements.



Don't focus on whether their figures are 100% accurate, but rather on whether learners are able to show the different kinds of 'roundness'.

- Make up a worksheet with the following shapes:

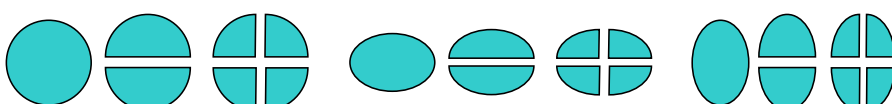

A **circle** is a perfectly formed round shape with one curved edge. Every point along the edge is the same distance from the centre.

An **oval** is also a round shape with one curved edge, but it narrows on either side, making the shape elliptical. The length from the centre to the edge is therefore not the same at different points around the circumference. It will help learners to understand more about the properties of circles by comparing them with other curved shapes like ovals.

The circle is curved the same way all around.

The oval is also curved and round, but it gets wider across one way and flatter the other way.

## Grade 3: Space and shape (geometry)

Ask learners to write down the number of shapes that are:

- circles
- half circles
- quarter circles
- ovals
- half ovals
- quarter ovals

You can ask questions that extend learners' fraction knowledge too. For example:

How many  $\frac{1}{4}$  circles make 1 circle? 2 circles?

How many  $\frac{1}{4}$  ovals make  $\frac{1}{2}$  an oval, 1 oval,  $1\frac{1}{2}$  ovals?

### Faces, edges and corners

An edge is a line that marks the boundary between one thing and another. The **edge** of a shape shows the outline of the shape. Encourage learners to use the word "edge" rather than "side". This is because the word 'side' is ambiguous. Learners could mistake the side for meaning the face of an object. Or if you tell them to 'stand to one side', this means something else again.

You can make copies of the different shapes on p358, p359 and p371.

- Give each group a set of cardboard shapes or pattern blocks. Make a set of flashcards with the names of each shape in the set. Read the names together. Pin the names on the board so learners can refer to them when they work. In their groups they should discuss the different shapes in their set, decide on their correct names and count and compare how many edges and corners they have.

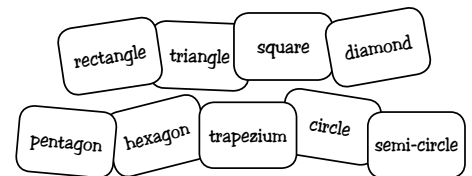

Notice that we introduce some shape names like "pentagon", "trapezium" and "hexagon" that may not be familiar to your Grade 3 learners. There is no harm done if you introduce a few extra shape names for them to learn. It is after all, far easier to refer to a hexagon, than to say, "a closed shape with six, straight edges" each time you want to talk about it! Of course we also want them to know what the properties of the shape are.

Learners must also know that we call:

- the flat surface of a 3-D object its face.
- the point where two lines meet, the corner (vertex).

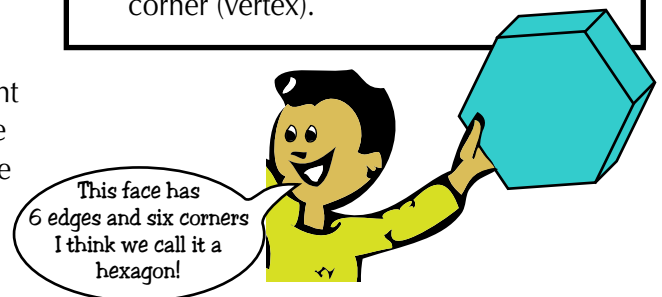

### Feely Bags









- Put a collection of different geometric cardboard shapes or pattern blocks into a bag. Learners take turns feeling for a shape.
- Without revealing the shape, they must then describe to the other learners in as much detail as possible how many faces, edges and corners it has. The other learners guess the name of the shape.



## Grade 3: Space and shape (geometry)

### The properties of 2-D shapes

Design a worksheet to help learners summarise their findings from the previous activity. Show them how to read the table first. Do one or two examples together. Where necessary, help learners fill in the names of unfamiliar shapes.

								
Shape								
Number of edges								
Number of corners								

### Four-sided shapes

Help learners to distinguish between rectangles, squares and other kinds of 4-sided shapes (quadrilaterals). Read the questions together.

Remember to emphasise the point that we've made before - that squares are also rectangles, but special kinds of rectangles, with four edges or sides the same length.

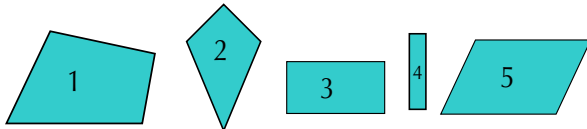

Talk about how these shapes are the same. Talk about how they are different.

Which shapes are rectangles? \_\_\_\_\_

Is shape 2 a rectangle? Why? Why not? \_\_\_\_\_

Finish this sentence: A rectangle is a shape that has \_\_\_\_\_.



Which shapes are 'ordinary rectangles'? \_\_\_\_\_

Which shapes are squares or 'special kinds of rectangles'? \_\_\_\_\_

Finish these sentences:

We call shape 2 a \_\_\_\_\_ because \_\_\_\_\_.

We call shape 4 a \_\_\_\_\_ because \_\_\_\_\_.

### Imagining straw shapes

- Ask learners to imagine that they have straws of the same length to build rectangles, squares and triangles. They must think about how many straws they will need to make:
  - the smallest possible square...the next biggest size square;
  - the smallest possible rectangle...the next biggest size rectangle;
  - the smallest sized triangle with edges of equal lengths;
  - a shape that is neither a square nor a rectangle, but still has 4 sides.
- Next let them describe the shapes they imagined. Then give each group a pile of straws to build the shapes. Let them check if the shapes they 'imagined' are the same as the ones they built.

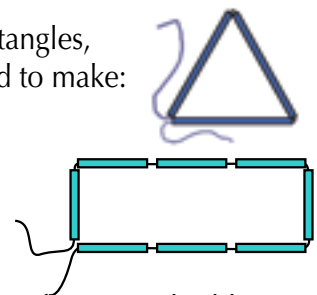

### Investigating triangles

You will need a set of different equilateral, isosceles and right-angled triangles for each group of learners. (See Resources)

You can add triangles from the Tangram puzzle as well (See Resource, p374). When you make copies, stick to one colour. This will help learners to focus on more important attributes of the shapes as they sort them.

Learners should sort the triangles into different groups and then explain how they did this.

End the activity with a whole class discussion to review the properties of the three kinds of triangles - equilateral, isosceles and right-angled triangles. Learners do not need to know these names, but should rather be able to describe their differences and similarities using their own informal language (see below).

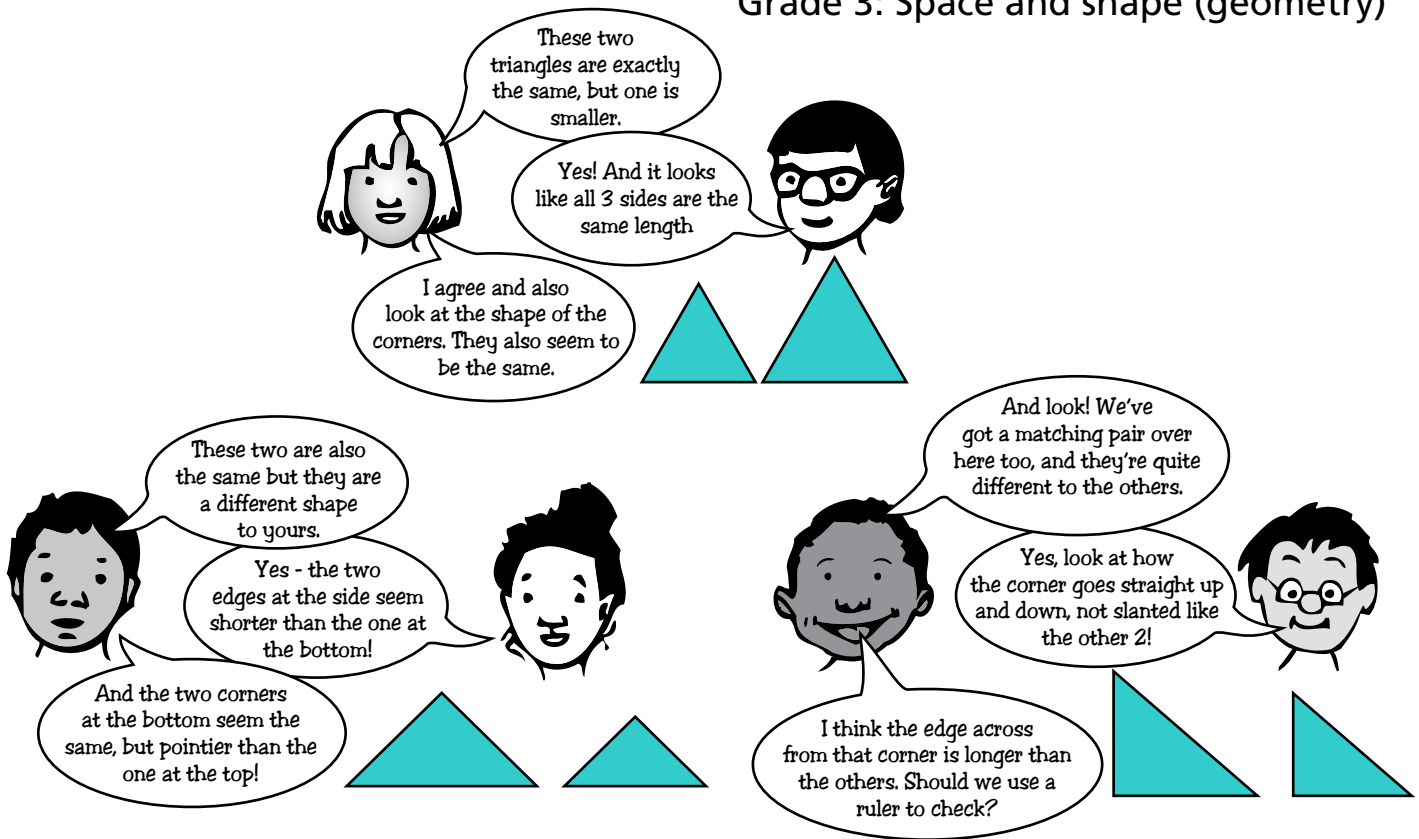

### Using geoboards

- Repeat some of the geoboard activities suggested for Grade 2 learners.
- Follow-up by giving learners instructions to make different kinds of squares, rectangles and triangles. For example:
  - Make as many different-shaped triangles as you can.
  - Make a triangle with its sharpest point (apex) at the top and then make the same triangle with its point facing left, down or right.

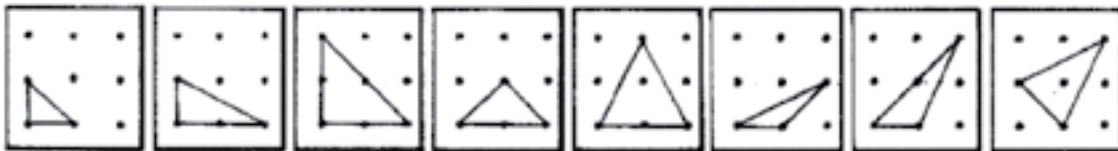

- Make a big rectangle. Divide the rectangle into two rectangles.
- Make the biggest sized square that will fit on the board. Divide the square into 2, then 4 triangles.
- Make as many different kinds of quadrilaterals as you can (four-sided polygons). Give each shape a name. Here they may use the correct mathematical names or make up their own names according to the 'forms' of the shapes they make.

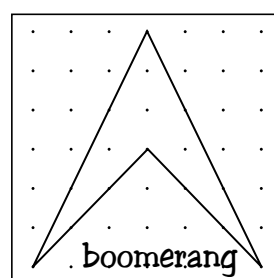
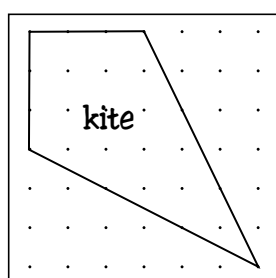
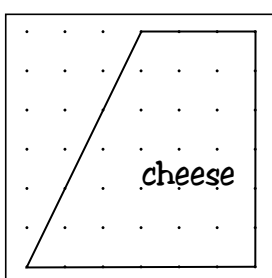
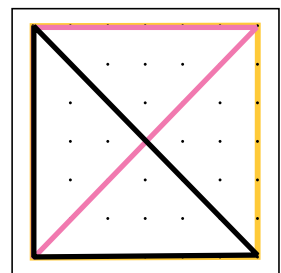
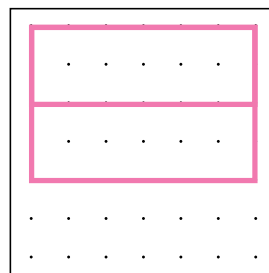



## Grade 3: Space and shape (geometry)

### Drawing 2-D shapes on dotted paper

Give each learner a sheet of dotted paper to practise drawing some of the 2-D shapes they have investigated so far. They first imagine their shape and then mark out the dots for the corners (where the edges start and end). They can then join the dots to form the edges. They can use their rulers to help them draw straight lines.

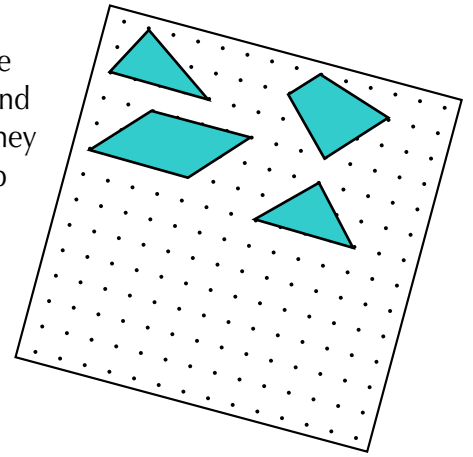

### Shading rectangles and squares on grid paper

Give each learner a sheet or two of 2 cm x 2 cm grid paper.

You will find a sheet in the Resource Section. (See Resource, p360).

#### Rectangles

On the grid, draw the smallest possible rectangle that is not square.

They can do this in two ways:

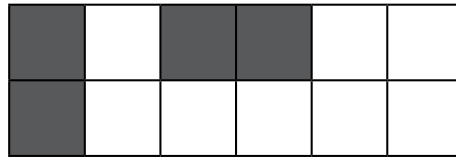

Find as many ways as you can to draw a rectangle that covers 12 blocks.

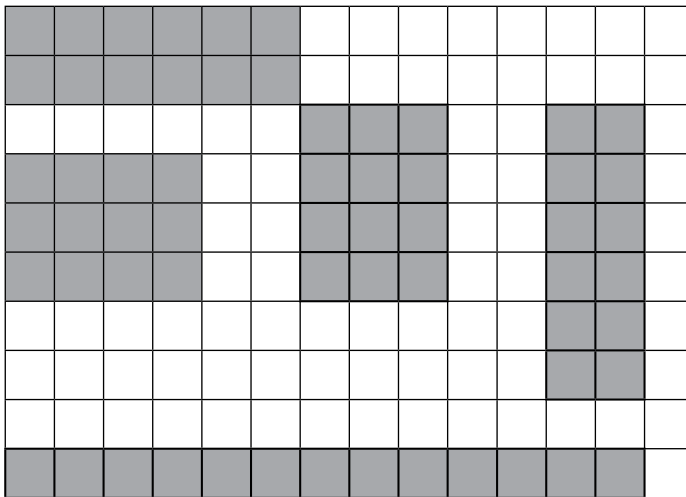

They can then do the same investigation with 24 or 36 blocks.

This activity links to both multiplication (factors) and area. To work out the possible ways to draw the rectangle, learners must think of the multiples of 12 (what x what = 12?). By checking that each rectangle covers 12 blocks, they are discovering something important about area - that the amount of space covered by a shape can be the same, even if the dimensions (length and breadth) of the shape are different. They are also discovering that shapes that look different can have the same area.

#### Squares on grid paper

Shade one square on the grid.

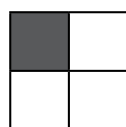

This is the smallest possible square using whole grid squares.

Now shade the next 3 sizes of squares.  
Write how many squares you cover each time.

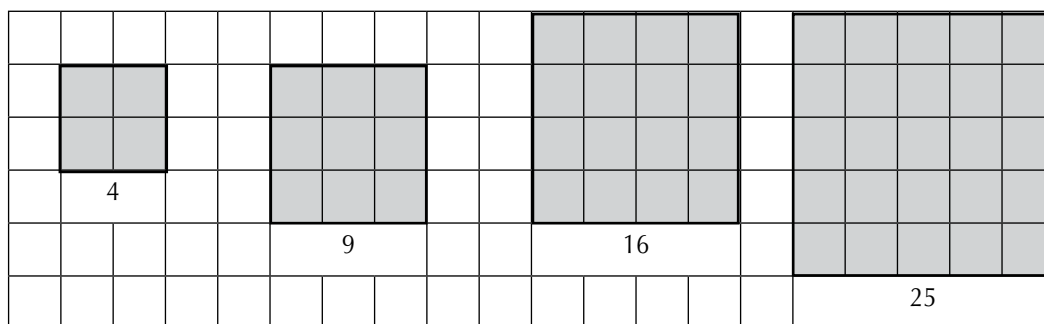

Learners can go on to map out even bigger squares on another sheet of grid paper. In a follow-up patterns activity learners can look for number patterns to help them work out how many more squares they need to shade for each successive square.

- If they count rows they will see that the rows increase by 1 each time.
- If they count how many squares to add on each time, they find that they must add 3, then 5, then 7 etc.

### Building 2-D shapes with geostrips

You will need geostrips and split pins.

- Learners can build any kind of polygon using geostrips and split pins. Geostrips come in different lengths so they can use them to build shapes with edges that have both equal and unequal lengths. Ask learners to build shapes of different sizes, starting with triangles, rectangles and squares. They can then try other shapes like pentagons and hexagons.

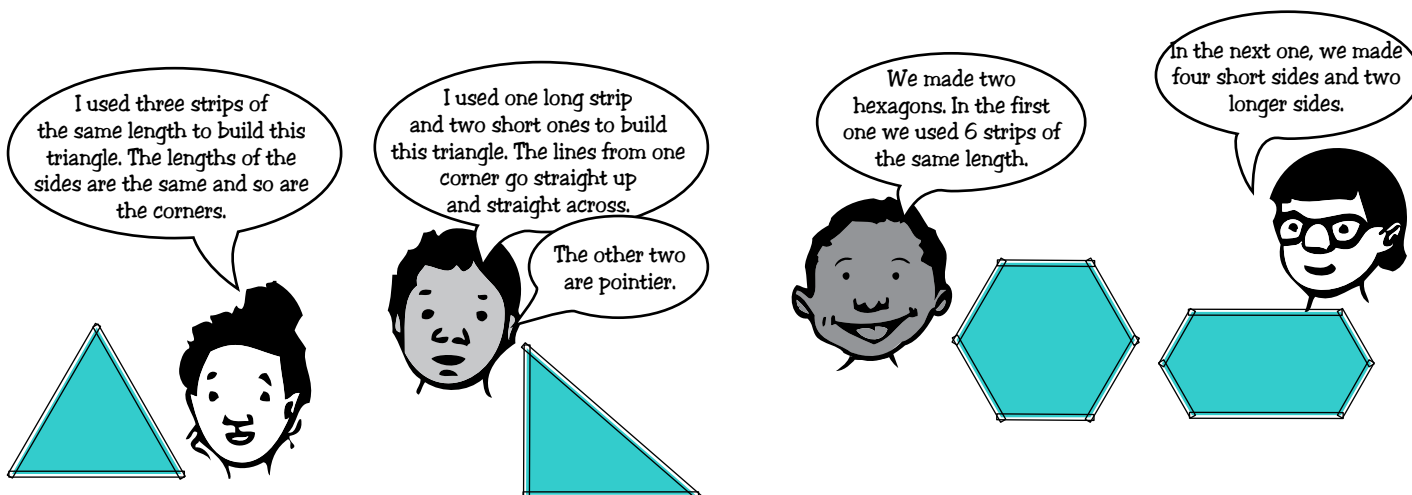

### Investigating 3-D objects

#### Games with 3-D objects

##### Pass a shape

- Use the activity to consolidate learners' understanding of the properties of 3-D objects that they learned about in previous grades. They can work in small groups. Give each group one 3-D object, for example a cylinder, a prism, a sphere or a hemisphere to investigate. They should pass the object around the group. As they do so, each learner must say something new about the object.

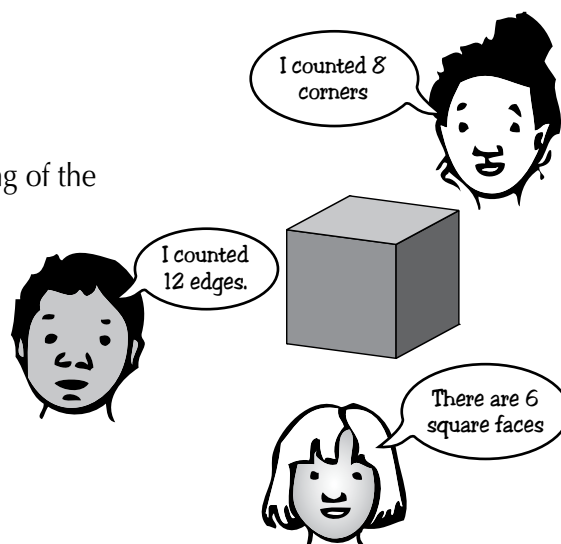

## Grade 3: Space and shape (geometry)

- Once they've described the object, hand them another object to describe in the same way. End the activity with a whole class discussion where learners give feedback and take turns to describe the properties of the different objects they explored, giving as much detail as possible.

Collect and let learners collect examples of the various objects. Also let learners construct them using the nets on p351 to p355.

### Memory Game

- Play a memory game to further consolidate learners' understanding of the similarities and differences between different 3-D objects. On a board or tray, arrange examples of 3-D objects in two or three rows. Include examples of a cube, a cuboid (rectangular prism), a triangular prism, a cylinder and a sphere.
- Hold up one of the objects and ask learners to say as much as they can about it. They can simply name the object and call it a cylinder, but they should also describe the properties of a cylinder.
- Now explain that they are going to play a memory game with more 3-D objects. Walk around the class with the objects arranged on the tray. Ask learners to try to remember the kinds of objects on the tray and their position on the tray. Make sure that all learners have the chance to look closely at the arrangement.
- Go back to your desk and cover the tray with a cloth. Remove one object, without letting learners seeing which it is. Take off the cloth. Walk around the class once more with the tray. Learners must work out what the missing object is. They must not shout out but should write down what they think it is.
- Let some learners tell the rest of the class as much as they can about the missing shape. For example, if it was curved or straight, whether it could roll or slide, the shape and number of faces it had, which faces were the same and if they can, name it correctly.
- Once they've done this, produce the object and place it back in the same position on the tray. Play the game until learners have had a chance to identify, describe and name each of the shapes on the tray.
- If you have a large class, you can play the game in turns with groups of learners instead.

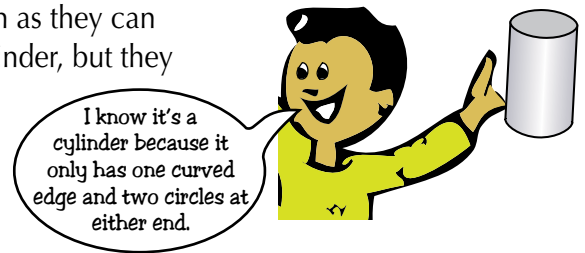
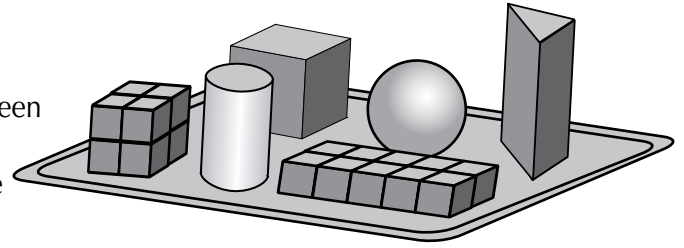

### Free sorting

Work in groups. Give each table a collection of the same, familiar 3-D objects to sort, using their own criteria. At this stage, do not include cones or pyramids.

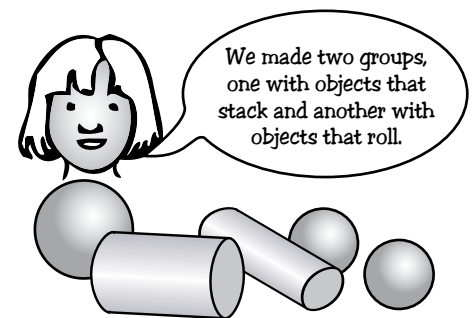
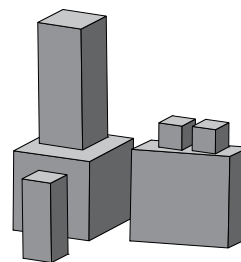

### Sorting according to given criteria

- Give each group of learners a set of blocks or 3-D objects or models to sort, according to criteria you give them. For example:
  - Sort the objects according to the number of faces they have.
  - Now re-sort them, according to the shape of their faces.
  - Count how many edges each object has and re-sort the objects according to how many edges they have.

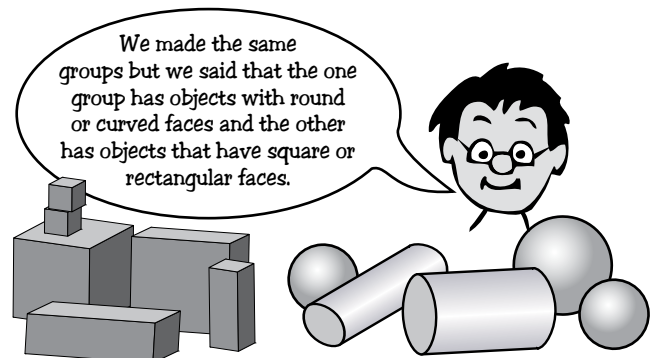

## Grade 3: Space and shape (geometry)

- Make time for learners to talk about their groups of objects and to think about how objects in the same group are both similar and different.

### Prisms

In Mathematics boxes that have two end 'faces', or bases, that are the same shape are called prisms. These two identical shapes must be joined by shapes that have straight edges. I've got a group of shapes here on my table. Some are prisms and some are not.

The one has triangles at the end and the other has squares at the end, but I think they're the same kind of objects, because in both blocks the sides are rectangles!

I'm going to give you turns to come up to the front and choose a block from this group of objects that you think is a prism. You must tell the rest of the class why you think so!

Yes and their end faces are the same! I think we call them prisms.

### Counting the corners and faces of different prisms

Make up a worksheet with different prisms. Learners should count how many faces each figure has, what shapes these are and count the number of edges and corners. Let learners, who cannot yet visualise the numbers of edges and faces from the drawings, use concrete objects to check their ideas.

	Shape 1	Shape 2	Shape 3	Shape 4	Shape 5	Shape 6
Number of faces						
Shape(s) of faces						
Number of edges						
Number of corners						

### Tracing faces

Let learners trace around the faces of different 3-D objects to make 'footprints' of the different faces. They can also dip the objects into paint to do this. Before they start, they should predict what they think the shape of each footprint will be.

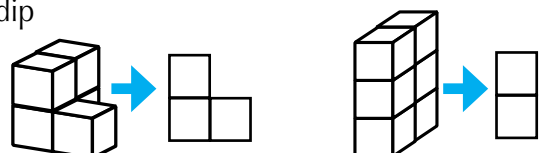

## Grade 3: Space and shape (geometry)

### Introducing cones

- Collect different cone-shaped objects and make models of cones using the net in the Resource Section ([See Resources, p353](#)). Give each group two or three examples for them to study. They should think about:
  - how many faces and edges there are;
  - whether there are corners or not;
  - how the different examples are both the same and different.
- Make time for a class discussion for learners to share their findings. Help them to come up with a definition of a cone.

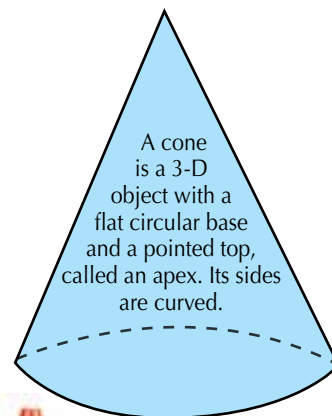

### Creating cones

- Give each learner a page of A4 paper. Show them how to fold and tear or cut the page to form a square.

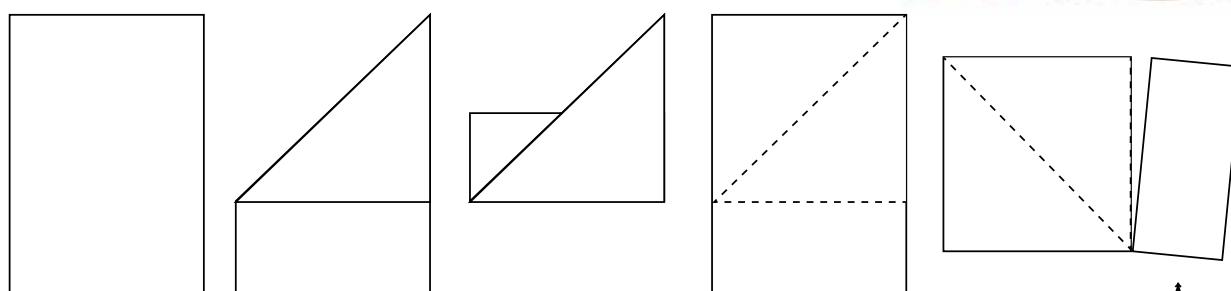

- Now show them how we can fold a square into a cone-like shape. Let them do the same. Next talk about how this form, is 'cone-like' in shape, but it is not a true cone, because the bottom edge does not form one curved, circular edge.

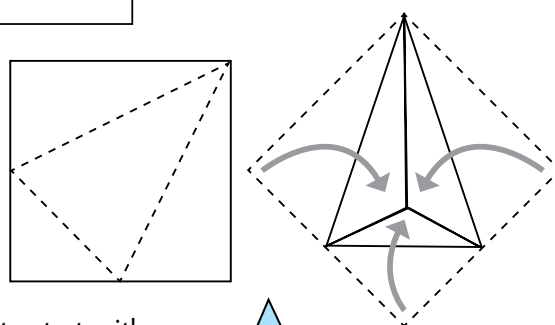

- Explain how a better way to make a perfectly formed cone is to start with a circle. Give each learner a copy of the net for the cone that you will find in the Resource Section ([See Resources](#)) and a pair of scissors. Show them how to start by cutting out the circle outline and then cutting along the fold line to make the cone.

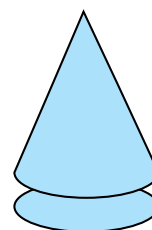

- Once they've done this they can add a face to close the cone, by tracing a circle around the bottom edge of the cone on another piece of paper and then glueing it carefully along the bottom edge of the cone.

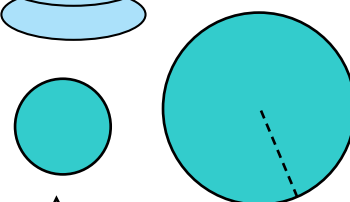

- Give learners different sized circular templates that they can use to trace circles to make more cones of different sizes. They can also work out ways to make the cones pointier or flatter, by changing the length of the cutting line, or by changing the overlap when you fold the cone.



- Talk about where we find cones in everyday objects. For example, ice cream cones, tops, cartons for holding food in, party or clown hats.





### Rolling objects

- Revise the differences between objects that slide and objects that roll. Use a cube and a ball or similar spherical-shaped objects. By now learners should all be able to explain that objects like cubes with straight sides, edges and corners can only slide, whereas a ball with a curved face can roll freely.
- Give learners the chance to investigate how different curved objects roll. Give each group a collection of 'rounded' objects, including spheres, cylinders, cones and egg-like shapes and ask them to investigate and compare their different rolling actions. They should discover that they can make:
  - a sphere roll in any direction;
  - a cylinder roll in a straight line;
  - a cone roll in a circular path;
  - a shape like an egg roll in a 'wobbly' sort of way.

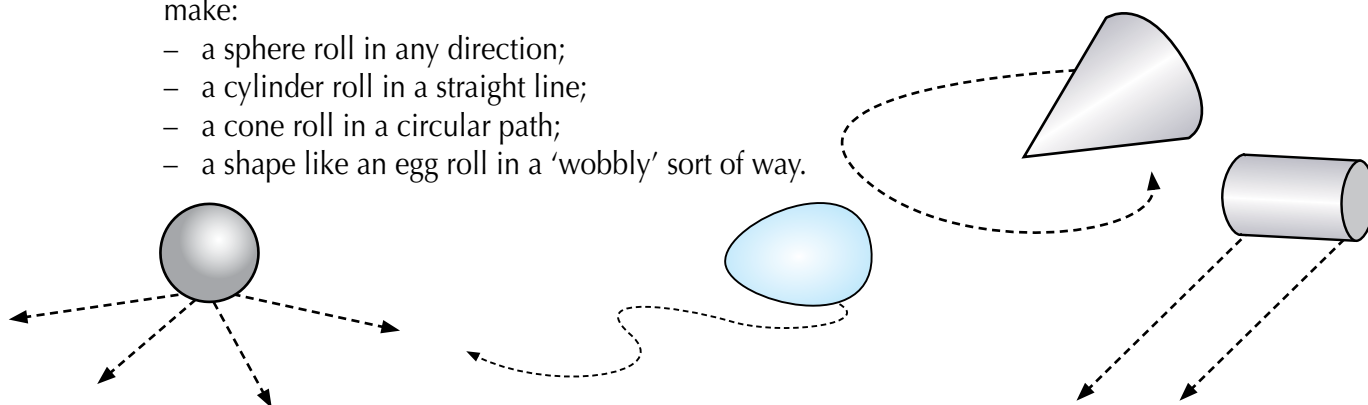

### Drawing and 'shaping' rolling forms

Once again give learners the chance to practise drawing these objects. They need not be 100% accurate representations, but should show some signs that they can distinguish their shape and also that they can find a way to show the third dimension. They may do this by shading the drawings or by adding in lines to show that the objects have depth as compared to flat shapes that have only length and breadth.

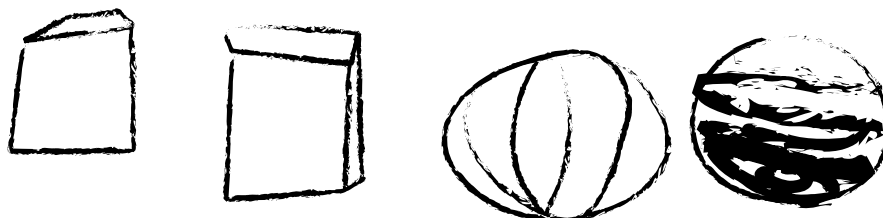

### Joining objects

Give each pair or group of learners the following pairs of objects of the same size:

- two cubes
- two cuboids
- two cylinders
- two cones

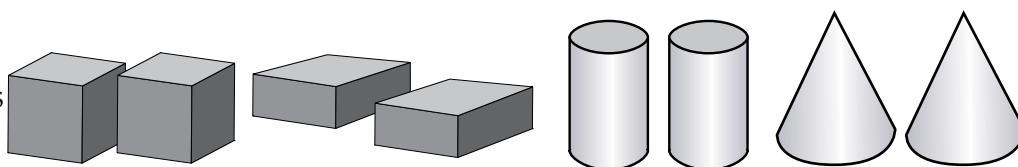

They should investigate what shape they get when they try to join the pairs together along one of their faces and discover that:

- two cubes joined together do not make a cube since all the faces of the new shape are no longer squares;
- two identical cuboids fit together to make another cuboid;
- two identical cylinders fit together to make another cylinder;
- two cones fit together to make a composite shape which is not a cone.

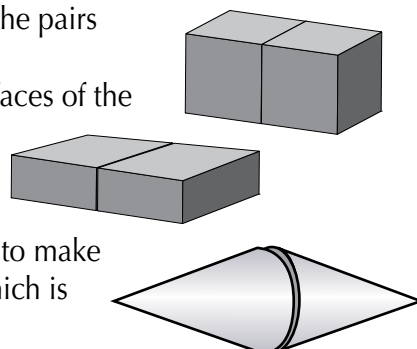



## Grade 3: Space and shape (geometry)

### Modelling and drawing of 3-D objects

- Give learners some plasticine, play dough or any other type of modelling clay to build models of all the different solids that they have learned about so far. By physically moulding a rectangular prism or a cube or a cone, by patting a ball of clay into shape, they will come to see the differences between them far better than if they only look at pictures or ready-made models of the objects.

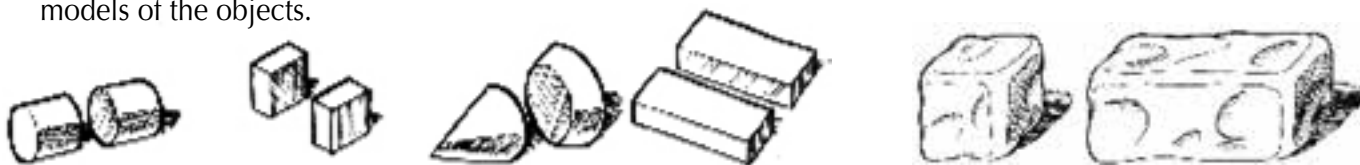

- To mould cones into shape, they can start off with a cylindrical shape and then roll it into a point between the outer edges of their hands.
- Follow up by giving learners more practice drawing these objects. The more practice they get drawing these objects, while at the same time feeling them, and viewing them from different positions, the greater likeness there will be between their drawings and the objects themselves. This process is far more useful than giving them 'ready-made tricks' on how to draw cubes.



### Cross-sections

- Working with modelling clay or plasticine, learners can also start to do informal investigations into cross-sections of different objects, by seeing what happens when they cut through them at different points along their length or breadth. This will help them find out more about the similarities and differences between different groups and sub-groups of 3-D objects. Encourage them to first predict what will happen before they cut through the object and then check to see if their predictions were correct.

#### Cutting through prisms

- In Grade 2 learners found out that the two end faces of regular shaped boxes (prisms) are always polygons (closed shapes with straight sides) of the same shape and size, and that their side faces are rectangles, (which could include squares).
- When learners cut through any prism, at any level, they will find that they get the same cross-section all the way along its length or breadth. This is a further defining property, or characteristic, of a prism.
- If they cut through the middle of this triangular prism, either long ways or across, they will be left with two equal prisms with flat rectangular faces of the same size.
- If they cut through at a point that is not the middle, they will still be left with two prisms, although these will be different in sizes.

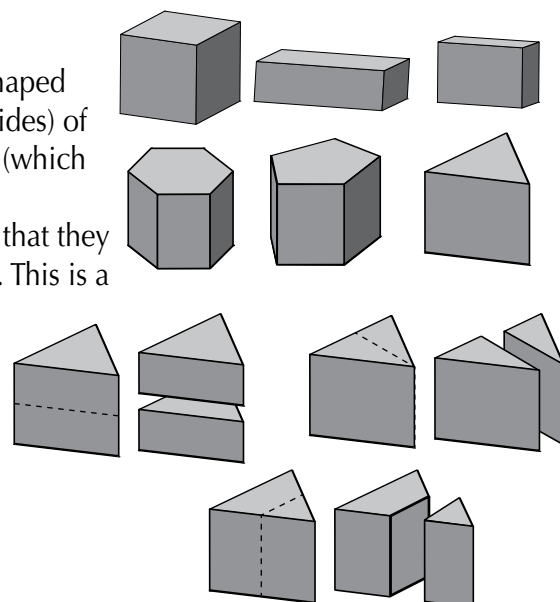

#### Cutting through cylinders

Learners will discover the same about cylinders. When cut at any point along their length (or breadth), a cylinder has the same shaped cross-section.

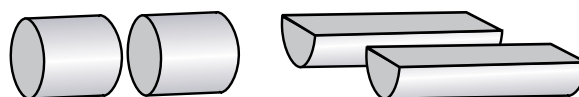

## Cutting through cones

In the case of a cone, a horizontal cut will produce two unequal parts. The upper section will remain a cone, but the lower section will look like a flattened cylinder with a widened base. Both parts will have circular end faces.

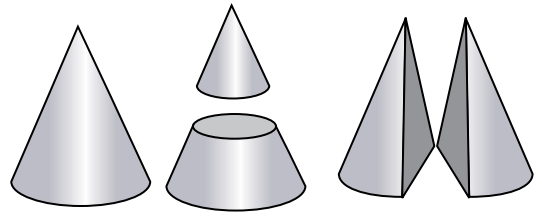

## Cubes and cuboids

(square and rectangular prisms)

A **cube** is a 3-D prism with six **square** faces. A **cuboid** is a **rectangular** prism with six faces.

- Collect some examples of cubes and cuboids for each group of learners. These could be blocks or cartons.
- Make sure each group has one of each kind – cubes with square faces, cuboids with square and rectangular faces and cuboids with only rectangular faces.

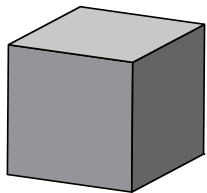

**Cube** with six square faces

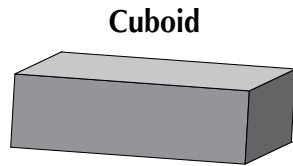

**Cuboid**

Two end faces are squares. The rest are rectangles.

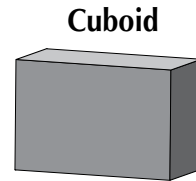

**Cuboid**

All six faces are rectangles.

- Learners must examine each box closely and then sort them, according to the three categories above. They should then explain what is the same and what is different about the groups.
- Let learners try to draw the three types of objects to help develop their visual representation skills. Remember accuracy is not important here, but rather that learners begin to find their own ways to show a third dimension in their drawings. They also need to show differences between prisms according to the shapes of their faces.

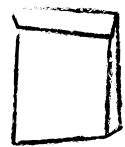

## Building bigger prisms with small cubes

Give each learner or pair of learners four small cubes. They must join them in different ways to see what new shapes they get. The faces must join along one side.

These are the possible arrangements they can make:

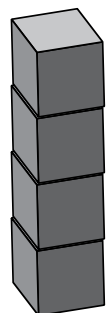
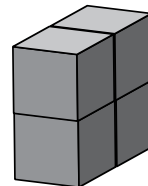
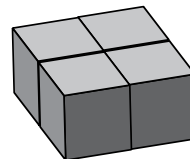
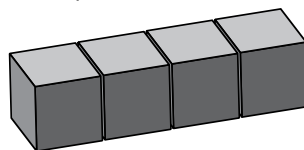

- Some learners may think they have made more cubes, because they started with cubed blocks. Remind them that for a prism to be a cube, all of its six faces must be square. So the only possible models they can make from four single cubes joined together, with faces touching, are rectangular prisms (or cuboids). In two of the possible designs, two of the four faces will be squares.
- Using more cubes, challenge learners to now work out how many small cubes they will need to make the series of next biggest sized cubes. They should discover that the next biggest cube has to be  $2 \times 2 \times 2$  and will use 8 small cubes. Thereafter the next possible cube will be  $3 \times 3 \times 3$  and will need 27 small cubes.

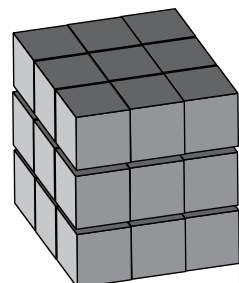
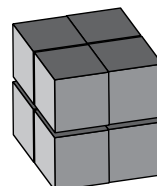

## Grade 3: Space and shape (geometry)

- Let them then make rectangular cuboids using the same number of blocks they used for the cubes. Compare these with the cubes they made to see that, although they are different in form, they use the same number of blocks.

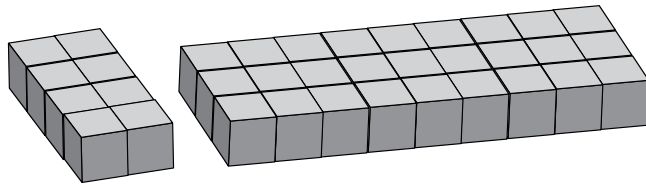

### Introducing the pyramid

By Grade 3 learners need to know about pyramids as well as prisms. At first glance, learners may confuse triangular prisms and pyramids because both kinds of object have pointy ends and triangular faces. But on closer examination, they will come to see that unlike prisms, pyramids have only one base. The base may be any polygon (straight-edged shape) such as a square, a rectangle, a triangle, a pentagon, a hexagon. The side faces of pyramids are triangles and they all meet at a single point. The number of sides of the base shape determines how many triangular side faces the pyramid has.

Triangular prism

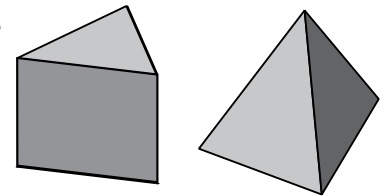

Pyramid

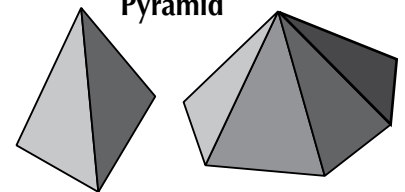

### Comparing prisms and pyramids

Copy the nets from the Resource Section (See Resources, p351 and p352) to make models of both a triangular prism and a triangular pyramid for each group of learners. The groups should discuss and compare them. Once they've done this, make time for a whole class discussion to review their findings.



### Other kinds of pyramids

- Once learners have got this far, you can introduce them to other examples of pyramids with different shaped bases and more triangular faces. Make models of these from nets you will find in the Resource Section. Start with a square-based pyramid. Learners should discover that it has four triangular faces and that the base of the pyramid is a square. Help them to see that in any pyramid there is a relationship between the numbers of edges and the number of triangular faces that the base has.
- Show learners pictures of the Egyptian pyramids or Mayan pyramids as examples of how ancient civilizations built pyramids, usually as tombs for the dead.



## Grade 3: Space and shape (geometry)

- Next introduce a rectangular pyramid that has two smaller triangles on the end and two bigger triangles on the sides (See Resources, p387). Help learners to see a correspondence between the shape of the base which is a rectangle and the size of the opposite pairs of triangular faces. The triangles that join the shorter edge of the rectangle will be shorter at the base than the ones that join the longer edge of the rectangle.
- Next introduce models of square, pentagonal and hexagonal pyramids (See Resources, p354, p388 and p389). Ask learners to look at the base shape and count how many edges it has and then see if the pyramid has a corresponding number of triangles. This will help them to generalise a rule for pyramids - that for any pyramid, the number of triangular faces it has depends on the number of edges or sides that the base shape has.

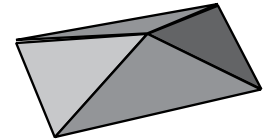

aerial, or bird's eye view

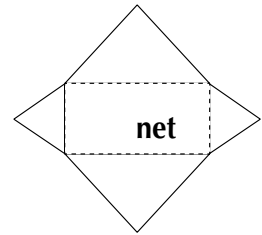

4 triangles

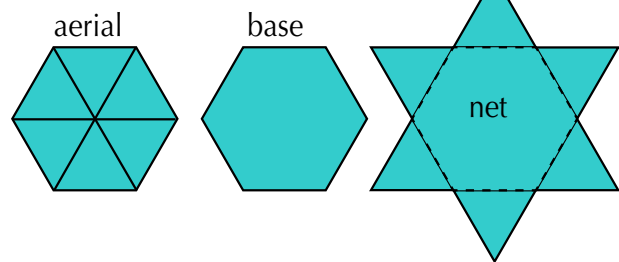
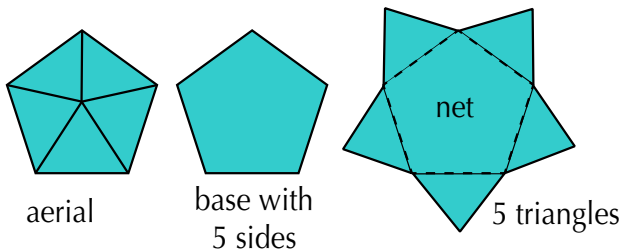

### Sorting 3-D objects

Now that learners have worked with prisms, cones, cylinders and pyramids, you can give them another sorting activity to help consolidate their understanding of the differences and likenesses between all of these figures. Give each group a wide selection of objects to sort. Use models made from the nets provided in the Resource Section as well as blocks, and objects like boxes, tins, dice, cones, party hats and balls.



Tell learners that they must sort the objects into groups according to their mathematical properties, write labels to name each group and then explain to the rest of the class how they decided on their groups.

To help them, prepare a set of flashcards with the names of the different kinds of objects. Put these on the board for learners to refer to and copy when making their labels.

As learners work, walk around the class and talk to the different groups. Ask them questions about how they sorted the objects and which attributes, (like colour or size or shape of faces) were *not* important when they did their

So in this group you have 3 objects you call prisms, but they all have different kinds of shapes for their faces. Some are bigger than others. Are you sure they are all prisms? How do you know?

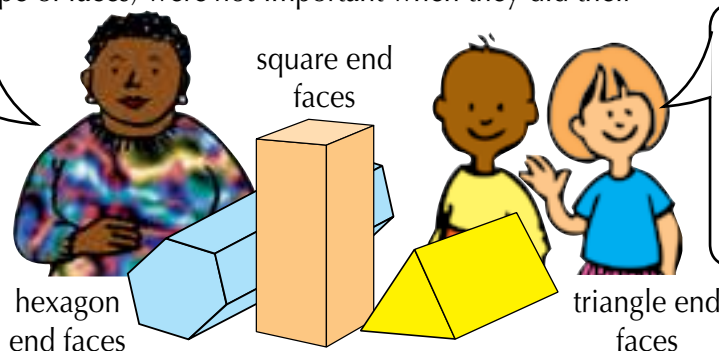

We know they are because they have rectangles on the side faces. And also the two end faces are always the same. In this one they are squares and in this one they are hexagons. It does not really matter how big or small they are either!



## Grade 3: Space and shape (geometry)

### Guess which object

Working with the same collection of objects. Play this game. Put a collection of 3-D objects on your table. Choose one without telling the learners which it is and describe it in as much detail as possible. They must all listen carefully and then decide which object you are talking about. Invite a learner who thinks he or she knows, to come up to the table and hold up the object they think it is. If correct, that learner then gets a turn to choose an object to describe to the rest of the class. The game continues in this way with learners taking turns to describe and name the different objects.

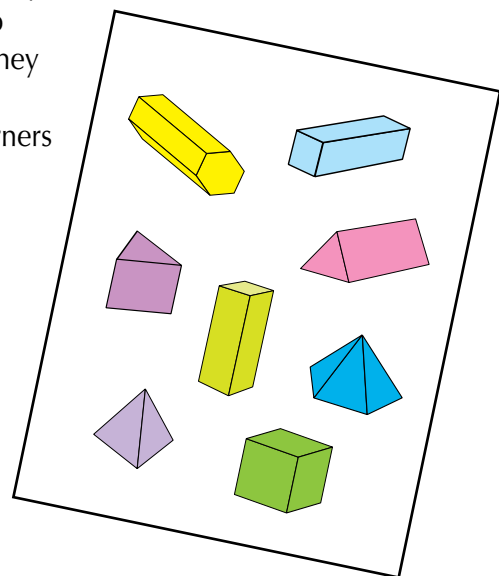

### Interpreting drawings of prisms and cylinders

Make up a worksheet that has pictures of different kinds of prisms and pyramids. Learners work in pairs or small groups. They take turns to choose one of the figures to describe to their partners. They in turn must guess which one it is.

### Investigating nets

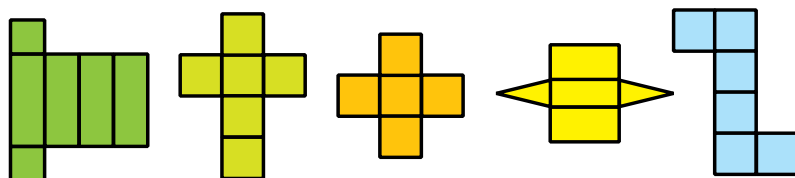

- Collect some cartons and boxes of different shapes and sizes. Give each pair of learners one box to work with. They should spend time looking at it from all sides, talk about the shapes of the faces, how many there are, which are the same, which are different and what the box would look like if they were to cut it open and spread it out flat. How will the faces fit together? Which faces will join? In what positions will the different faces be?
- They should then draw a sketch of what they imagine it to look like, open up the box and flatten it out to form a net and compare the design of the actual net with their sketches of the nets. Let them also trace around the net and compare their tracing with their original sketch. They can then put the box together again by folding along the edges and fold lines.

### Tracing nets

- Explain that a net is the name that we give to a 2-D flat design that we can fold into a 3-D shape. It is like a jacket for a 3-D object, like a cover for a book or a wrapping for a parcel.
- Use the net for a cube in the Resource Section ([See Resources, p355](#)) to demonstrate how we can fold it into a cube to cover another cube of the same size. Talk about examples of when it is useful to have nets of objects handy. For example, when you want to transport big boxes for packing your household goods, or at a cake or food shop where the nets are kept flat until the cakes are bought and packaged. Sometime when you buy party hats, they come in a flat packet. You then have to fold them or 'pop' them out as you wear them. So nets take up less space than the objects they fold into!
- Let learners work in small groups. Give each group a model of a cube, a rectangular prism, a triangular prism, and a square-based pyramid. You can find nets for these in the Resource Section ([See Resources](#)).



## Grade 3: Space and shape (geometry)

- In pairs, one learner holds the object on a page, while the other traces around its faces. Faces must be joined to make a net. After tracing around all the faces, they check to see if they have drawn all the faces and if they're joined to one another in the correct way. Give them time to re-draw these if they need to.
- They then take another object and trace around it using a different coloured pencil.
- Once they have traced around all of the objects in the same way, ask learners to think about the following;
  - Does each net have the same number of faces as the object it matches?
  - Which nets are easier to trace than others? Why?
  - Are the nets drawn correctly? Do they fold up to make the same shape as the object? Learners can cut out the nets to check if they do.
- Learners can see if they can make covers for the models that they traced around.

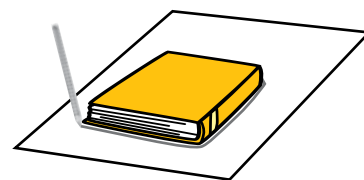

Match each net with the 3-D object it folds into. Write the name for each object.

### Matching nets

Once learners have had practice working with nets in this way, prepare a worksheet for them where they link pictures of different nets with the object they fold into. They must also write the name of each object. Have flashcards with these names on the board for them to refer to.

You can make copies of the worksheet on p377.

Without looking back at the previous activity, give learners this follow-up worksheet. They must draw matching nets for each 3-D object. This builds on the previous investigations. With practice, they will start to draw these nets with greater accuracy and detail. But once again, do not insist on perfection! Rather focus on whether learners can draw the right shaped faces, and if they know how these fit together to fold into the object.

Draw the net for each of these 3-D figures.

### Drawing nets for cubes and cuboids

- Give each learner a sheet of 2 cm x 2 cm square grid paper. They are now going to explore how to draw nets for cubes and cuboids on grid paper. They will need to count how many blocks they need for each drawing and think about how to fit the drawings onto the sheet of grid paper. They can start with cubes and cuboids that have an open top. Later they can work on cubes with closed tops and add faces to their basic designs.



### Grade 3: Space and shape (geometry)

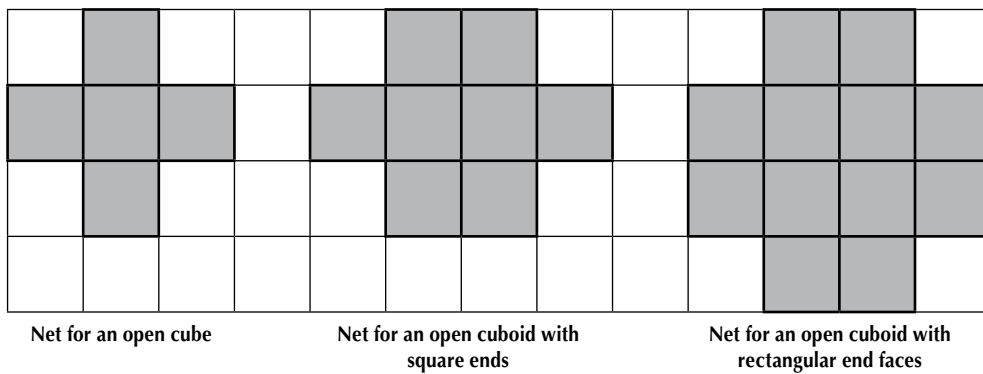

- Make time for learners to share and discuss their designs and to then re-draw these if they are not correct. There is more than one way to do these, but these are the most simple and most likely examples.

## Pentominoes

A **pentomino** is a flat shape made up of 5 square blocks joined together, edge to edge. At least one edge of a block must join with the edge of another block.

- Show learners examples of a few different arrangements of pentominoes, drawn on 2 cm x 2 cm grid paper.

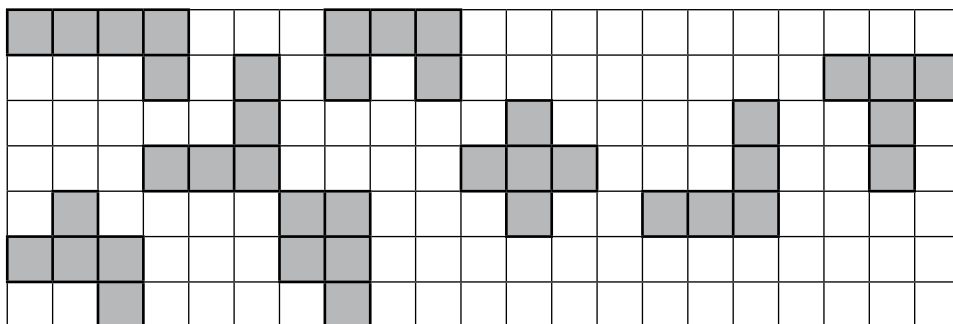

- Give them enough time to look closely at each design. Next ask them to predict which of them will fold into open cubes and which won't. Let them then cut out the designs and test their predictions.

## Building houses

- Use the nets in the Resource Section ([See Resources](#)) to make models of these houses. If you can find pictures or photographs of houses like these, use them to make a classroom poster so learners can see real examples of both traditional and modern forms of housing.

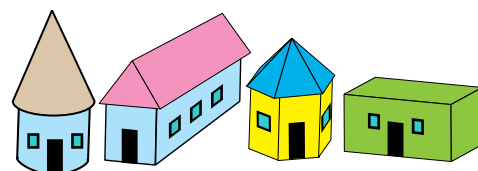

- Discuss the designs of each model house together. See if learners can name the different 3-D objects that make up the roofs and the walls.
- Now ask them to think about what the design for the net for each part of the different houses will look like.

Start with one model at a time. Let learners walk around the model so that they can get a close-up look of the different views of the house.

Invite a volunteer to come up to the board and draw a rough sketch of how the net would look. The rest of the class can give feedback. If the drawing is incorrect, and the learner does not know how to fix it, let her ask for help from other learners. Repeat this process for all the nets.

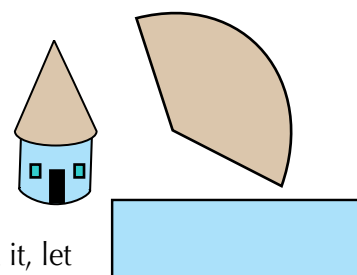

- Have enough copies of each of the nets for learners to work with in their groups. Explain to the class that you want each group to make at least two examples of each model house. When they have done this, they are going to build a model village by arranging the models on a large sheet of cardboard.

To begin, they should first sort the nets and find which ones go together for the roof and the base sections.

- Before folding the nets, they can colour in the parts and make wall patterns or tiling or thatching patterns on the roofs.

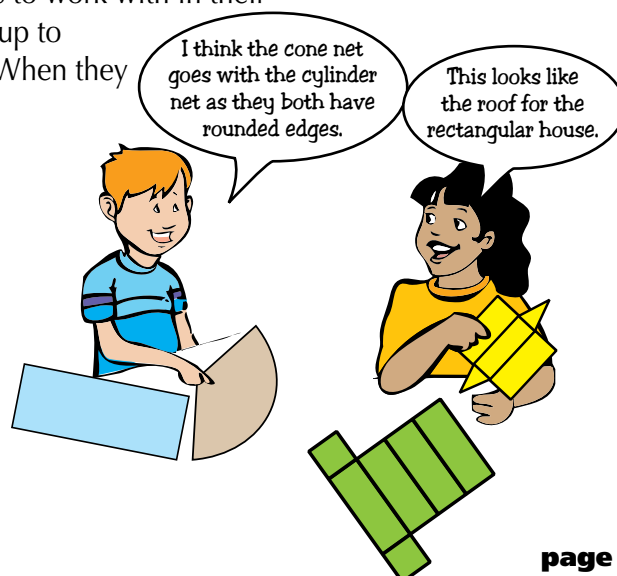

## Grade 3: Space and shape (geometry)

They can then cut the nets out and fold them to see how the parts fit together. They can mark spaces for the doors and windows and cut them out, before glueing the nets together.

- When they have made all the models, give out a large sheet of cardboard to each group. Together the group should discuss how they want to arrange their houses on the cardboard sheet to create a model village. They must create paths and roads in between the houses and give their village a name.



Hold a whole class discussion. Ask each group to elect two members to come to the front and talk about their village. They must describe each model and the shapes that make up the roofs and the walls in detail and talk briefly about the layout of the village. Once each group has given their presentations, clear space to display the models around the classroom. Learners will work with the models once more when they come to do maps.

### Constructing 2-D Shapes

#### Cut and fold

Give learners three to four paper templates of each of the shapes below.

**Note:** You can do the same activity using small plastic or cardboard shapes.

Learners must re-construct the template shapes by covering them with smaller shapes.

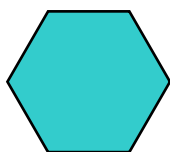

Fold and cut the hexagon to make  
3 diamonds (rhombuses),  
6 triangles,  
2 four-sided shapes,  
1 rectangle and  
2 triangles.

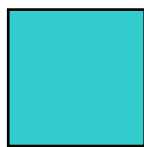

Fold and cut the squares to make  
2 rectangles,  
2 triangles,  
4 triangles,  
4 squares and  
16 squares.

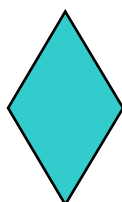

Fold and cut the diamond in two different ways to make 2 triangles.

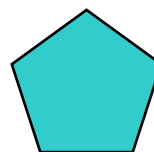

Fold and cut the pentagon to make 5 triangles.

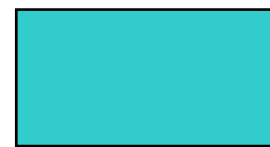

Fold and cut the rectangle to make  
2 rectangles,  
4 rectangles,  
2 squares,  
2 triangles and  
4 triangles.

### Tangrams

A **Tangram** is a Chinese shape puzzle. There are many versions. This one consists of seven pieces:

- a small square
- two large triangles
- a parallelogram
- two small triangles
- a medium-size triangle

#### Making shapes from other shapes

- Make a copy of the Tangram in the Resource Section (p374) for each learner. Let them cut out the shapes. Before they do this, ask them to first look at the different shapes to see how they fit together to form the outer square. Ask questions like:
  - Which shapes are triangles?
  - Is shape 5 a rectangle? Why do you say so?
  - Is shape 1 a rectangle? Why do you say so?
  - How could you turn shape 5 into 2 triangles?

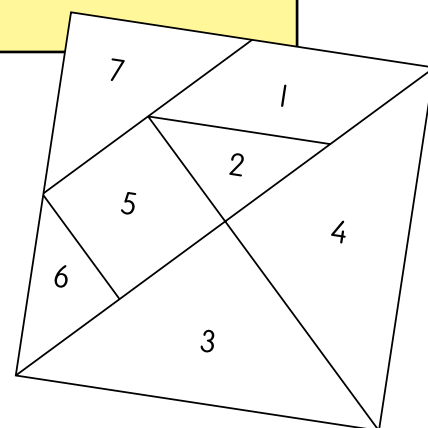

## Grade 3: Space and shape (geometry)

- They can then cut the shapes out carefully. Give them time to freely explore the shape pieces, find ways to fit them together to build new shapes and create patterns of their own.
- Once they have done this for some time, give them more guided instructions and questions to help consolidate what they have already learnt about some of the properties of triangles, rectangles and squares. For example:

- Use shapes 2 and 6 to make a square the same size as shape 5. How do you know that you made a square?
- Use shapes 2 and 6 to make a triangle the same size as shape 7. How do you know you made a triangle?
- Use shapes 2, 6 and 7 to make a square. How do you know the shape is a square?
- Use shapes 2, 5 and 6 to make a rectangle. How do you know it's a rectangle?
- Use shapes 2, 6 and 7 to make a triangle the same size as shape 3. Is there only one way?
- Now use shapes 1, 2 and 6 to make a rectangle. Is there more than one way?

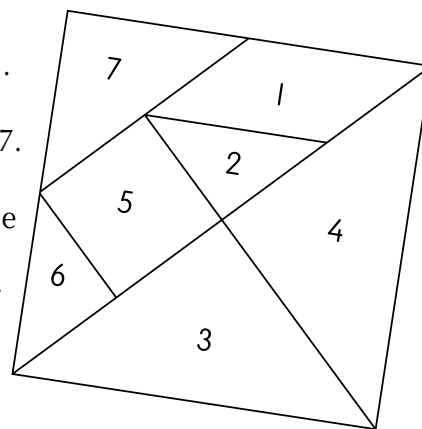

### Tangram pictures

#### Version 1

Use cut-outs of the Tangram pieces to make a variety of Tangram pictures like this. Make two copies for each picture, one without the lines drawn in and the other with the lines shown.. The cards with the lines drawn in are the solution cards.

Each learner or pair of learners gets a card of a picture with no lines. They must try to copy the picture using all 7 Tangram pieces. Give them enough time to try and work these out on their own. There may be more than one solution. If learners get stuck they can help one another. If nobody in the group can find the solution, give out the corresponding solution card and let them build the picture, first on top of the card, then next to it and finally from memory.

#### Version 2

Give one child in each pair the card with the lines drawn in and ask them to give step by step instructions to their partners without showing them the picture. The partner must try to make up the picture. They then swap roles and the other learner gets a chance to describe a picture for their partner to make.

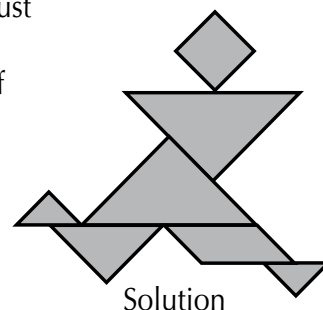
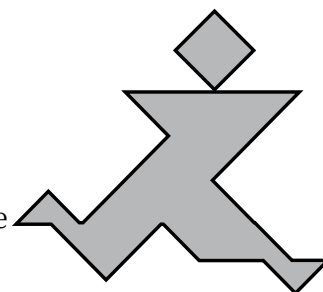

Solution

### Mind-bending shapes

Learners need to have short sticks of the same length or used matchsticks.

- Give learners a copy of this design or draw it on the board, showing them how it can be made from matchsticks. Ask them to:
  - Build the figure using their sticks.
  - Say how many triangles they can count.
  - Take away 6 matchsticks so they have only 1 triangle left.
  - Build the figure again. Take 2 matchsticks away so they are left with 3 triangles.
- You can then challenge them further with this example:
  - Use matchsticks to build this triangular design.
  - How many matchsticks do you use?
  - How many triangles have you got?
  - Take away 7 matchsticks so you are left with 3 triangles.

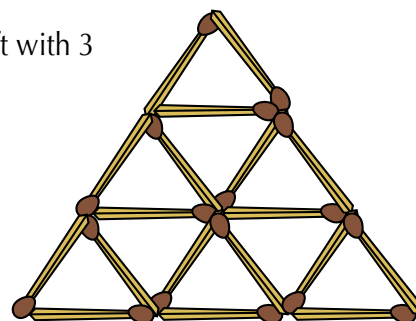
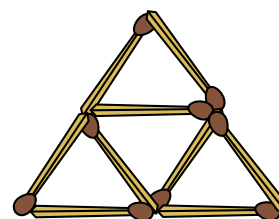

## Grade 3: Space and shape (geometry)

- Take away 9 matchsticks so you are left with 3 triangles.
- Take away 11 matchsticks so you are left with 3 triangles.

### Building polyhedra

A **polyhedron** is a 3-D shape with many faces. If each face is exactly the same we call them regular polyhedra. There are only five regular polyhedra which are also known as Platonic Solids.

Learners can begin by making the first 2 polyhedra with toothpicks and prestik. They will notice that the cube is wobbly while the tetrahedron is more rigid and does not change shape when they lift it. Use this as an opportunity to talk about why we use triangles as design features in buildings. For example, in the trusses for roofs.

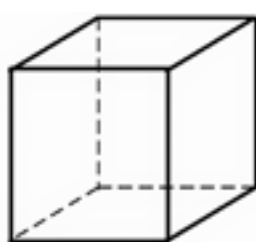

hexahedron/ cube  
6 faces

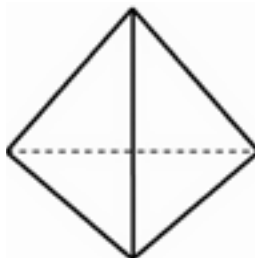

tetrahedron  
4 faces

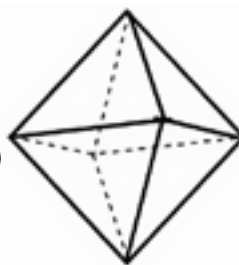

octahedron  
8 faces

### Building polyhedra with straws and string

In order to guide your learners on how to make these models, it is important that you learn how to make them yourselves. Read through the instructions for each example. Make one copy of each model for each group of learners. When you are sure how to make them, and can give your learners the same step by step instructions, plan to make the models together in class. Give out straws, string and scissors to each group of learners. Two learners can work together to make one model.

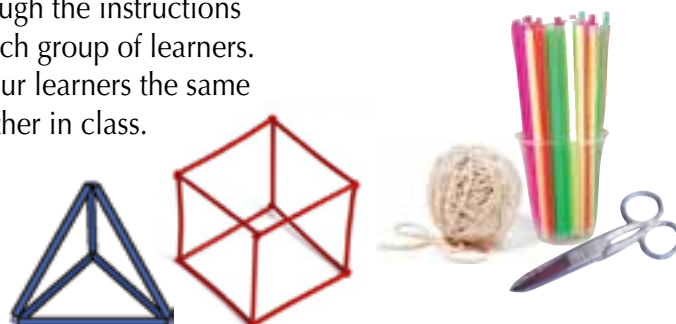

#### Note:

There is a wonderful trick for getting the string through the straw. All you have to do is put one end into the straw, then hold the other end of the string, allowing enough string to go through the straw, and then suck.

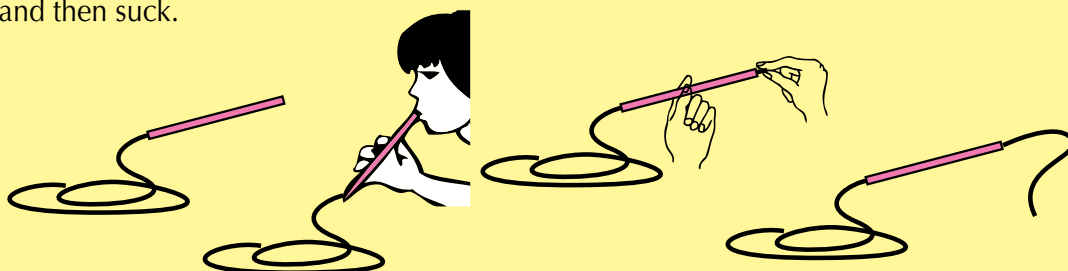

### Building a tetrahedron

#### Step 1

Take 3 straws and feed the string through all of them. Form them into a triangle and tie the ends of the string in a tight knot. Be sure to make the joints tight, but not tight enough to bend the straws. Do not cut off the extra string yet.

#### Step 2

Cut a piece of string long enough for two straws and a knot at each end. Tie it to one of the vertexes of the completed triangle. Feed two straws over this thread and tie a nice snug knot at the other vertex. You should now have a diamond shape with one (and only one) straw across the middle.

#### Step 3

Now tie a string to one of the points of the diamond where only two straws meet, thread a straw onto it, and tie a snug knot at the opposite point of the diamond. You can now trim off all the excess string, but don't cut it so short that the knot comes undone. Your finished shape should look like this and is a tetrahedron (a pyramid made with 4 equilateral triangles).

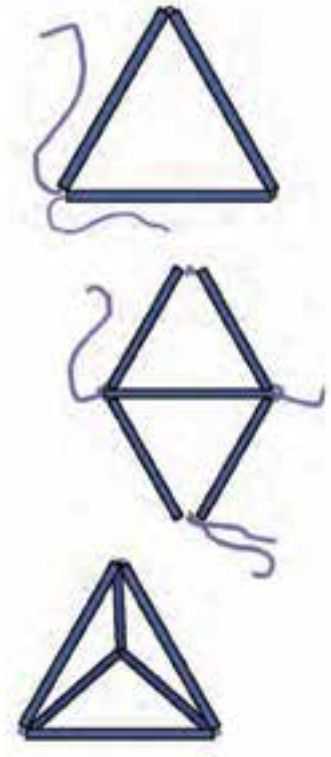



## Grade 3: Space and shape (geometry)

### Skills and knowledge

#### The learner:

- Determines lines of symmetry in two-dimensional shapes using paper folding and reflection.

### Suggested activities

Before you begin, read through the symmetry activities suggested for previous grades. Repeat any activities that you think your learners will benefit from.

#### Collecting symmetrical objects

This should be an ongoing activity where learners look for objects and pictures around them that have different kinds of symmetry. These can be natural objects, found objects or drawings of symmetrical objects. Hold class discussions where learners take turns describing their collections and pointing out where the lines (axes) of symmetry are.

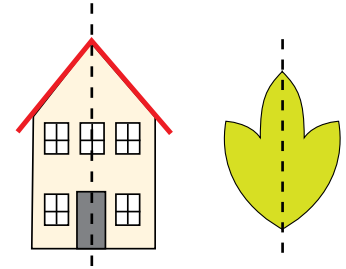

#### Symmetry in African artefacts

Collect examples of African artefacts or pictures of such artefacts. Use them to introduce discussion about the symmetry often found in African designs. Ask learners to say in which way the objects are symmetrical and to indicate where the 'imaginary' line divides the object in two or more symmetrical parts.

Show examples like these:



You can make copies of the worksheet on page 370.

#### More about symmetry in 3-D objects

Use 3-D blocks, cardboard models or other 3-D objects for learners to identify lines of symmetry. Show lines of symmetry across a rectangular prism, a triangular prism and a cylinder. If you have a set of blocks of different and proportional sizes, have learners use two or more smaller blocks to build a larger block made of two or four smaller blocks and to identify where the line(s) of symmetry are.

Learners should understand that two symmetrical halves are fractions of the whole.

For example:



#### Cross-section symmetry

In a previous activity, learners made models of 3-D figures and then cut them through the middle, down the middle or diagonally, to investigate what shapes they got each time. This same activity can be used to help learners identify which of the objects have vertical, horizontal or diagonal symmetry and which of the objects have no symmetry.

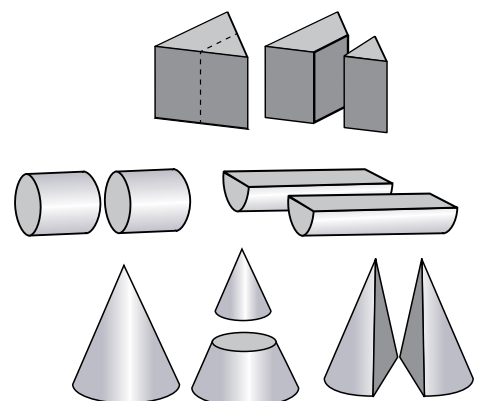

## Grade 3: Space and shape (geometry)

### Draw the other half

Design practice worksheets with half-drawn pictures. Learners must complete the other half of the picture along different symmetry lines.

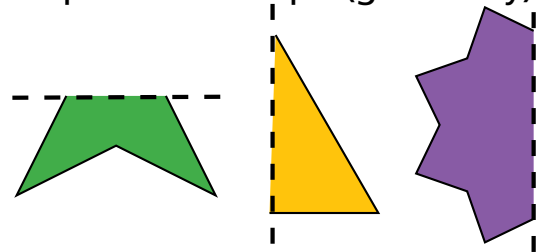

They can do this by holding a mirror along the symmetry line to see what the reflection looks like first.

Repeat the same kind of activity but this time show the half-drawn picture on grid paper. Learners must then follow the shape and the grid lines to draw the rest of the drawing.

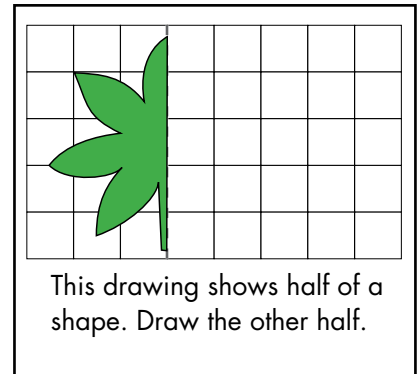

### Folding and cutting

Build on previous suggestions for paper folding activities. First let learners experiment by folding pieces of paper in half once or twice, cutting out simple designs and then unfolding their paper and examining their designs. Let them use small mirrors to check for symmetry along their fold lines (or lines of symmetry).

At a later stage you can fold pieces of paper in different directions, cut out simple designs and ask your learners to visualise and draw what they think the unfolded paper will look like.

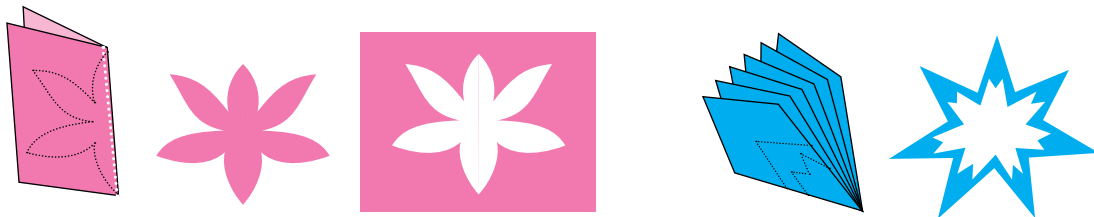
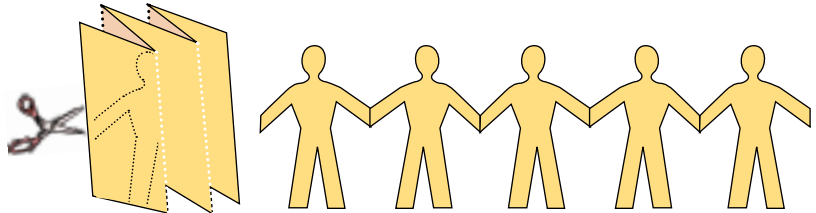

### Symmetrical block patterns

Make worksheets on grid paper with a shape like this. Ask learners to find as many different ways as they can to extend the shape to make it symmetrical.

They can do this by placing a small mirror along the shape and looking for all the possible reflections.

They then copy the original shape in the grid a few times, and draw the halves they saw reflected by the mirror.

Learners could do the same activity using small unit cube blocks.

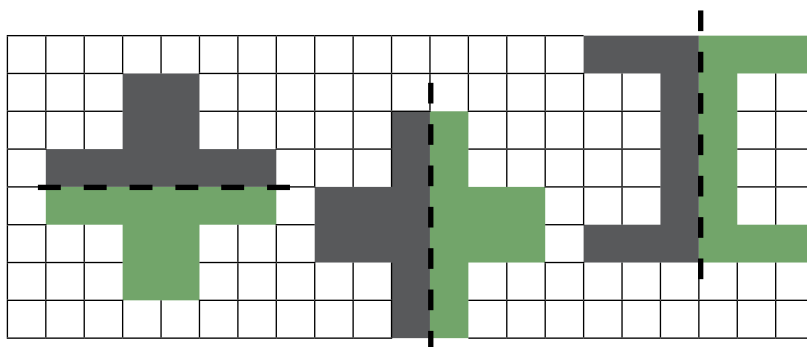
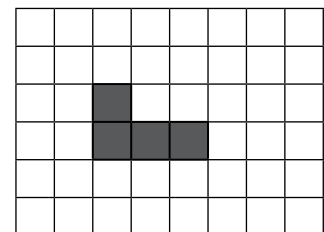

## Grade 3: Space and shape (geometry)

### Symmetrical letters and words

Have learners analyse the lines of symmetry in the capital letters of our alphabet. Let them use mirrors to check for the lines of symmetry. They can then work through all the other letters of the alphabet and identify which of them are symmetrical and identify in which direction the symmetry falls. Follow this up by challenging them to predict what the folded shape will look like.

Look at the letters.

**A B C G K M Q X O H N**

Some of the letters have no lines of symmetry (fold lines), some have one line of symmetry, some have two lines of symmetry and one of the letters has more than 2 lines of symmetry.

Write the letters in the correct column in this table:

0 lines of symmetry	1 line of symmetry	2 lines of symmetry	more than 2 lines of symmetry

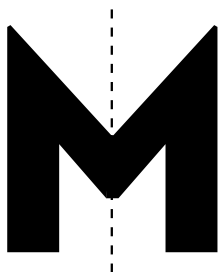

We fold this shape down the middle on the foldline.

What will the folded shape look like?

Tick (✓) the correct shape.

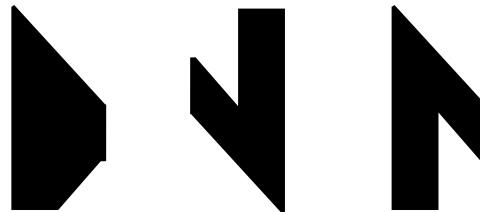

### Symmetrical words

- Words like these are symmetrical.



- Ask learners to use what they learned in the previous investigation to find more words that are symmetrical - in both English and in other languages that they know.

### Creating symmetrical shape patterns

- Give pattern blocks or geometric cardboard cut-outs to each group. They must use these to create symmetrical patterns.
- Talk about the differences in the symmetry of designs. Design A has the symmetry line down the middle of the hexagon, as there is an odd number of shapes. Design B uses an even number of shapes, which means that the symmetry line lies between the repeating patterns of the shapes on either side.

Design A

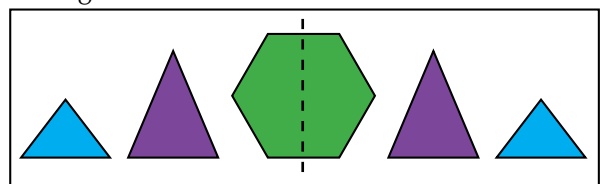

Design B

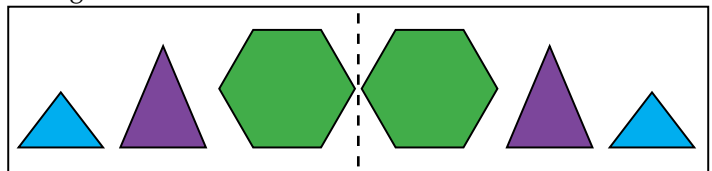

### Folding shapes

Make enough cut-outs of squares, circles, triangles and rectangles for each learner.

- Ask them to fold the shapes in different ways and to find out which fold lines produce two symmetrical halves and which don't.
- Use the square as an example to show learners how some shapes can be folded in four different ways to produce two symmetrical parts.

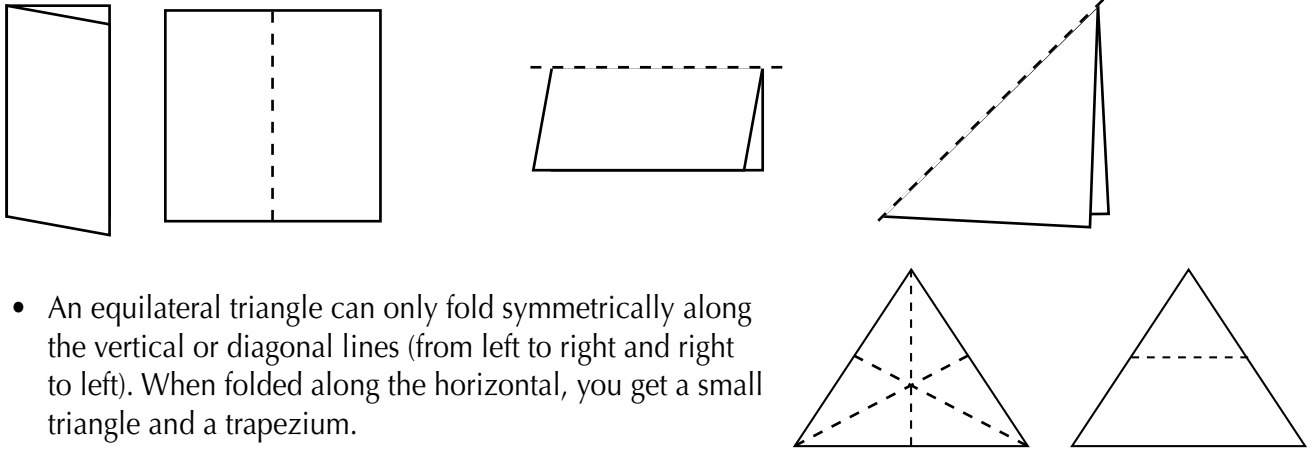

- An equilateral triangle can only fold symmetrically along the vertical or diagonal lines (from left to right and right to left). When folded along the horizontal, you get a small triangle and a trapezium.

### Worksheets

After doing practical activities, prepare worksheets like these to help consolidate what has been learnt so far.

Draw dotted lines to show where the lines of symmetry are on these shapes.

Which of these dotted lines divide these shapes into two symmetrical halves?

## Grade 3: Space and shape (geometry)

### Drawing symmetrical shapes on a grid

Give examples where learners must draw the other half of a 2-D shape on a grid, but in an unusual orientation.

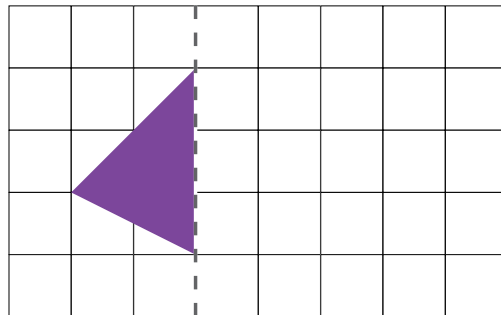

### Review

From these investigations, learners will see that 2-D shapes can have vertical, horizontal or diagonal symmetry or no symmetry at all.

- Some shapes have all three kinds of symmetry, like this square.

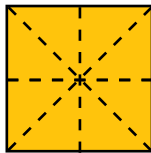

- Some shapes have two kinds of symmetry, like this rectangle.

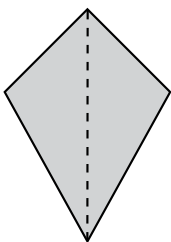
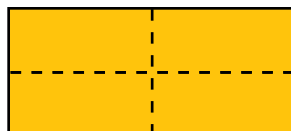

- Some shapes have only one line of symmetry like this kite.

- Irregular 2-D shapes like these are asymmetrical.

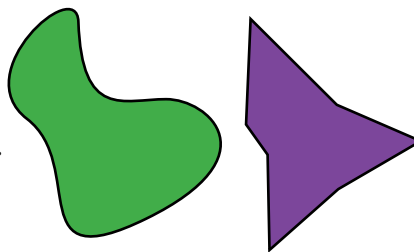

### Generalising rules

- By now some learners may have noticed a link between the number of lines of symmetry a 2-D shape has, and the number of equal sides it has. Or, in the case of a shape like a star, there is a relationship between the number of points and the number of lines of symmetry.
- Help learners to investigate these relationships further. Make a worksheet with a familiar set of regular polygons (closed shapes with straight edges of equal length). Ask them to look at each one closely and to draw in all the possible lines of symmetry.
- Then ask learners if they can describe a rule or a pattern for the number of symmetry lines for the different shapes.

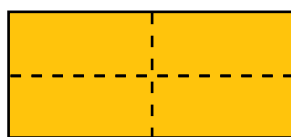
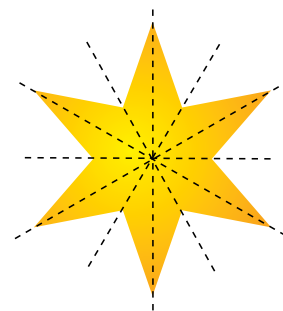

rectangle

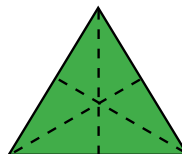

triangle

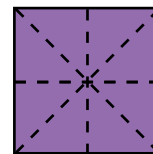

square

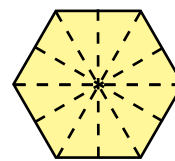

hexagon

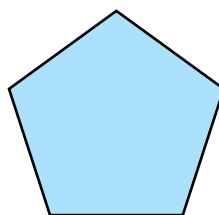

pentagon

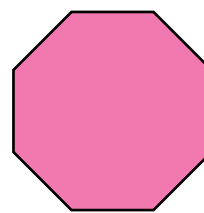

octagon

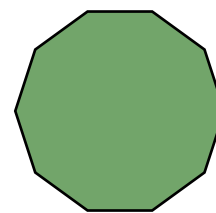

decagon

- Learners should see a relationship between the number of lines of symmetry of a given shape and its corresponding number of equal sides. Give them more examples of regular polygons to test this out. Make each group of learners some large-sized copies of these polygons. Tell them in this case, the edges (sides) of each shape are equal in length. They can use their rulers to check.

## Grade 3: Space and shape (geometry)

- Ask learners to predict how many lines of symmetry each shape will have and to explain how they know. Once they have discussed this, give out copies of the same shape with all the lines of symmetry drawn in for them to check their predictions.

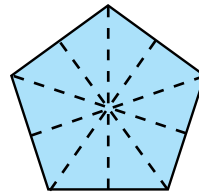

pentagon

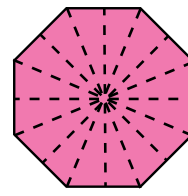

octagon

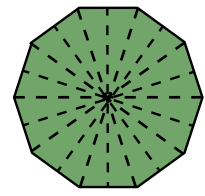

decagon

You can use copies of the worksheet on page 372

### Symmetry in flags

Learners will enjoy looking for different line symmetry in different African flag designs.

As a follow-up activity learners can design their own rectangular flags, that show examples of different kinds of symmetry.

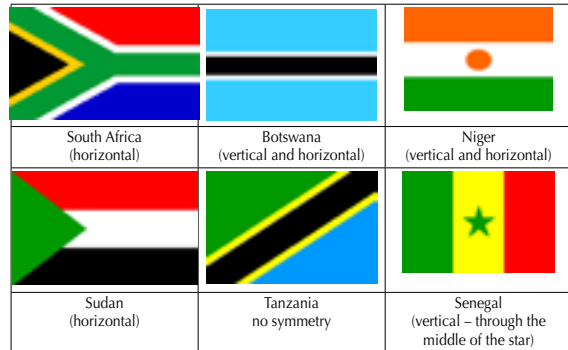

## Skills and knowledge

### The learner:

- Recognises and describes three-dimensional objects from different positions.
- Reads, interprets and draws informal maps of the school environment or of an arrangement of three-dimensional objects and locates objects on the map.
- Describes positional relationships (alone and /or as a member of a group or team) between three-dimensional objects or self and a peer.

## Suggested activities

Read through activities linked to position in space in the Grade 2 work. Repeat any that you think learners still need to do to build their understanding of positions and views. Map work is an added area of study for Grade 3, but some groundwork may have been done in Grade 2.

### Writing positional words

Prepare worksheets with pictures and simple sentences for learners to complete by choosing the correct positional word.

#### Examples:

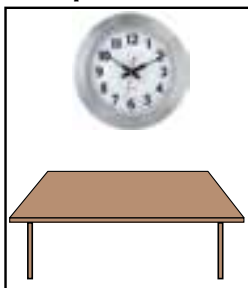

The clock is (above) the table.

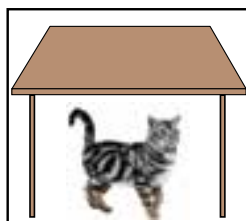

The cat is (under) the table.

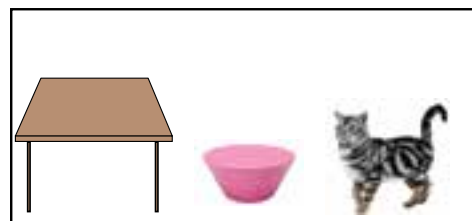

The bowl is (between) the cat and the table.

The activity can first be done in learners' home language if this differs from your language of instruction.



## Grade 3: Space and shape (geometry)

### Who stands where?

- Design activity cards with objects and people in different positions and ask learners to describe them. Ask questions that focus on both position words and ordinals. For example:
  - Who is second last in the queue?
  - Who is two from the front?
  - Who is in the middle?
  - Who is two before Pam?
- Make up examples of word problems or describe a scene like this to your learners:
  - Four children stand in a row.
  - Pumla stands between Yusuf and Abel.
  - Mark stands at the back.
  - Mark stands next to Abel.
  - Write the names of the children in order from the front to the back of the row.
- If they can do these, add more children. For example:
  - Eight children stand in a row.
  - Debbie is last in the row.
  - Mara is two in front of Debbie.
  - Neo is two in front of Mara.
  - David stands between Mara and Neo.
  - Abel is between Yusuf and Gilda.
  - Tshepo stands behind Mara.
  - Yusuf is in the front.
  - Write the names of the children in order from the front to the back of the row.

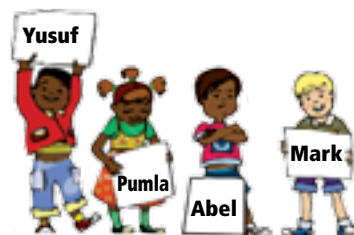
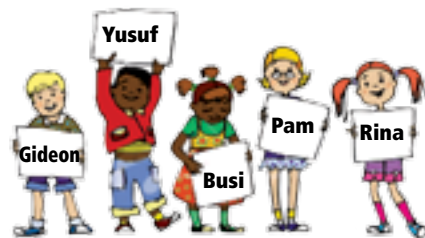

### Moving arrows

Read the activities suggested for Grade 2 for arrow charts to develop learners' understanding of clockwise and anti-clockwise movements and half and quarter turns. Introduce three-quarter turns as well.

Let learners do the activity practically using body movements. Then they can fill in worksheets or work cards that you have prepared like these:

Move the arrow a quarter turn in a clockwise direction. Show where you land.	Move the arrow a quarter turn in an anti-clockwise direction. Show where you land.	Make a three-quarter turn in a clockwise direction. Show where you land.	Make a three-quarter turn in an anti-clockwise direction. Show where you land.

### From where I sit

Give each learner a piece of paper and explain that it represents the floor plan of the classroom. They must make a cross on the page to show where they sit in the classroom. They then mark or draw arrows to point in the direction of where their friends sit, or where the teacher stands, or where her table is, or where other landmarks like the board or the door are. They can label and name these positions.

## Mapping the classroom

Organise learners to work in groups to make a map of the classroom with small 3-D objects, like playing blocks, or with their rulers, sharpeners or rubbers. Discuss which landmarks in the room are important to include in the map and which are not.

The whole map should cover a space more or less the size of an A3 sheet, like the top of a school desk.

Give some guidance to help learners choose the correct-sized objects to show different things. For example use a rectangular block for a table and a smaller cubed block for the chair to show their relative sizes. Encourage learners to also think about how close or far from each other the objects are and to show this on their maps. This informally introduces them to the concept of scale.

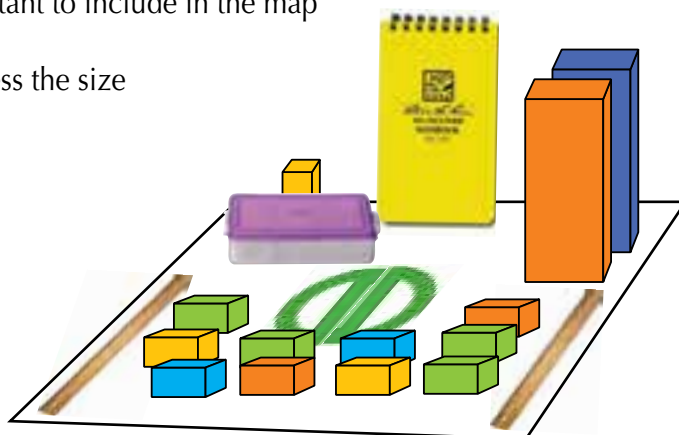

- Give each learner a sheet of A3 paper. Tell them that this represents the floor size of the classroom. This time they are going to draw a flat floor plan of the classroom, by tracing around the base of the 3-D objects they used in the first map.
- On another sheet of paper, they trace around each object. They cut the shapes out and paste each one on their A3 sheet, in the place that corresponds to the position of their original 3-D objects.
- Talk about how, on their plans, each shape marks the position and outline of the objects they used to show the location of important items in the classroom.
- Introduce the expression 'bird's eye view' by explaining that if, like a bird, they were flying high above the classroom and looked down, they would see this flat version of the map, with only the outlines of the objects visible.

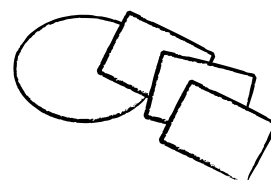
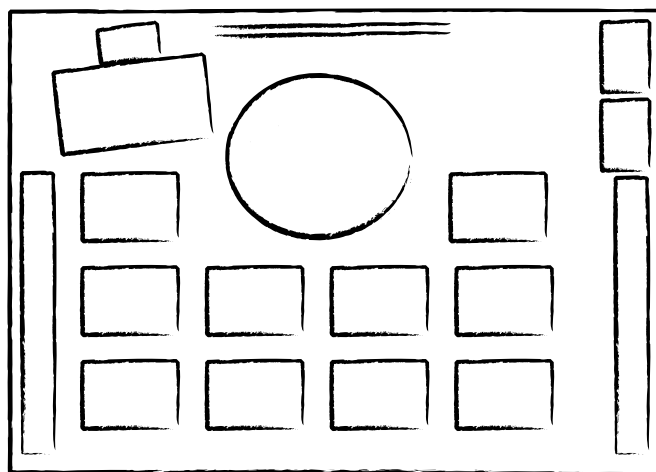

As an expanded opportunity, learners can re-plot their classroom maps on a sheet of grid paper like this, for example:

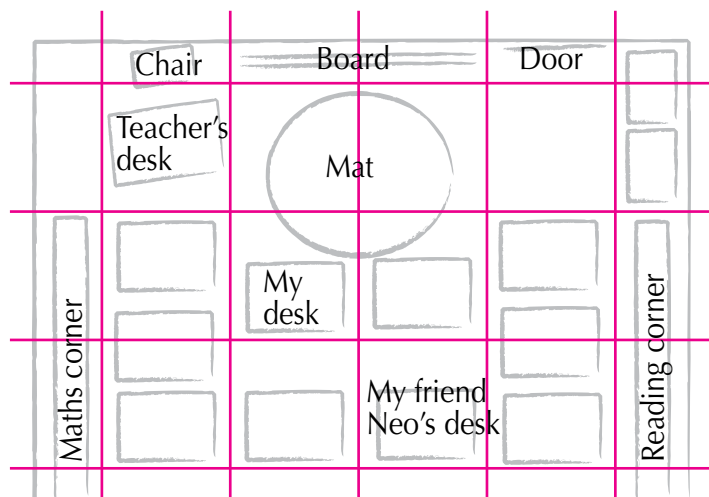

## Grade 3: Space and shape (geometry)

### Describe your route

- Tell learners about the journey you take to get to school. Describe some of the things you see along the way, using left and right and other position and direction words.
- Next give learners a chance to describe their school routes to one another. Let them draw pictures of their journeys in a few frames to show some of the important landmarks they see along their route.

I turn left as I go out my gate and then I take the bus on the opposite side of the road. The bus travels down the road and takes a first left where the café is and second right at the church. It travels three blocks down and drops me in front of the school gate.

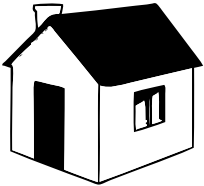

### From here to there

Give each learner a sheet of 2 cm square grid paper. Mark the school in one block and a house in another.

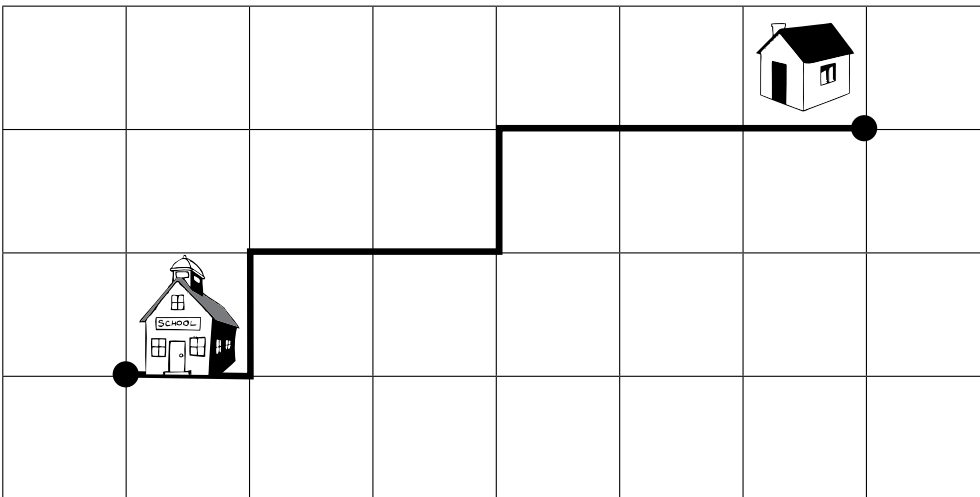

- The object of the activity is for learners to use a pencil to show different routes they can take to get from home to school. The rule is that they can only move around the edges of the blocks, not through the blocks.
- Make time for learners to discuss and compare their different routes in their groups. Note whether they use left and right correctly, as well as other positional words like up, down, to the left side, to the right side.

### Finding your way

Use the same grid as above, but add in some additional landmarks.

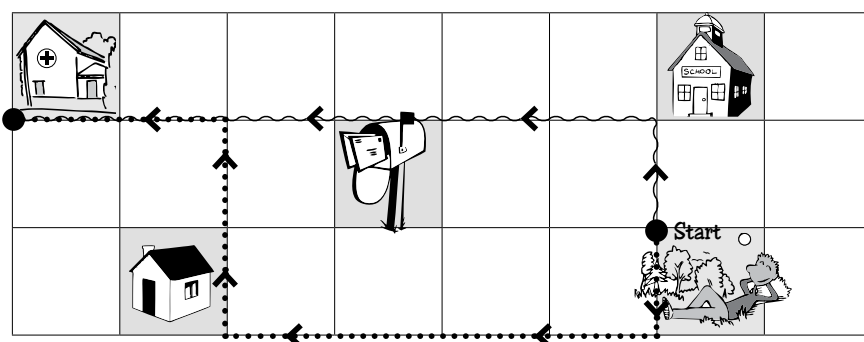

I walk one block up to the school, turn to my left, walk six blocks down and the clinic is right here!

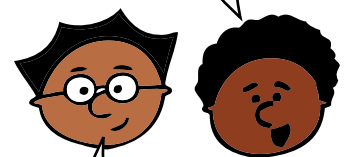

To get from the park to the clinic, I go through the park, turn right, and walk four blocks. I turn right and walk two rows up, turn to my left, walk two blocks and here I am!

### Draw what you see

- Learners work in groups of four around a table. Give each group a rectangular block or used carton to draw from different viewing positions.
- Starting out from where they're seated, they draw the first view they see. They then move one place around and draw the next view they see.
- They continue moving around the table until they have a picture of all four side views. They can then all draw the view from above. They must not talk to each other or share their pictures yet.
- Once each learner has drawn all five views, they can begin to compare and discuss their drawings. They must check one another to see that they all saw the same shape from each of the five positions.
- Of course the drawings will differ in levels of accuracy. That does not matter, as long as they show that the two opposite rectangular faces are the same.

### Drawing views of block models

Give learners small cubes to build different models.

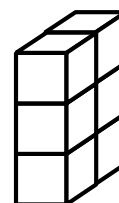
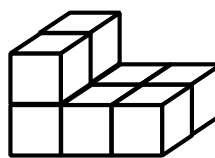
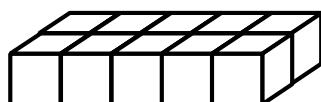
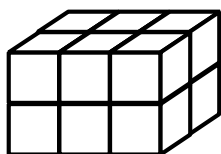

They must then look at their models from the sides and from above and draw the arrangement of blocks they see. They label each view to show if it is one of the sides or the top.

Model A

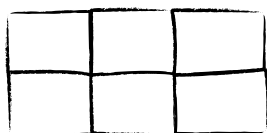
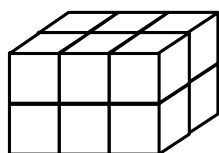

top view

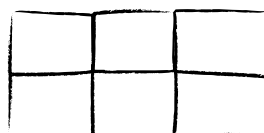

front view

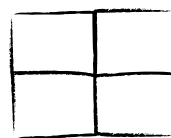

side view

Model B

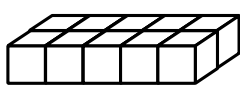

top view



front view



side view

### Block views on grids

- First check that learners have shown their views with the correct number of blocks each time. Do not focus on the accuracy of their drawings. They are only meant to be sketchy at this stage.
- Next give each child a sheet of grid paper and have them copy the views and their drawings by shading in the correct number of blocks on the grid. Here their drawings should be more accurate and neater. They should also label each one correctly.

Model B

		Front view		
		Top view		

## Grade 3: Space and shape (geometry)

### Back to position

#### Picture the scene

- Describe a scene like this to your learners. They must listen carefully and imagine the positions of the people and the objects you describe. They must then draw the scene on a piece of paper.

Buthi and Pumla can see a chair in the middle of the long edge of the table. From where Buthi stands, he sees the back of the chair. From where Pumla stands, she sees the front of the chair. Who stands where? Draw a picture or a map of the scene to show your answer.



- Show them how to use symbols and draw simple sketches to show the different people or objects, rather than draw them in detail. For example:

When the chair is facing the back.

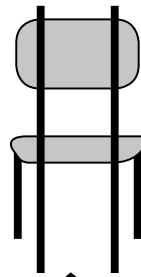

When the chair is facing the front.

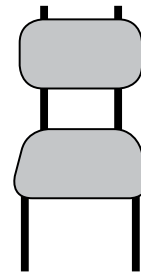

#### Views from different positions

Explain to the learners that A and B represent two viewing positions. Ask questions like:

- When you stand in Position A, which object do you see to the left of the tree? And to the right of the tree?
- When you stand in Position B, which object do you see to the left of the tree? And to the right of the tree?

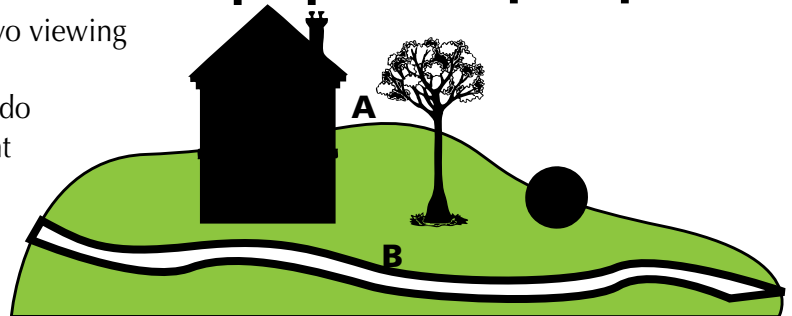

Learners should understand and be able to explain, that it is not the position of the objects that change, but the position of the viewer. What the viewer sees will be in reverse order when looked at from opposite sides.

If learners struggle to visualise changes of relative position according to different viewing points on pictures, give them more practical experiences. For example, let them walk around objects on a table and describe relative positions as they move around. They can also draw what they see at different points.

#### Toilet roll cameras

- Give learners more opportunities to use toilet roll or carton roll 'cameras' to look at objects from far and from close up and then talk about them.
- Use different-sized cameras made from other cylinders like fax paper or paper towel rolls, or make examples from cardboard or paper.
- Learners can then experiment with these cameras to look at close-up and far away views and discuss and compare what they see.
- Have them do drawings of one scene that they viewed through the cylinders, from close up and from far away.

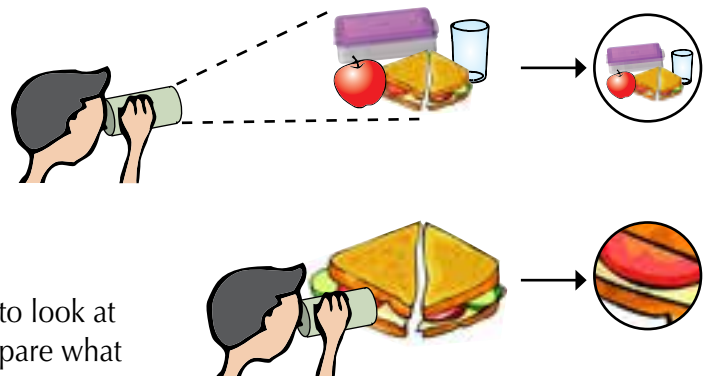

#### Close-up pictures

- Use your cell phone to capture and download images that show familiar things from unusual views.

## Grade 3: Space and shape (geometry)

- You can also find examples in magazines and newspapers.
- Paste the images onto cardboard to make up set of cards. Learners play in pairs or in their groups to take turns guessing what each picture shows.
- In a follow-up lesson, let learners choose their own objects to draw from close-up positions.



### Puzzling pictures

Use examples like these to get learners to predict what they will see if they look at an object or a scene from a particular viewing position.

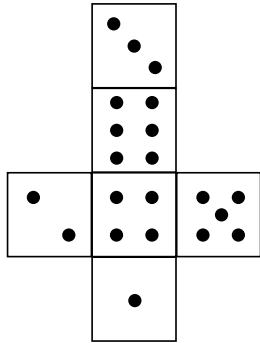

Kabelo folds this shape into a dice. What will Kabelo's dice look like?

Tick (✓) the correct dice.

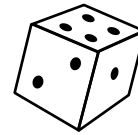
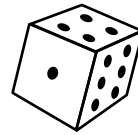
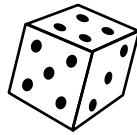
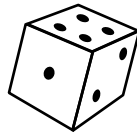

Tammy looks at her suitcase. What shape does she see?

Tick (✓) the correct shape.

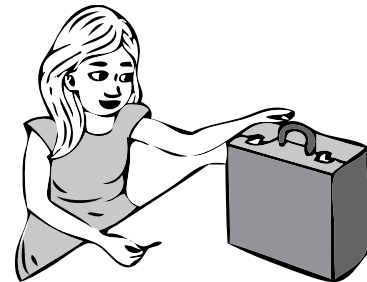
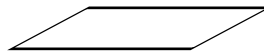
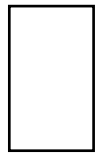
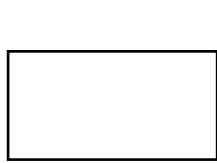

Martha lies underneath the glass table. What shape does Martha see?

Tick (✓) the correct shape.

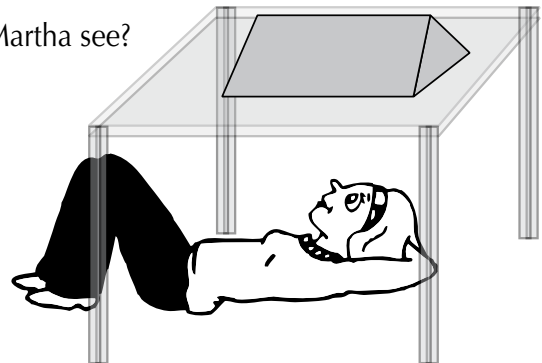
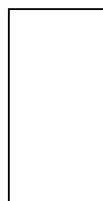
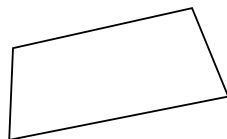
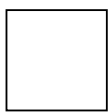

### Positions in a grid

- In Grade 2 we suggested an introductory grid activity to help learners interpret positions on a grid and use words like: top, bottom, to the side, above, under, next to, left hand and right hand. See if they can name the different positions by saying things like, "The telephone is below the head phones", or "in between the plane and the flower". They should also use left and right. For example, "The bell is in the top left hand block of the grid", or "the flower is in the bottom right hand corner".
- Next extend the kinds of questions using a range of different positional words, like:  
Which object is:
  - between the scissors and the pen?
  - directly above the phone?
  - above left or above right of the phone?





## Grade 3: Space and shape (geometry)

- two to the right of the scissors?
- one to the left of the clock?
- Then introduce 2-step positions like:  
Which object is:
  - two up from the phone and one to the right or left?
  - two to the left of the flower and two up?

### Introducing rows and columns

- Introduce the words, 'rows' and 'columns'. Show learners how the rows run across from left to right and the columns run up or down. Where the lines meet, they form blocks to make a table. Give them an example to show how to name the position of any picture in the grid by using both columns and rows. For example: "The bell is in the first row and the first column." Ask them to name other pictures in the same way. For example:
  - The one in the first row and the second column.
  - The one in the 3<sup>rd</sup> column and the 2<sup>nd</sup> row.
- Help learners to see links between the grid arrangement and multiplication,  
i.e. 4 rows with 3 pictures in each row make 12 (4 x 3) and  
3 columns with 4 pictures in each column, makes 12 (3 x 4).

### Make your own grid games

- On a large sheet of paper, draw a grid with 12 - 16 blocks, each measuring at least 4 cm x 4 cm. Make enough copies for all your groups. Paste each grid on a firm piece of cardboard to make a playing board.
- Collect pictures from a magazine or from used greeting cards. They should be more or less the size of the blocks in the grid. Paste the pictures on to a blank grid and then cut them out to make a set of pictures, one for each block. Keep the pictures together in an envelope.  
You can also use 12 - 16 small objects, e.g. a paper clip, a button, a stone, a sharpener.
- Each group of learners gets one board and one set of cards or objects.  
Here are suggestions for three inter-related games they could play:

#### Game 1

- Each learner has a turn to choose a picture or object and place it anywhere on the grid. They must say where it is, using rows and columns.
- They take turns to do this until all the blocks are covered with pictures or objects. Other learners in the group must agree to the position or suggest changes.

#### Game 2

- Let learners play in pairs or smaller groups. They start by covering the grid with pictures or objects. They take turns to think of a picture or object and then name its grid position. The other group members must identify which picture or object was chosen.

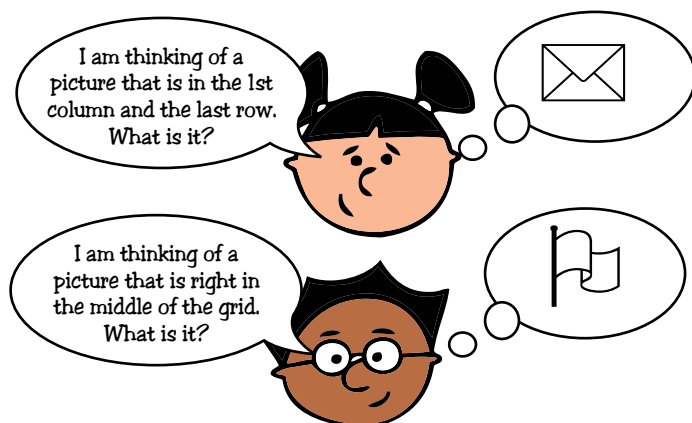
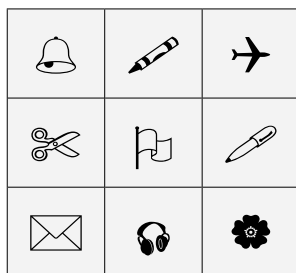

## Grade 3: Space and shape (geometry)

### Game 3

- To begin with learners must place pictures or objects in all of the blocks on the grid and memorise their positions. They then remove the cards from the grid, shuffle them and place them in a pile, face down.
- Each learner has a chance to turn over a card and say where it must go. The rest of the group must first listen and then decide if the position is correct. If not they should agree together where it goes. The game ends when the 2<sup>nd</sup> last card is on the grid.

I am going to put this flower in the 3rd column in the 3rd row.

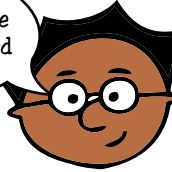

I am putting this crayon in the 2nd column in the 1st row.

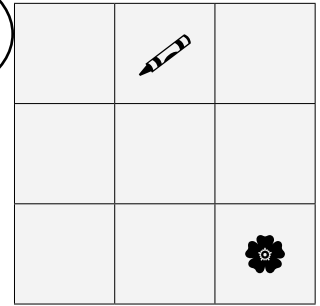

### Back to floor plans

- Make up a worksheet with drawings of different block towers made with interlocking unit cubes. Provide floor plans for the different models in a jumbled order. Learners must match the correct floor plan with each model.
- Next give each group of learners a pile of unit cube blocks to build their own towers. They can work in pairs.
- Each learner takes turns to build a tower, then asks their partner to predict and then draw what they think the floor plan of the tower will look like.

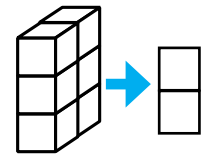
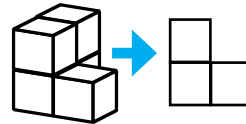

### From the bottom up

Give learners floor plans and then ask them to build towers to match the floor plans using a specified number of blocks to do this.

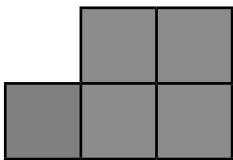

Use nine blocks to build a tower on this floor plan

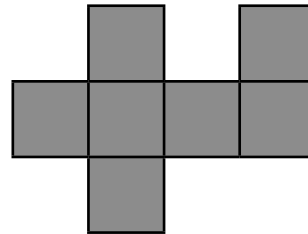

Use 18 blocks to build a block tower on this floor plan

### Coding floor plans

- Some learners will be ready to use a system to draw and number floor plans and the height of different parts of the block buildings as follows:

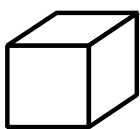

Floor plan

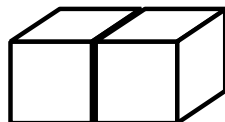

Floor plan

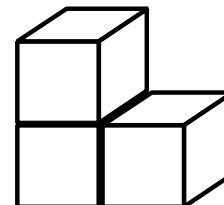
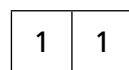

Floor plan

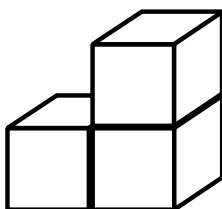
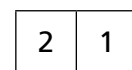

Floor plan

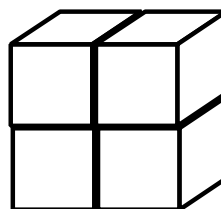
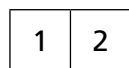

Floor plan

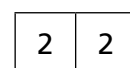

## Grade 3: Space and shape (geometry)

- Take learners through the plans one by one. Ask them to build the models and then show them how to draw the floor plans on the board.
- Challenge them to build and then draw floor plans for more complex models like these:

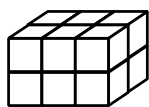

Floor plan

2	2	2
2	2	2

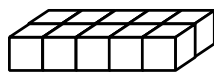

Floor plan

1	1	1	1	1
1	1	1	1	1

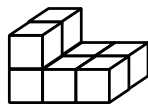

Floor plan

2	1	1
2	1	1

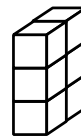

Floor plan

3
3

### Drawing maps in the sand

- Let learners look for sticks they can use to draw map outlines for small villages or towns. Organise it so learners can work in their own spaces where their maps don't overlap.
- They first draw the outline of the map, with paths and roads and then use stones or other materials to show landmarks like the school, the shop or the bank.
- Make time for learners to describe their maps to one another. Ask them questions which they must answer using words of position.
- Before going back to class, ask learners to make rough sketches of their maps. Back in class they can make more detailed drawings of their maps to show some of the key landmarks, which they can also label.

### Street maps

- Draw a map of your local area on an overhead transparency. Use a real map, even of an unfamiliar area, to help you do this as accurately as you can. Using a scale to get the proportions right. Focus on the outline, the streets and two landmarks, like the nearest shop and the school building. Learners must say where other landmarks are.
- Project the map onto the board or wall. If you do not have an overhead projector, you can make paper copies for learners to work with in groups or pairs.
- Ask learners questions where they have to place different landmarks on the map, either using non-permanent overhead markers or on their copies.
- Ask questions that guide learners to describe different routes from point A to point B. Have them then describe the journey in reverse from B to A. If necessary, remind them that on their return what was on their left will now be on their right.



**Exploring and comparing maps**

- Make a collection of different kinds of maps, from garages, shopping centres, theme parks and tourist information offices and some story books. Have the maps available in the reading corner for learners to look at and discuss. Ask questions about the different maps to find out which of the maps they found easy to read, which they liked best and why.
- Give them the opportunity to try and copy some of the maps and describe different routes from one point to another.

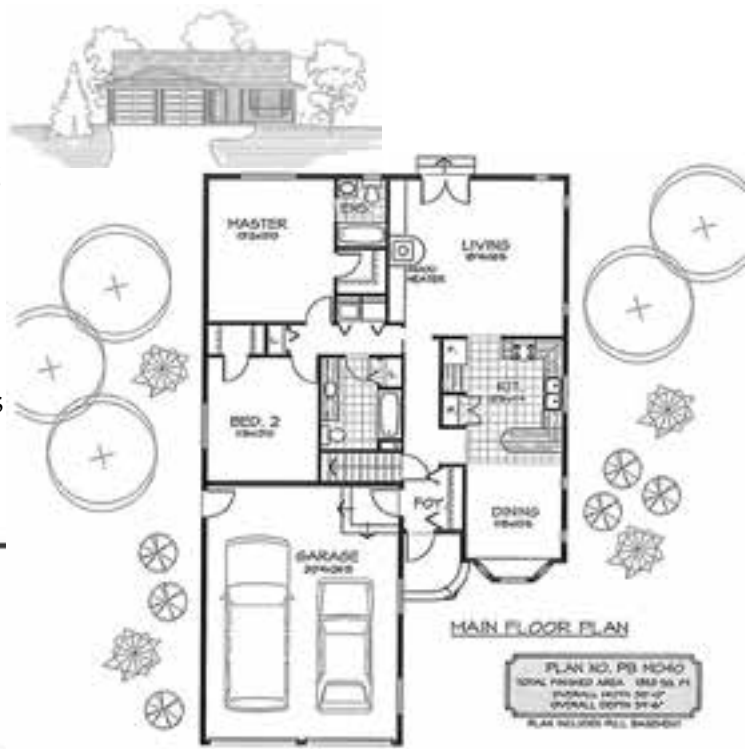

**A number line of rectangles**

Work in groups.

Using paper or tile squares, learners will make rectangles of different sizes. Be sure that learners understand what a rectangle is, and that a square is a special kind of rectangle. You could use a Carroll Diagram to demonstrate examples of rectangles and 'not rectangles'.

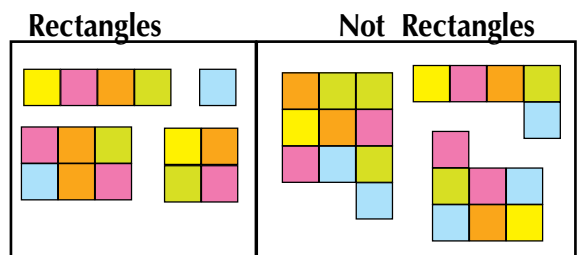

- If you are making rectangles out of these squares, what is the smallest rectangle you can make? (One square.)
- The next size rectangle you could make has two squares, which you could draw – either this way – or this way
- Since they are really the same shape, we are only going to count that as one kind of rectangle.
- There's also only one rectangle you can make from three squares.
- But when it comes to four, we discover there are two different shaped rectangles we can make.

## Grade 3: Space and shape (geometry)

Have each group cut out these 5 rectangles – one each using 1, 2, and 3 squares, and 2 using 4 squares. They must display the rectangles on their number lines, like this:

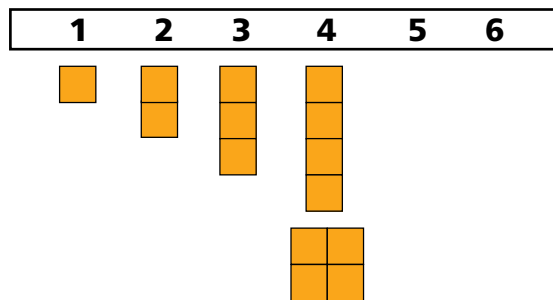

Let the learners continue the process of finding all the different rectangles that can be made using each number up to 24. Groups will work at different rates. It's not necessary for all the groups to finish all 24 steps as long as they have spent the time engaged in exploring, and all groups have made it more than half way to 24.

This works best if learners have tiles or grid paper where each square is 2 or  $2\frac{1}{2}$  cm. The exact size isn't important as the area of a square and the length of the side of a square will be used later as non-standard units. To conserve paper, encourage learners to form rectangles by joining smaller pieces together with sellotape.

Draw learners' attention to the fact that each rectangle is also a picture of a multiplication problem. Look at the number 4, for example. How many multiplication problems have an answer of 4? There is  $1 \times 4$  and there is  $2 \times 2$ . And there are two rectangles made up of four squares. One is  $1 \times 4$  and the other is  $2 \times 2$ .

The rectangles are also pictures of division problems. What is 12 divided by six?

If we look at the  $2 \times 6$  rectangle we can see that if we divide 12 squares into six rows there are 2 in each row. But if we divide 12 into two columns there are 6 in each column.

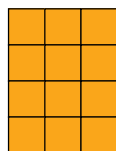

And if we look at the  $3 \times 4$  rectangle, we can see that if we divide 12 squares into 4 rows there are 3 in each row, and if we divide 12 squares into 3 columns, each column will have 4 squares.

There are many interesting explorations learners can do. One very interesting one is to look at the area and perimeter for the numbers that have both square and non-square rectangles, to see if they can discover a pattern. To do this they will collect their data in a table.

Learners could display the rectangles on a number line in order of increasing area. What other ways could these rectangles be arranged?

### Vocabulary

If you do not teach in English, use equivalents in your language of instruction.

#### Grade 1:

- understand and use these words in practical contexts:
- shape, pattern, flat, curved, round, straight
- solid, corner, face, edge
- rounded, pointed
- roll, slide
- build
- everyday language to name and sort properties of 3-D objects and 2-D shapes such as cubes, spheres, circles, triangles, rectangles (squares)
- front, back, right, left, midline
- top, bottom, across, up and down, from side to side
- down the middle, across the middle, midline
- reflect, mirror, dotted line, equal parts or halves
- in front of, behind, side, next to, beside, on top of, above, underneath, below, inside, outside, to the left of, to the right of, left hand side, right hand side
- to, from, towards, away from, over, under, underneath, above, below, on, in, outside, inside, in front, behind, beside, before, after, next to, opposite, between, close by, far away, far apart, middle, centre, edge, corner, sideways, up down, forwards, backwards, across, along, around, through.

#### Grade 2 - add the following to the Grade 1 vocabulary:

- rectangular, triangular
- squared prisms
- a square is a special kind of rectangle with all edges the same length
- a square prism, a rectangular prism and a triangular prism
- other names of shapes that they may come across like rhombus (diamond), hexagon, trapezium or kite
- tangram
- symmetry, symmetrical, non-symmetry, non-symmetrical
- views from the front, from the back, from the sides, from the top, position, view, changes, looks different
- quarter turns, half turns, full turns, clockwise, anti-clockwise.

#### Grade 3 - add the following to the Grade 1 and 2 vocabulary:

- balance, not balanced, facing opposite directions
- vertical, horizontal, diagonal
- map, point, distance, aerial view, floor plan
- area, perimeter



## Grade 3: Space and shape (geometry)

### Resources

- 3-D blocks of different shapes and sizes including:
  - cubes, cuboids (rectangular prisms)
  - triangular prisms, spheres and cylinders
- cartons and containers of different shapes and sizes
- other construction materials like Lego
- balls of different sizes and other spherical objects that roll
- coloured shape blocks or paper cut-out shapes that include triangles, rectangles, squares and circles
- geoboards
- examples of a circle, triangle, square and rectangle with labels for the wall
- number cards; shapes; posters and pictures of different 3-D objects and shapes
- play dough, plasticine or other modelling materials
- crayons, paper, string, a feely bag to hide different shapes in
- multilink cubes or similar materials that join together on each side
- full length mirror, small mirrors
- metre stick or straight rod, the length of an average learner's height
- newsprint, crayons, paint, paintbrushes
- collection of objects and pictures that are both symmetrical and asymmetrical
- beads, threading string
- worksheets with half drawn objects that are symmetrical for learners to complete
- arrow chart with a moving arrow
- bean bags
- any objects around the classroom or school environment that learners can easily move into different positions
- songs and rhymes you can use to teach learners the vocabulary of position.

### **Additional resources needed for Grade 2:**

- pictures with different views
- worksheets with block models
- grid paper

### **Additional resources needed for Grade 3:**

- photographs, symmetrical artefacts
- samples of different kinds of maps
- grid picture game boards and cards



The learner will be able to use appropriate measuring units, instruments and formulae in a variety of contexts.

## Skills and knowledge

### The learner:

- Reads and writes analogue and digital clock time in terms of hours, half-hours, quarters of an hour and minutes.
- Solves problems involving calculations with and conversions between:
  - a) minutes ↔ hours
  - b) hours ↔ days
  - c) days ↔ months.

The vocabulary that learners need to understand and use these skills is listed at the end of the suggested activities. You will find it helpful to make flash cards with key vocabulary words to support the teaching and learning process. A list of the resources you will need for the activities is also provided.

## Suggested activities

### Reading time

#### Using a story about time

Tell learners a story about a little boy who never learned to read a clock with hands. In his house there were only digital clocks with numbers. He could always tell the time from the digital clocks, so he didn't bother learning to read time on the clocks with hands. One day he learns that his grandfather has died, but before he died he said that he wanted the little boy to have his fine old wristwatch. The boy loves the gift from his grandfather, but he doesn't know how to use it to tell time.

Have the learners write a letter to the boy explaining to him how to tell time using the wristwatch with hands. Encourage them to illustrate the letter with pictures.

You can use this activity to assess whether your learners can read time and to consolidate their knowledge.

#### Paper plate clocks

- Have learners make their own clocks using a paper plate for the face of the clock, cutting the long minute hand and the short hour hand from strips of cardboard, and connecting them with a split pin.
- When the numbers have been added to the face of the clock, have learners practise counting by fives, tens, and twenties around the clock face.
- Review the cycles of a.m. and p.m. – using a 12 hour clock to tell time throughout a 24 hour day, and the similarities and differences between clocks with arms and digital clocks.

#### Setting and reading time

Give learners a variety of activities which involve reading the time from the clock or setting the clock to a given time:

- Use flash cards to give learners a particular time, expressed in numbers with a.m. or p.m., in 24 hour notation, or in words, and have them set their clocks to that time.
- Set the demonstration clock to a given time and ask learners to write the time in words and in numbers.

- Have learners take turns leading the activity. The learner chooses a time and describes something he or she likes to do at that time, such as a favourite TV show. He or she writes the time and the other learners must set their clocks to that time. The learner could also set the clock and ask the others to write the time out in analogue or digital format.
- One learner chooses an event or activity and says at what time it occurs. The other learner must set the clock to the appropriate time.
- Working in pairs, one learner sets the clock and says what happens at that time. The other learner must write the time in words and in numbers.
- Give each pair a set of cards with several times shown in different ways – words, numbers using a.m. and p.m., 24 hour notation, and pictured on a clock. Learners work together to match the cards with each other correctly.
- Give each pair a set of cards with a variety of times shown in different ways. Learners must put the cards in order from earliest to latest, e.g. 02:30; 16:15; 04:20; 18:30; six forty-five; etc.



### Time lines

Have learners make timelines of their lives. Show milestones such as when they were born, when they started school, and then find the length of time in years, months and days between important events.

Make timelines of events in stories you are reading, or of historical events, or the lives of historic figures learners are learning about. Calculate the time between events.

### Hours and minutes of daylight and darkness

Here is a schedule of sunrise and sunset times for Johannesburg for the 21<sup>st</sup> of each month.

Ask learners to complete these tasks:

- Calculate the length of the day for each month.
- Calculate the length of the night for each month.
- Say which month has the longest days.
- Say which month has the longest nights.
- Calculate the difference, in hours and minutes, between the longest day and the shortest day.

Johannesburg		
	Sunrise	Sunset
21-Jan	5:35 a.m.	7:04 p.m.
21-Feb	5:57 a.m.	6:46 p.m.
21-Mar	6:12 a.m.	6:18 p.m.
21-Apr	6:27 a.m.	5:47 p.m.
21-May	6:43 a.m.	5:27 p.m.
21-Jun	6:55 a.m.	5:25 p.m.
21-Jul	6:53 a.m.	5:37 p.m.
21-Aug	6:32 a.m.	5:51 p.m.
21-Sep	5:59 a.m.	6:04 p.m.
21-Oct	5:28 a.m.	6:18 p.m.
21-Nov	5:09 a.m.	6:40 p.m.
21-Dec	5:13 a.m.	7:00 p.m.

### Timetables

Give learners a variety of time tables for transportation: bus, train or plane. Use real ones or invent your own. Learners calculate the duration of different journeys or events using starting and finishing times. Have the learners look for patterns in the schedules – which trips go every day, which ones go every 2 hours, every other day.

### Long journeys

Give learners a number of examples of origins and destinations that require long journeys, e.g. sailing from Cape Town to England. Let them use the time tables to find out how long the journey will take. Then give them examples where you give the time of departure and the duration of the trip and they say when they will arrive.

## Grade 3: Measurement

### Imagine a trip!

Have learners plan a fantasy trip they would like to take, and plan a detailed itinerary. You could ask them to write about where they want to go and what they will do there. You could also have them think about the budget for such a trip.

### Sports

Look at the results reported in the sports section of the paper every day, or use local or school results if they are available. Choose events that last seconds, minutes and hours. Use examples of sports or players the learners are already interested in; or choose examples where you can tell them stories about the athlete or the event that will interest them.

Give learners the starting and finishing time and have them find the duration of the sports event; or give them the duration and starting time for them to find the finishing time; or duration and finishing time for them to find the starting time. Ask learners to talk about examples of sports events in their own lives that are measured in minutes, hours, days, weeks, months and years.



### A sleep graph

Have learners write down the time they go to bed and the time they get up and calculate the amount of time they sleep. Make a class graph of this information.

### Discussing time

Use pictures to illustrate activities about learners' daily routines. Ask these kinds of questions about the pictures (or about themselves):

- "It is 18:15. You must have a bath at half past 6. How long before it is time for your bath?"
- "At 19:00 you have supper. You have 5 minutes before your favourite television programme begins at 19:30. How long did it take you to finish your supper?"
- "You watch television for 1 hour from 19:30 and then have to go to bed. What time do you go to bed?"
- "If it takes you 4 hours a day to do your homework, how much time will you spend doing homework in five days? And in a week?"



### Calendar questions:

- "What will the date be next week Saturday?"
- "How many days are left until New Year's day?"

### Age questions:

- "How many months ago were you born?"
- "Work out your age in years, months and days."
- "Give your partner your birth date and ask him/her to work out how old you are."
- "A baby is 867 days old. How old is the baby in years, months and days?"



### Time spent at home, at work, at school and travelling:

- "Mr Smith works 20 days in a month. If he works for three months, how many days does he work? He works from 9 a.m. to 4 p.m. How many hours does he work? How many hours does he work in 60 days?"
- "Lizzy was on school holiday for 4 weeks. How many days was she at home? She watched TV for 3 hours a day. How many minutes per day did she watch TV? How many hours did she watch TV in 4 days?"

- “Mr. Nkosana leaves home at 5 o’clock. He gets to work at 7 o’clock. He stops working at 4 o’clock. How many hours does he work per day? How many hours does he work from Monday to Friday? Work out how many hours he rests before work starts the next day.”

Have learners calculate how many hours they spend at home, at school and travelling per day.

## Fractions of time

### Making clock fractions

Materials for each learner: photocopied clock faces in 6 different colours, straight edge, pencil, scissors.

Print the clock face without numbers onto six different colours of paper and give each learner one clock of each colour. The colours are arbitrary, but the whole class should use the same colour for a given fraction – e.g. blue wholes, red halves, yellow quarters, etc.



See Resources,  
p378

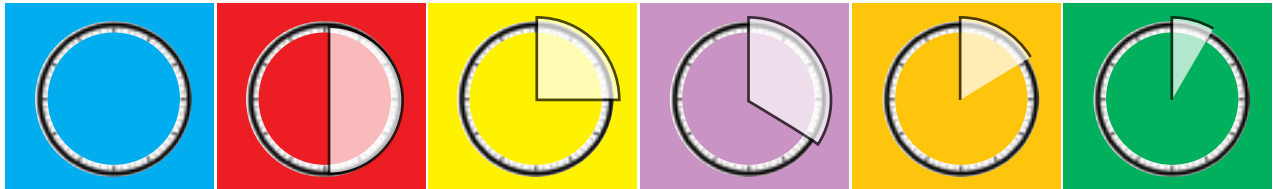

blue - whole

red - half

yellow - quarter

purple -  
third

orange  
10 minutes

green  
5 minutes

- Let learners work alone to make their wholes, halves and quarters. Have extra copies of the different coloured clock faces, in case of mistakes.
- Cut out the blue clock and label it 60 minutes = 1 hour.
- Cut out the red clock, cut it in half (using the markings as a guide) and label each piece 30 minutes =  $\frac{1}{2}$  hour. You can let your learners count out the minutes, in 10s, 5s or 1s.
- Cut out the yellow clocks, cut them into quarters. Be sure to use the markings so that the folds are on the larger 5 minute lines, and label them 15 minutes =  $\frac{1}{4}$  hour.
- Discuss the meaning of fractions – one quarter means one whole divided into 4. How many quarter hours make up one whole hour? If there are 60 minutes in one whole hour, how many minutes in one quarter hour?
- Now have learners work in groups to decide how they will cut the purple clocks into thirds. Have each group explain its method before you have them cut. Once they have a good strategy, have them cut the clock into thirds, count the minutes in each section, and then label each piece 20 minutes =  $\frac{1}{3}$  hour.
- Next have the learners use the same method to cut the orange clock into thirds. Then take one of these thirds and ask the learners how many minutes it is (20) and how many minutes they would have if they cut it in half (10). Have them cut each orange  $\frac{1}{3}$  in half and label each piece 10 minutes.
- Finally, have them cut the green circle in thirds, then cut each  $\frac{1}{3}$  in half, and then ask how many minutes there are in half of a 10 minute segment (5). Have them cut each piece in half and label each resulting 5 minute section.
- Each learner now has clock fraction pieces that make up 6 hours.



## Grade 3: Measurement

The following games are fun and can be played again and again to develop the learners' skill at clock arithmetic and intuition about fractions.

Learners use their sets of clock fraction pieces in the games.

[See Resources](#)

### Adding and subtracting with clock fractions

Either make spinners like this one or prepare minute dice by covering an ordinary die with paper and sellotape and marking the sides  $\frac{1}{2}$  hr,  $\frac{1}{4}$  hr,  $\frac{1}{3}$  hr,  $\frac{3}{4}$  hr, 5 min and 10 min.

The learners take turns spinning the spinner (or rolling the minute die). On each spin they add the amount of time shown on the spinner, converting between minutes and fractions of an hour as appropriate. The winner is the first one to reach the target exactly, without going over.

The first time learners play this, let 1 whole hour be the target. After that, you can choose (or let the learners choose) a different target each time, such as  $2\frac{1}{2}$  hours, or  $3\frac{1}{4}$  hours.

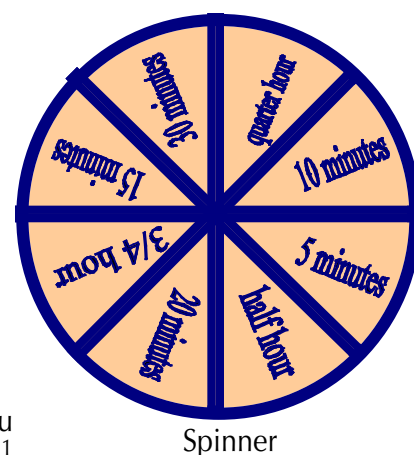

### Multiplication game with clock fractions

The learners take turns spinning the spinner (or rolling the minute die). They then roll an ordinary die. They must work out the number of minutes or the fraction of an hour shown on the spinner, multiplied by the number shown on the die, making conversions where appropriate. They put that amount of time in front of them. The first one to reach 6 hours (their whole set of clock fractions) is the winner. They must reach 6 hours exactly, without going over even if this means missing turns until they get the right numbers at the end.

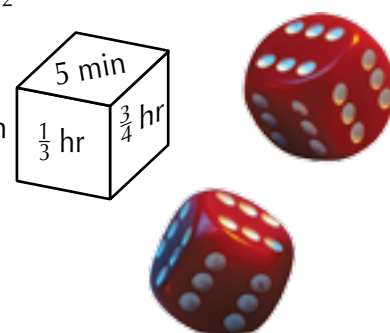

### Division game with clock fractions

Use any small flat object, e.g. a pebble, a bean, an eraser and mark one side with a koki.

Players take turns being the dealer. The dealer decides on an amount of time that all players must put into the 'kitty', e.g. they each put 20 minutes into the kitty. Each player must guess 'marked' or 'unmarked' and the dealer then flips the marked object. If it lands with the marked side up, those who guessed 'marked' are winners. If it lands with the unmarked side up, those who guessed 'unmarked' are winners. The dealer must then deal out the kitty fairly to all the winners, making exchanges where necessary to make the distribution as complete as possible, e.g. he may need to exchange a half hour fraction with 3 ten minute fractions. All players, both winners and losers, must check to see if the sharing is done correctly. If a player finds an error, the dealer must pay a penalty of 15 minutes to the first player to find the error. Then the next player becomes the dealer.

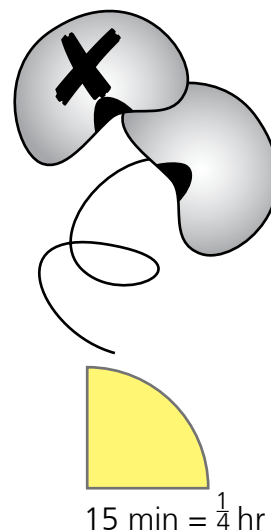

You can choose the amount to put in by spinning to find a time and then multiplying it by the number rolled on an ordinary die, as in the multiplication game.

**Note:** When you are teaching digital time, you can adapt most of these time activities. Make sure that learners understand that you simply add 12 hours to any of the 'p.m.' times used in analogue time in order to find the digital or 24-hour time. Learners need practice reading and writing digital time. For example, 7.30 p.m. is 19:30 in digital time.

## Skills and knowledge

### The learner:

- Identifies important dates on calendars including dates of:
  - a) religious festivals;
  - b) historical events.
- Recognises and describes different calendars used in different cultures.

## Suggested activities

All calendars are based on the movement of the sun, moon and stars.

### Time follows the sun and the moon

#### The sun, the earth and the moon

Calendars are based on astronomy:

- the rotation of the earth each day that makes it appear that the sun rises and sets;
- the revolution of the moon around the earth that causes the moon to appear to change its shape, as it goes through a complete cycle of phases every  $29\frac{1}{2}$  days;
- the revolution of the earth around the sun each year that results in the seasons.

Learners should already have a good sense of the daily path of the sun in the sky and its relation to the earth's rotation from Grade 1, and of the behaviour and cause of the phases of the moon from Grade 2. If you find they don't understand these phenomena, review those activities from the earlier grades.

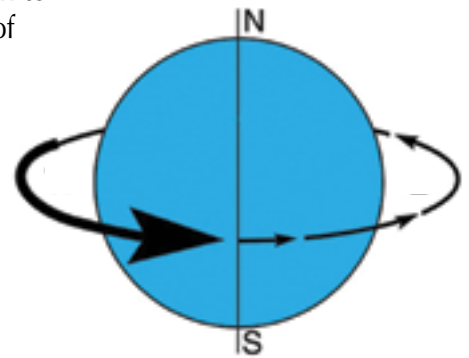

Once learners understand the day and the moon's phases, you can help them to understand the year. The changing seasons show themselves in many different ways. The weather changes, animals migrate or mate and give birth, we celebrate holidays. All of these cycles are the result of the earth revolving around the sun while the earth rotates daily on an axis that is tilted compared to the plane in which it is moving around the sun.

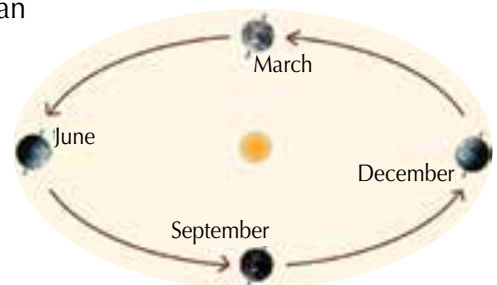

These two motions cause the daily path of the sun to be different during different times of the year, and they cause the stars to move along paths at night in such a way that we see different stars at different times of the year.

#### Expanded opportunity: Finding constellations

Show the children how to find the constellations for the season you are in. At home, have them observe a constellation as soon as it is dark enough to find it. They should draw a picture as well as describe where they see it in the sky. They should observe it again, after an hour, again drawing a picture and describing what they see. They should make periodic observations until they have to go to bed, and if they get up before sunrise they should look again to see if they can find it. Have them observe the motion of their constellation every night for a week. Then lead a discussion about what they have observed.

See Resources,  
p383

This activity is more difficult in the summer when the nights are short. Still, it is good to do it at the beginning of the school year, then repeat it in the middle of the year, and again at the end of the year, so that learners get a sense of how the stars change their apparent positions during the year.

## Grade 3: Measurement

### Calendar questions

Each of these activities should be done, in order, on different days. For these activities use a process where each learner has a few minutes to think about the question alone, then he or she discusses the question with a partner.

Then the partners discuss the question with their group and finally all of the groups share their responses. You can create a list of their responses or have the learners create a graphic display of their collective response.

#### How do you use the calendar at school and at home?

Be sure that all the learners are aware that their own lives are organised into days, weeks, months and years, and that the calendar is the tool we use to agree on when we should go to school, have a holiday, celebrate birthdays and attend ceremonies.

#### What other ways do people use a calendar?

Be sure that the responses include subsistence needs like when to plant, (which means predicting when it will rain), as well as cultural and religious questions, such as holidays, when to go to work, scheduling the World Cup, when to go to vote, etc.

#### From nature or society?

Our calendar counts days, weeks, months and years. Which calendars come from nature?, e.g. a lunar calendar follows the cycles of the moon. Explain in words or pictures. Which ones come from society?

The day corresponds to the rotation of the earth on its axis which takes 24 hours, and the year corresponds to the annual revolution of the earth around the sun which takes  $365\frac{1}{4}$  days. Because the year is not an exact multiple of the length of the day, there is a little bit left over each year, about  $\frac{1}{4}$  day.

Ask the learners what we can do with the extra part of a day. There is about  $\frac{1}{4}$  day extra each year, so after four years there's  $\frac{4}{4}$  extra, so we can add one extra day every fourth year, which is called a leap day. Each leap year, each 4th year, has an extra day - February 29.

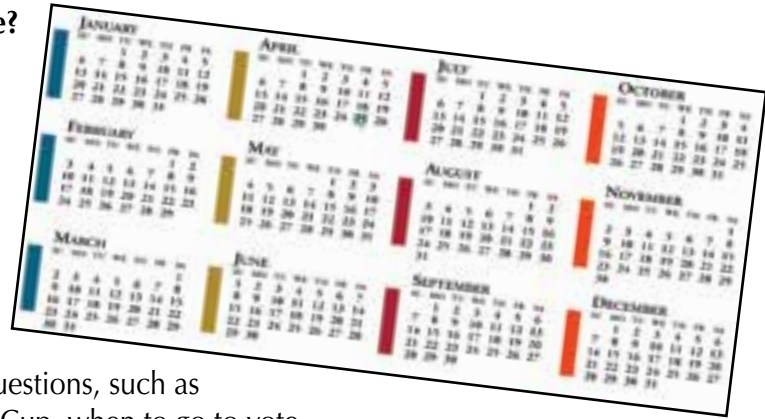

#### The month

Explain that the word month means moon, and months used to be the actual period of the moon's phases – about  $29\frac{1}{2}$  days. They still are in some other calendars we will learn about, but months in our modern Western calendar are no longer the same as the moon's cycle and our calendar no longer keeps track of the moon's phases.

#### The week

The week seems to have no connection to astronomy and to be purely cultural. Wherever there is civilization people need to meet periodically to exchange goods, to visit, and often for worship, to entertainment, or for activities of government. Every society adopts a regular period between market days, some are as short as 4 days apart and others are as long as 10 days between. The ancient Hebrews in Israel held their markets every 7<sup>th</sup> day. Their 7-day week is reflected in the creation story that says that God created the world in six days, and rested on the 7<sup>th</sup>. The Christian calendar adopted the 7-day week from the Hebrew calendar and now the 7-day week is used around the world.

**Why did people who lived long ago need a calendar?**

The learners should be able to identify needs similar to those for which we use the calendar today, (early farmers needed to predict when the rains would come, in order to know when to plant, and when to hold meetings and religious festivals).

Traditional tribal people who live by hunting and gathering need to know when to travel to specific places to collect plant or animal food. In Africa, like the rest of the world, people long ago noticed that certain stars appeared in the sky just before important events, such as the coming of the rains.

Use the Resource Section ([See Resources, p382](#)) to choose some stories to share, or tell others you may know. Ask learners to ask family members if they know stories about the sky, or know how their ancestors used stars in hunting, farming or navigating.

**Expanded opportunity: The race between the sun and the moon**

Ask learners to think about what would be the best possible calendar.

The moon's phases don't fit equally into the year, so you can't have a calendar that keeps track of the year with an even number of moon cycles. Would they just rely on the sun and not try to make the calendar keep time of the moon's phases? Would they follow the moon only and not try to make the calendar keep time with the seasons? Or would they try to find a way to keep track of both?

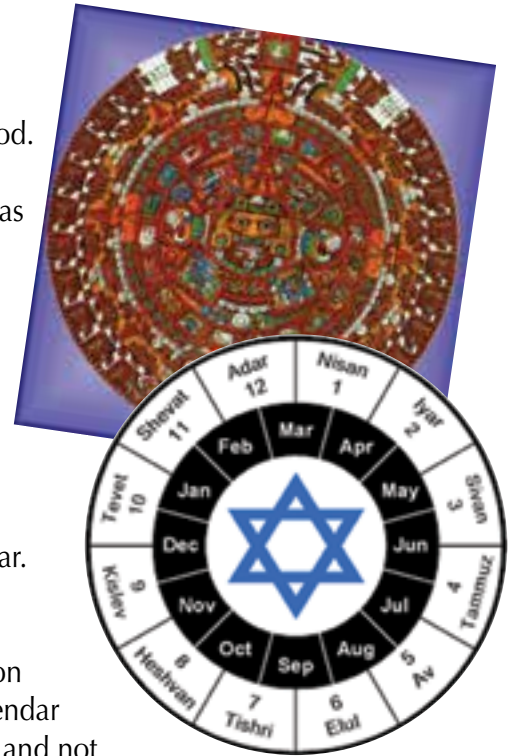
**Different calendars**

The Western calendar that is used internationally today is the Christian Calendar that was developed a long time ago by Pope Gregory - so we call it the Gregorian Calendar. It only keeps track of the sun and not of the moon. It has 365 days, except when an extra day is added for leap years. The length of the months was not decided by nature, but by politics. In ancient Roman times the months were named for important people who wanted more days in their months than the other important people. Most Christian holidays occur on the same date every year. The exception to this is Easter, and the holidays associated with it like Good Friday and Lent. The first Good Friday happened on the Jewish Holiday of Passover, whose date was, and is, set according to the moon. So Christians today use the moon, as well as the week and the season, to decide what day to celebrate Easter.

The Muslim calendar only keeps track of the moon and not of the seasons. It has 12 months which are about  $29\frac{1}{2}$  days on average. The true length of the month is a little longer some times and shorter other times. The length of each month depends upon when the new moon is actually visible, not on an average, so it is very closely tied to nature. The year has 12 months of  $29\frac{1}{2}$  days, or 354 days, so it is about 11 days shorter than the Western calendar.

The Hindu, Jewish and Chinese calendars do both. They follow the phases of the moon for 12 cycles, so they get a little behind the seasons and the Western calendar each year. Unlike the Muslim calendar, though they add in a leap month from time to time so that festivals stay in the same season from year to year. The rules are different for each lunisolar calendar, but they all require a leap month every second or third year.



## Grade 3: Measurement

### Projects about time

#### How long until our holiday?

The table below shows the dates of some of the holidays celebrated by communities in South Africa. The dates for the holidays are calculated using a variety of calendars, but all the dates shown are in our common Gregorian Calendar. Have learners work in groups. The task is first to find the actual number of days from the celebration one year to the same holiday the next, for example, there are 385 days between Easter 2008 and Easter 2009, and there are 365 days between Christmas 2008 and Christmas 2009. When will the time from one Christmas to the next NOT be equal to 365 days? After they have filled in the table as a group they should look for patterns. What certain numbers occur frequently? Do they have any ideas why?

	2008	2009	2008 to 2009	2010	2009 to 2010
<b>Islamic Calendar</b>					
Ramadan Begins	2-Sep-2008	22-Aug-2009		12-Aug-2010	
Eid-ul-Fitr	1-Oct-2008	21-Sep-2009		10-Sep-2010	
<b>Hindu Calendar</b>					
Diwali	28-Oct-2008	17-Oct-2009		5-Nov-2010	
Holi	21-Mar-2008	11-Mar-2009		1-Mar-2010	
<b>Chinese Calendar</b>					
Chinese New Year	7-Feb-2008	26-Jan-2009		14 Feb-2010	
<b>Jewish Calendar</b>					
Rosh Hashanah	30-Sep-2008	19-Sep-2009		9-Sep-2010	
Yom Kippur	9-Oct-2008	28-Sep-2009		18-Sep-2010	
<b>Christian Calendar (which is also the common Calendar)</b>					
Easter	23-Mar-2008	12-Apr-2009	385	4-Apr-2010	
Christmas	25-Dec-2008	25-Dec-2009	365	25-Dec-2010	

#### Names of the months

While Xhosa has modern names for the months, based on the European names, the old names say a lot more about local life and nature during the year. Have learners work in groups to research the origins and meaning of other month names – either from the names used in other local languages, or the months of one of the calendars in the above table. Have each group present their findings to the class.

- January – *eyoMqungu* (month of the Tambuki Grass)
- February – *eyoMdumba* (month of the swelling grain)
- March – *eyoKwindla* (month of the first fruits)
- April – *uTshazimpuzi* (month of the withering pumpkins)
- May – *uCanzibe* (month of Canopus)
- June - *isiLimela* (month of the Pleiades)
- July – *eyeKhala* / *eyeNtlaba* (month of the aloes)
- August – *eyeThupha* (month of the buds)
- September – *eyoMsintsi* (month of the coast coral tree)
- October – *eyeDwarha* (month of the tall yellow daisies)
- November – *eyeNkanga* (month of the small yellow daisies)
- December *eyoMnga* (month of the mimosa thorn tree)

Learners could also investigate the origin and meaning of the names of the days of the week in different cultures.

## Skills and knowledge

### The learner:

- Estimates, measures, compares and orders three-dimensional objects using non-standard and standard measures:
  - a) mass (e.g. packets, kilograms);
  - b) capacity (e.g. bottles, litres);
  - c) length (e.g. desk lengths, metres).

## Suggested activities

### Comparing rocks

This series of activities helps learners develop an integrated experience of mass, capacity, length and area. Ask learners to collect empty 2-litre bottles and each bring a small rock to school.

### Which rock is bigger?

Brainstorm with the learners about all the attributes of their rocks. Which attributes are measurable?

Ask the learners, "When someone says this rock is bigger than that one, what do they mean?" Brainstorm possible meanings of 'bigger' when comparing two rocks.

Be sure the learners know that bigger doesn't mean better and that they are not competing to have the biggest rock. They are working together to discover how to decide which rock is bigger.

### Which rock has the most mass?

Each group of learners needs a two arm balance.

To make the balance cut the tops off two cold drink bottles about  $\frac{1}{3}$  of the way from the bottom of the bottle. Try to make them exactly the same height. Punch three equidistant holes around the rim of each bottle. Cut six lengths of string, about 50 cm each and tie one string through each hole. Gather the 3 strings together in a knot, being sure they are the same length so that the bottle will hang straight. Do the same with the other bottle, making sure the strings are the same length for both bottles. Attach one bottle to each arm of the balance. Adjust until the empty bottles balance. Before glueing the string in place, test your balance with two light objects you know to have identical weight. If it's not perfectly balanced, either move the bottle that hangs too low in a little toward the centre, or move the bottle that is too high out from the centre. Once it's balanced, glue the strings in place and the balance is ready to be used. Have each group of learners order their rocks from lightest to heaviest using the balance, and explain how they determined the order.

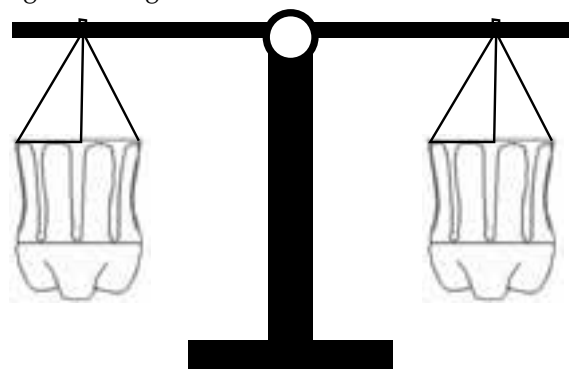



## Grade 3: Measurement

### Which rock has the greatest surface area?

Give each learner a sheet of grid paper. (See Resources, p360) Have each learner estimate the surface area of their rock. They must say how many grid squares they think they will need to cover their rock completely - with no gaps and no overlap.

Distribute aluminum foil. Each learner should carefully cover the rock with aluminum foil, being sure not to overlap or leave any gaps. They then spread out the foil onto the grid paper and trace its outline. Guide learners as follows:

Help learners to calculate how many squares their piece of foil covered by instructing them to, "First, count all the squares that are completely inside your outline.

Next, look at the squares that are partly inside and partly outside the outline. Estimate the number of whole squares they make. If a square is about half inside, look for another square that is about half inside. Together they make up one whole square. If a square is almost all inside the line, look for one that is only a little inside. Together they make up one whole square. What is the surface area of the rock that you measured? How does it compare to your estimate?"

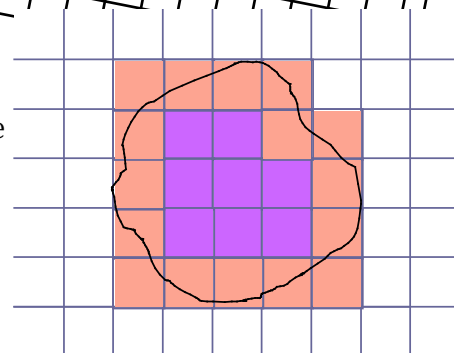
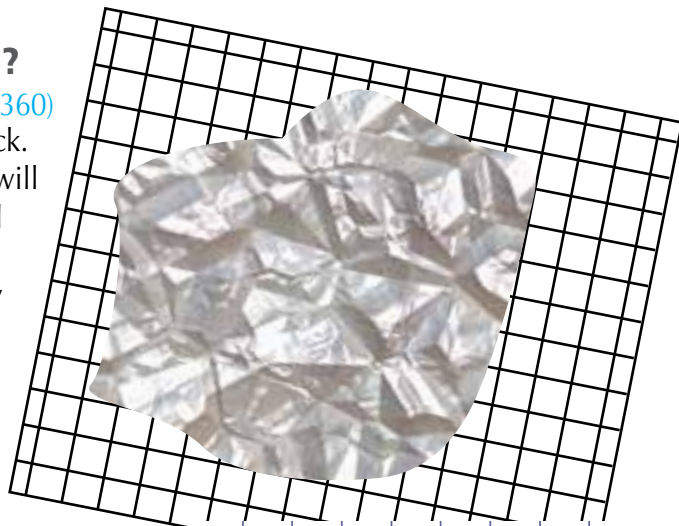

### Which rock takes up the most space?

Tell or read the story of Archimedes in the Resource Section.

(See Resources, p385)

Read about a discovery he made while lying in the bath.

Have each learner estimate the volume of the rock – that is, how much space does it take up. They should make an estimate in millilitres, and write down their estimate.

After recording the estimate, each learner must find a container large enough for their rock to fit completely inside, without sticking out at the top. They will then place the container inside a larger container and carefully fill their small container to the very top without spilling over. Then they gently lower their rock, tied with a piece of string, into the smaller container, letting the extra water flow into the larger container.

Guide learners as follows:

"Is the rock completely covered by the water? If not, adjust it so that it is. Does the water still come completely to the top of the smaller container? If not, spoon water from the larger container into the smaller container until the water reaches the top."

They then carefully remove the smaller container with the rock, without spilling. They might need a third container to catch any splashes. They then pour the water from the larger container into a measuring cup. Lead a class discussion to help learners understand that, as Archimedes realised, the water that was 'displaced' (pushed out of the small container) by their rock gives the volume of their rock.

Also discuss how their measurement of the volume compares with their estimate?

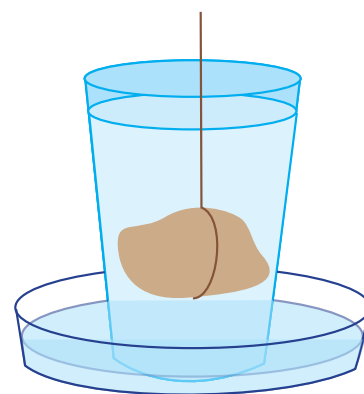

### Which rock is longest? Or widest?

Ask the learners to think about how they would compare their rocks in terms of length. Is the longest one the biggest? Or do they also have to consider the breadth? What are different ways they could use length to order their rocks?

Close the rock measurement session by returning to the question of what we mean when we say that one rock is bigger than another. What does the question mean to them now? Which measurements might matter and which do not?

### More activities for mass, capacity, length and area

- Investigate a variety of 3-D objects. Estimate their mass, length, surface area and volume and use the same methods used to investigate the rock to measure each quantity.
- Estimate the capacity of a variety of containers. Then fill them with water or something else pourable, like rice, and pour the water or rice into a measuring cup to find the containers' volumes in millilitres or litres.
- Estimate the mass of a number of objects by lifting them, and comparing how heavy they feel to things of known mass, e.g. 2 kg of sugar, 500 g of margarine. Then use a scale to measure the mass in grams or kilograms.

## Skills and knowledge

### The learner:

- Investigates (alone and/or as a member of a group or team) and approximates:
  - a) distance around two-dimensional shapes using string;
  - b) area of two-dimensional shapes using tiling.

## Suggested activities

### Measuring length and perimeter

#### String measurements

- Have learners estimate the distance around 3-D objects, then measure them with a string, then measure the string with a ruler. Use both regular shapes, such as a box, and irregular shapes, such as their hand or foot.
- Have learners estimate and then measure large objects and small objects, things with straight sides and things with curved sides.
- Have learners estimate the length of lines and curves, then measure with a string, then measure the string with a ruler.

You can use copies of the worksheet on page 381.

#### Visual puzzles

In order to develop an understanding of length it is not sufficient for learners to merely measure repeatedly. Rather they need to be presented with situations which require them to think about what they know and how they know it. Give them visual puzzles like these. Use the **Circle Lab** activity in Data Handling for measuring circles.

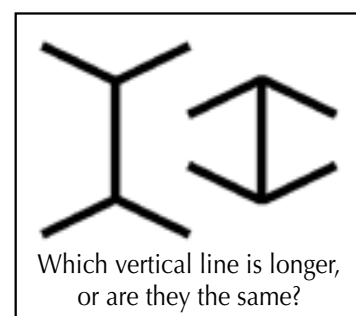
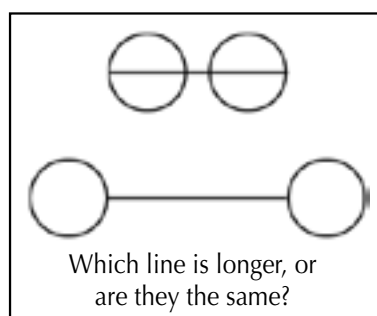

## Grade 3: Measurement

### Make your own metre tape measure

How big is a centimetre? Give each learner some centimetre grid paper. Ask them to look around the class and find as many things as they can that are about 1 cm in length.

They are going to cut the centimetre grid paper into strips and connect the strips with sellotape.

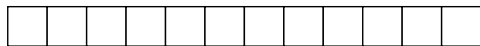

How big is a decimetre? What things can the learners find that are about 10 centimetres, or 1 decimetre, in length?



Learners should colour strips that are 1 cm wide and 10 cm long. They connect 10 differently coloured decimetre strips together to make a tape 1 metre long.

How high is a metre? Have learners work in pairs and use their metre tape measure to find a point on their body that is 1 metre high. With their arms outstretched, measuring from the tips of their fingers, where along their arms is 1 metre from their finger tips?

### Measuring area

#### Measuring area with squares

Learners work in pairs. They need plastic, paper or cardboard squares.

Introduce this activity by saying that we can use small squares to make larger squares – show one small square, and another square made up of four squares. Ask the class what the next larger square is.

Ask a learner to build a 3 x 3 square at the board. Ask the class how many small squares they used altogether to make this new square.

And then ask what the next larger square will be. Make the next square or have a learner make it, and again ask them how many squares it contains. Each square is a different size but they are all the same shape - square. Figures that are the same shape but different sizes are called *similar*.

#### Measuring area with triangles

Is it possible to make figures from triangle shapes that are *similar* to the original shape (a different size but the same shape).

Ask the learners if they can put some triangles together to make another bigger triangle. It must be made of triangles that touch with no gaps and no overlaps. The larger triangle must be exactly the same shape as the small one. Do not show them the answer – let them explore and develop their spatial visualization skills. Ask them how many smaller triangles make up the next larger triangle (4). Have them make the next two larger triangles and ask how many smaller triangles are in them. (9 and 16)

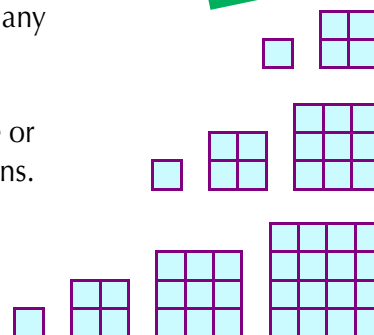
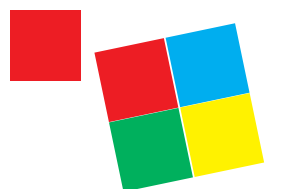

similar

### Measuring area with other shapes

Have them try the same with the parallelogram and the trapezium. They will find the same pattern of 1, 4, 9, 16. It's sufficient at this stage for them to discover the pattern. It's not necessary for them to be able to explain it. If some learners ask you for an explanation, guide them with questions to explore possible explanations. You can start by asking them to predict how many pieces will be needed for each larger shape.

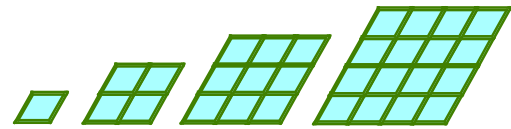

Hexagons do not fit together to form larger hexagons, but if you have some learners who need a special challenge you can ask them to make larger hexagons from a variety of shapes. They can then investigate the relationship of the area of the larger hexagon to the first smaller hexagon.

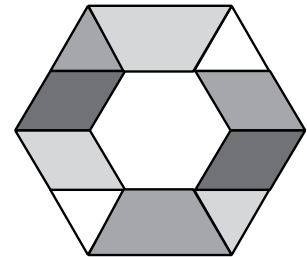

### Finding more areas

For each group or pair of learners, prepare cut-outs of the hexagons, triangles, trapeziums and parallelograms from the resource page Fractions of the hexagon. (See Resources, p358)

Tell learners that, for this activity, they will use the triangle as their unit for measuring area. Let them experiment to find out how many triangles they need to cover each of the three other shapes. They must record their findings on a table like this:

Then ask them to combine the shapes in as many different ways as they can to make hexagons. For example:

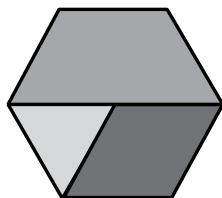

Learners must trace each hexagon they make and write a number sentence, using triangles as their units, to show the area of each hexagon. So, for the hexagon above, in any order, they should write:

$$3 + 2 + 1 = 6$$

(3 triangles to make the trapezium, 2 for the parallelogram plus 1 more triangle)

Other ways to form a hexagon include: using 6 triangles



(1 + 1 + 1 + 1 + 1 + 1) or 2 triangles and 2 trapeziums (1 + 1 + 2 + 2).

When learners share their findings in a whole class discussion, be sure that they notice that when different learners used the same pattern the number sentence was sometimes written in a different order. They should also observe that there are many different patterns with the same area.

Assess the learners' understanding by asking them to find the area, in units of the triangle, of a variety of figures you make. If some learners need an extended challenge, have them find areas in units of the parallelogram, trapezium or hexagon.

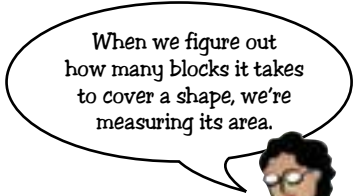
Integrates with  
Maths LO1 AS10a)

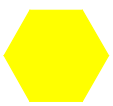

Shape	Area in units of triangles
	
	
	
	

# Grade 3: Measurement

## Tangram Areas

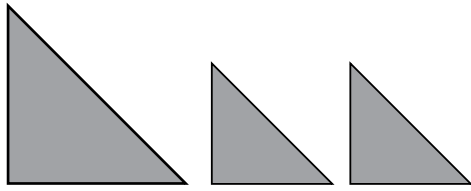

Use the two small triangles and one medium triangle from a tangram set to make polygons.

Make cardboard copies of the Tangram pieces, Resources, p374, for learners to cut out.

Using all three pieces for each shape, build each of the polygons below. Trace each polygon onto your paper.



Ask the learners which polygon has the greatest area. Discuss their thinking with them.

Prepare drawings of this square for pairs or groups of learners to work from. Also let them copy the tangram table below. Working with all the tangram shapes, have the learners use a small tangram triangle as the unit of area.

- What is the area, in small triangles, of each of the other tangram pieces?
- What is the area of the whole square? (16 small triangles)

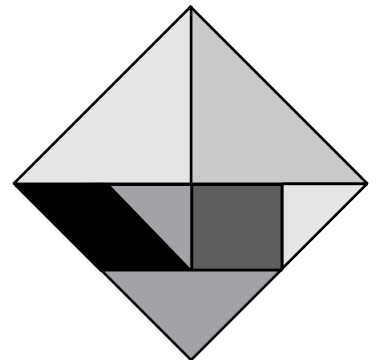

Let the learners invent tangram pictures and have other learners find the area of those pictures in units of small triangles or in units of the other tangram pieces.

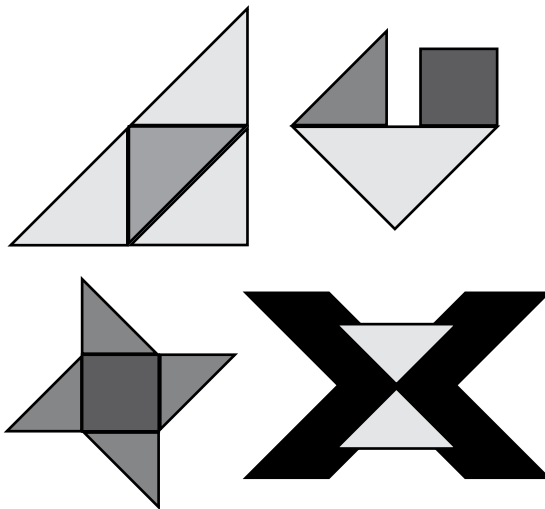

Tangram shape	Area in units of the small tangram triangle

## Puzzles involving area

Give learners challenging puzzles involving area that require them to think about what they know and how they know it. For example:

You can make copies of the worksheet in Resources, p381.

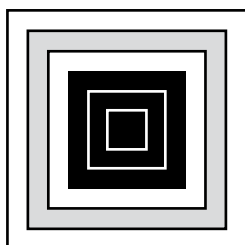

Is there more grey or more black in the picture, or do they have the same area?

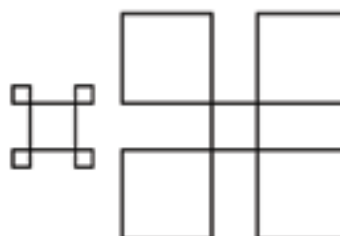

Which of the two inside squares in these 2 drawings is bigger, or are they the same size?

Lead a general discussion about measuring area. Ask learners to brainstorm as many ideas as they can about what they have learnt about measuring area. They should realise that we can use various shapes as our units of measurement. Tell them that people decided to use square shapes as the most common unit of measurement.

### Vocabulary

#### Time:

early	late	day	night	morning	afternoon
evening	before	after	beginning	end	clock
watch	face	hand	later	earlier	sunrise
sunset	shadow	o'clock	clockwise	anti-clockwise	half past
quarter past	quarter to	minutes past	minutes to	fast	slow
today	tomorrow	yesterday	names of days of the week and months of the year.		

#### Mass:

heavy	light	heavier	lighter	heaviest	lightest
heavier than	lighter than	more/less	same as	has greater mass	has less mass.

a light object has less mass  
a heavy object has more mass

#### Capacity:

full	empty	holds more than	holds less than	half full
the same as	least	most	cups	buckets
jugs glasses	estimate	container.		

#### Length:

longer	shorter	taller	higher	as long as	as short as
estimate	high	low	shallow	hand span	foot
pace	centimeter	metre	millimetre.		

### Resources

clock faces without numbers	bags
spinners	feathers
special dice	rocks
grid paper	a scale or balance
scissors	objects for casting shadows
sellotape	torch
aluminum foil	table
water	lamp
sand	pictures relating to time of day
containers of various sizes	pictures relating to holidays of different cultures
beans to plant	picture of the earth from space
plastic or cardboard shapes	constellation maps and star finders
tangrams	information on Islamic, Hindu, Jewish, Chinese calendars
string	holiday dates, timetables, newspapers,
rulers	information on the times of historical events,
blocks or other material to stack and build with	times from local or school sports.
boxes	



The learner will be able to collect, summarise, display and critically analyse data in order to draw conclusions and make predictions, and to interpret and determine chance variation.

## Skills and knowledge

### The learner:

- Collects data (alone and/or as a member of a group or team) in the classroom and school environment to answer questions posed by the teacher (e.g. “How many learners walk to school?”).
- Sorts, orders and organises own and supplied data by one or more attributes for a particular reason.
- Draws pictures and constructs pictographs and bar graphs that have a 1-1 correspondence between own data and representations.
- Reads, interprets and reports on information in own and a peer’s representations of data.
- Reads and interprets data presented in simple tables and lists.

The vocabulary that learners need to understand and use for these skills is listed at the end of the suggested activities. You will find it helpful to make flash cards with key vocabulary words to support the teaching and learning process. A list of the resources you will need for the activities are also provided.

## Summary of the types of graphs used in Grade 3

### Lists

A list is a series of related words, numbers, or other items. We use lists every day - a grocery list, a list of errands, letters to write or calls to make. A list may or may not be numbered, or organised in some logical way, and it may or may not be displayed with lines, rows, columns, etc. You could ask each learner how he or she got to school today, and make a list of the answers as you receive them.

#### List of ways we get to school

Mpho comes by car.  
Lerato takes the bus.  
Nonhlanhla rides her bike.  
Kelebogile takes a taxi.  
Thabo comes by car,  
Khaya rides her bike.  
Liziwe takes the bus.

### Sorting circles (Venn diagrams)

When children begin to sort objects, they group the objects together, and may make a line around each group with crayon or with string, or make pictures of the objects in groups, and encircle the groups that belong together. Sometimes we give them the attribute they should sort by, and other times they choose it themselves. Although the learners sort groups of objects with many attributes, in the early grades the learners sort on only one attribute at a time, and the sets do not overlap (intersect).

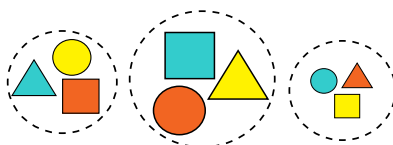

First we sorted the shapes by size. We put the big ones together in one group and the small ones in another. The middle sized shapes made a third group.

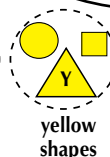
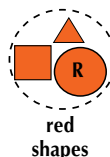
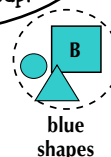

We put blue shapes in one group and red shapes in a group and yellow shapes in a group. We sorted the shapes by colour.



At about Grade 3 level, learners are ready to sort using two (or more) criteria simultaneously. When they do, it is possible that the sets may overlap. A tomato is a fruit (the part of the plant that contains the seeds) and it is also a vegetable.

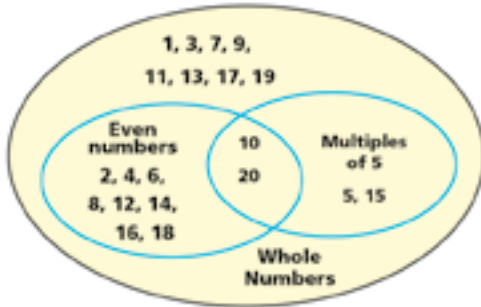
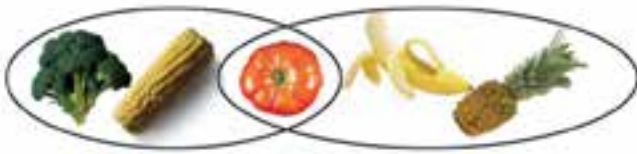

From Grade 3 onward, this kind of diagram is very helpful for understanding the relationships.

Here are 3 sets - squares, blue things and big things. They overlap because the big blue square is inside all 3 sets.

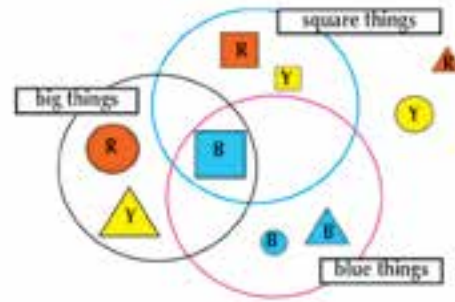

### Concrete object graph

A concrete object graph involves categories and counts of the number of people or things in a category (frequency). **Actual people or things** are placed on the floor, desk, or paper to display the categories and counts. The layout of the graph can be in any direction. The layout here is horizontal.

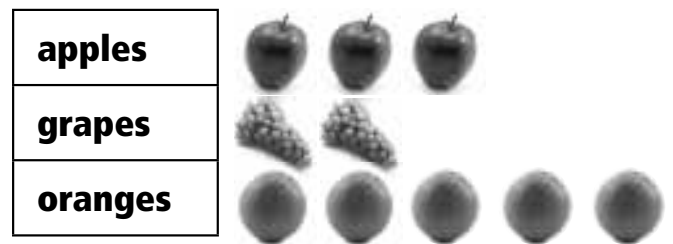

### Pictograph or pictorial graph

A pictograph or pictorial graph involves categories and counts of the number of people or things in a category (frequency). **Drawings or other pictures** are used to display the counts in each category. The layout of the graph can be horizontal or vertical. The layout here is horizontal.

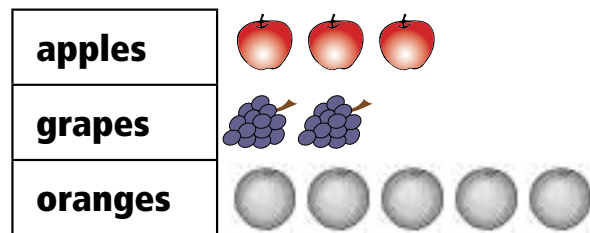

### Symbolic graphs and tallies

A symbolic graph uses some type of symbol (a tick mark, an X, a happy face) to display the count in each category. The layout of the graph can be horizontal or vertical. The layout here is vertical.

When you use tally marks grouped by 5, the symbolic chart used is called a tally chart.

Ways we get to school

Car	///
Bus	////
Walk	////
Bike	///
Taxi	

	□	
	□	
□	□	□
□	□	□
<b>Kokis</b>	<b>Pencils</b>	<b>Pens</b>

## Grade 3: Data handling

### Bar graph

A bar graph involves categories and counts of the number of people or things in a category (frequency). A bar is used to display the count in each category. The layout of the graph can be horizontal or vertical. The layout here is vertical.

The bars are separated from each other to indicate that the categories are discrete (non-continuous).

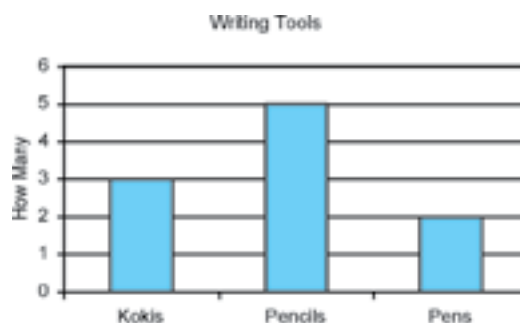

### Carroll diagram

Carroll diagrams are rectangular tables that display data in a yes/no way. They are named in honour of Lewis Carroll, the author of *Alice in Wonderland*, who was also a mathematician.

Suppose, for example you have the numbers 1, 2, 3, 4, 5, 6, 7 and you ask if each number is even. The Carroll diagram would look like this.

Even	Not Even
2, 4, 6	1, 3, 5, 7

### Carroll diagram with 2 criteria.

When learners begin to analyse sets using two or more criteria (starting in Grade 3) you can use more complex Carroll diagrams. Here's an example of one with 2 criteria. You have the integers from 1 to 20 and you want to know which are even, and which are multiples of 5.

	Even	Not Even
Multiple of 5	10, 20	5, 15
Not a multiple of 5	2, 4, 6, 8, 12, 14, 16, 18	1, 3, 7, 9, 11, 13, 17, 19

### Tables

If you have a lot of data in a list that isn't organised, it's not easy to summarise it at a glance. Often you can see patterns in the data more easily if, as you collect the information, you record it in a table.

A table has rows and columns for the information. The grid lines may or may not be displayed. Spreadsheets used in computing are examples of tables.

If you know that all the learners travel to school either by bus, car, bicycle, walking, or taxi, you can make a table with the means of transport across the top. Then, when you learn how a particular learner arrived that day, you can record his or her name in the right column. This is a good way to record the data if you want to know not only how many learners arrived by each method, but also who came to school with which transport.

Ways We Get to School

Car	Bus	Walk	Bike	Taxi
Mpho	Lerato	Paul	Karabo	David
Thabo	Lesedi	William	Nonhlanhla	Steven
Mary	Liziwe	Ngubo	Khaya	Kelebogile
	Elsie	Queenie		Zami
	Manare			Luna
				Heather
				Ayanda

Tables are often used to record data when conducting experiments.

**Suggested activities**

**Examples of data that learners could collect**

- Kinds of footwear children like
- How much different family members weigh
- Different lengths of clothes, e.g. scarf, pants, socks, etc.
- Cleaning materials used at home
- Time spent watching TV
- Objects that can float/sink
- What objects are made of, e.g. wood, glass, plastic, etc.
- Favourite colours/ toothpaste/ soap/ fruit/ vegetables/ etc
- Ages of family members
- Ages of learners in the class
- Farm animals, wild animals, pets
- Ways of transport to school
- Birthdays of learners / family
- Different kinds of homes
- Toys learners have
- Reading lists of learners
- Learners who walk to school
- How much pocket money learners get in a month
- Weight of products
- Animals, e.g. pets or wild animals
- Examples of items that could be listed
- Favourite ball games
- Birthday guests
- Things to do during the day
- Sport activities

- Weather chart: how many sunny/ windy/rainy days; temperatures, etc.
- Favourite food, fruit or sweets
- Names of family members
- Names of classmates
- Healthy or unhealthy food
- Forms of transport
- Shopping list
- Things to pack for holiday

Pages per week	John	Lee	Mpho	Thabo
45				✓
40				✓
35	X			✓
30	X		+	✓
25	X		+	✓
20	X	■	+	✓
15	X	■	+	✓
10	X	■	+	✓
5	X	■	+	✓

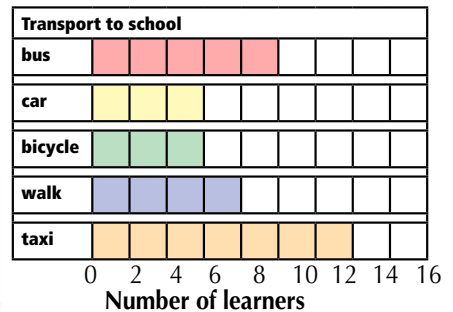
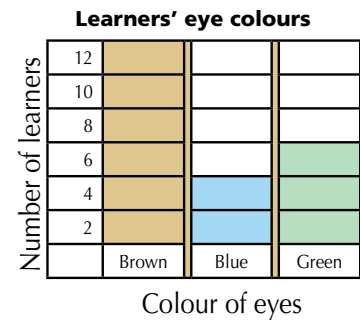
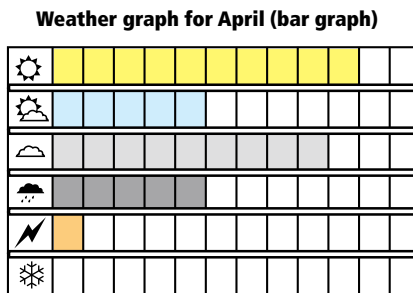

**1. Animal Exploration**

Here is an example of an integrated exploration where learners use data processes, language, art, science and maths skills in a unit of study on animals.

**Activity 1: Animals around us**

Ask learners to think about all the animals they have ever seen or might see. Learners may have different ideas of what we mean by 'animal'. Invite them to include all the animals they might see – pets, farm animals, wild animals, pests, birds, mammals, amphibians, reptiles, insects, spiders, fish. After they have brainstormed many different animals, have each child choose one animal to study. Make available any resources you can collect – books, encyclopedias, magazine articles, etc. Also encourage them to conduct their research by interviewing adults in the community. They will prepare a report on what they learn.



## Grade 3: Data handling

### Activity 2: Describing our research

Facilitate the children in a brainstorm about the kind of information they would like to know about these animals. Their list might include:

- What is it called?
- Where does it live?
- What does it eat?
- Is it dangerous?
- Is it good to eat?
- How big is it?
- What does it look like?

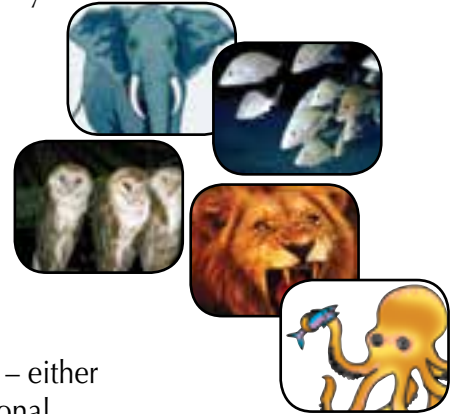

Encourage the learners to collect and share stories about the animals – either personal experiences that they learn about from interviews, or traditional stories about the animals. Discuss the report with each child, clarify any areas necessary, and allow them time to revise their written work.

Each learner should prepare a card with a picture of the animal he or she is studying. Be sure the pictures are on cards that are all the same size.

### Activity 3: Reporting and sorting

Invite each learner to share his or her findings with the class. This could take place over more than one day. As they do so, have them put their picture card of the animal on the board. When all children have reported, brainstorm what makes some animals alike or different from others – how can they sort all the animals into categories?

Once they have decided on the categories, write them in a column to the left of the board. Have each child put his or her animal next to the name of the appropriate category, forming a horizontal pictograph.

Ask them for their thoughts on the graph. You can cut out cartoon balloons from paper and write some of their comments on them.

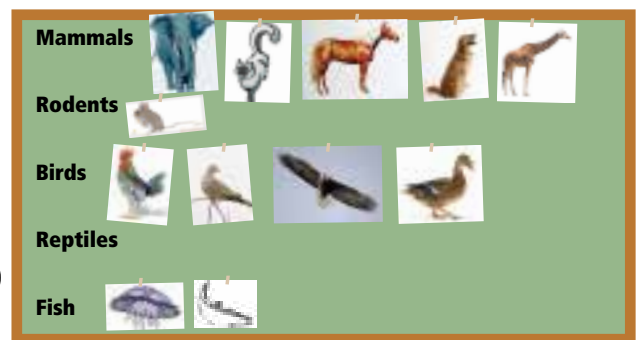

strip to measure 'fish' category

### Activity 4: Animals in a circle

Start with the top row (mammals). Stretch long strips (made by taping together strips of any paper) along the length of the animal pictures for that row. Mark the beginning and end of the row on the paper strip, cut it to length, and label it with the category, such as 'Mammals'. Then do the same with each of the other category rows.

Tape the five strips together and form them into a circle. Gather the children around and spread out the circle on the floor. Mark the centre with a weight, such as a rock or a cup. Have a child help you stretch a string from the centre to the point on the paper tape circle where the sections meet. Label each section with the animal category. Have each learner take his or her animal from the graph and put it into the appropriate category in the animal circle.

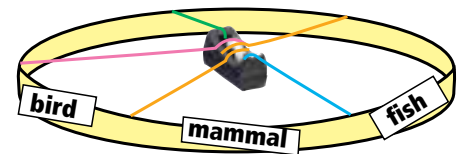

Animals we saw this week

Rat	Cat	Dog	Bird



### Activity 5: Field research

Assign learners to the task of observing and recording every animal they see during the course of a week. Be specific about what information they should collect and how they will record it.

### Activity 6: Graphing the group's observations

Have the learners work in groups and combine their real-world data about animals. Each group should make a bar graph for their collective data.

When you introduce bar graphs, give learners rows or columns made up of boxes of equal size. The rows or columns should be separate from each other, not touching. Have the learner colour in one box for each data point, such as each time they saw a particular animal.

Encourage learners to title their charts by asking questions about the graph. Try to keep the focus on the actual content, and help them to convey it more clearly. The abstract rules for graphing (rules about scale, axes etc) are not necessary at this level. What is it that they want to say with this graph?

Does it communicate what they want to say?

Display all the graphs and let the learners talk about the differences between the data from different groups.



### Activity 7: Individual learners' graphs of their observations

Working with his or her own data for the week, each learner should decide how to group it into categories, and explain the reason why. The learners then make bar graphs of their own animal observations.

#### Variations and extensions

You can do similar related activities observing plants instead of animals, or with a smaller category like trees instead of all plants, or with any number of collections of objects in nature or in the culture of the place where the learners live.

## 2. Rubbish!

Learners work in groups. During the course of a week ask learners to save things they would normally throw away. They can bring things from home as well as save things from the classroom and school grounds.

Have each group pick ten items from their rubbish collection. Discuss what kinds of materials the learners have selected and agree on the categories to use for sorting. There will probably be a category for paper and another for plastic. Are there any other categories with quite a few items? You might want to suggest a category called 'other'.





### Grade 3: Data handling

Have each group make a chart with these categories and decide which items of rubbish belong in which category.

What kinds of things do we throw away?				
paper	plastic	?	?	other

Display all the graphs so the learners can see all the results together. Ask each group to think about the things that are thrown away. What are some things that could be re-used instead of being thrown away, and how could they be re-used? What are some things that could be recycled – made into something else? Ask groups to report their ideas to the class. If possible, use some of the learners’ ideas for re-using and recycling materials.

### 3. Friendship salad

- Plan this activity in advance so you can ask families for help in collecting the pieces of fruit. Ask each child to bring a piece of fruit to class to share, if possible. Discuss the set of collected fruits. What are some possible ways to classify the fruit? (colour, shape, size, where it grows, most popular). Choose a way to sort the fruit and make a graph.
- Make a salad for the whole class with all the fruit. Where possible, have learners observe the fruit cross-sections. If there are any apples, cut a horizontal slice to show the star pattern. Ask learners to describe what they see.
- Do they see any shapes or patterns? Compare how each fruit looks from the outside to how it looks from the inside. How is it alike and how is it different from these two points of view?
- What symmetries do they observe from outside the fruit? And from inside?
- Eat the salad together.
- Do a quick opinion survey of who liked the fruit salad and who didn’t. Or you could ask different questions such as, “Which fruit in the salad did you like best?” or “Which of these fruits do you eat most often?” etc.
- What if they want to serve twice as many people? Make a table of the ingredients in the double recipe of fruit salad.
- What if they want to make half as much? Make a table showing how much of each fruit will go into half of the recipe of the fruit salad.
- Make a table the whole class can read with the names of all the fruits and the approximate cost. Using a table, have each group find the cost of each ingredient – 1 whole fruit, the cost for the amount of that fruit in their recipe, and the total cost of the whole recipe.



The cost of our friendship fruit salad			
Fruit	Price for one fruit	How many used	Cost for this ingredient
Banana		2 <sup>1</sup> / <sub>2</sub>	
Apple		2	
Watermelon		<sup>1</sup> / <sub>2</sub>	
Mango		1	
<b>Total cost of the fruit salad</b>			

### 4. Calendar activities

Ask each learner to think about a special time of year they enjoy at home. Give them time to think about why they enjoy that time, and to work on a poster to share with the class. Have each child speak for a minute or two about their poster of the time of year they like best.

## 5. How much will you grow this school year?

### Step one: Estimating and measuring

You will need: rulers, string, scissors, lots of equal sized paper squares.

- Hold up a strip of paper exactly 13 cm (or some other length, but a whole number of centimetres). Ask the learners to estimate how many centimetres long the strip of paper is. They must write their estimates in their books, and also on a paper square. Ask one representative of one pair to come to the front of the class and hold up their estimate. Ask the representative of a second pair to come to the front and stand to the right (from the class's point of view) if their estimate is larger, and to the left if it is smaller. Ask the rest of the learners to join the line one by one forming a line with all of the estimates in order from smallest to largest. Make a bar graph with appropriate, evenly spaced intervals on the board, and have the learners attach their estimates using sticky tape or Prestik.
- Now hand out identical strips of paper exactly 13 cm long to each pair and have the learners measure them to the nearest centimetre. They should write down their answers. As they are measuring, walk from desk to desk and help any learners who need help using the ruler. In this activity everyone should succeed in getting the same correct answer.
- Ask them to imagine and describe what the graph would look like if all the estimates had been the same.
- Now hold up a different strip – longer or shorter - say 10 cm exactly, or 15cm. Again, have them guess in pairs, sort themselves into a line, and then make a graph. Ask and discuss, "How does this graph compare to the last one?"
- Distribute the different length strips and have them measure them to the nearest centimetre and record the measurement in their books. How close was their guess to the correct measure the first time? How close was it the second time? Why was it different?

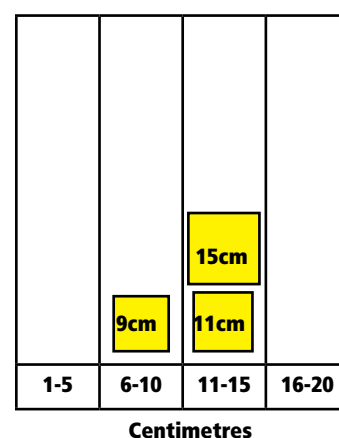
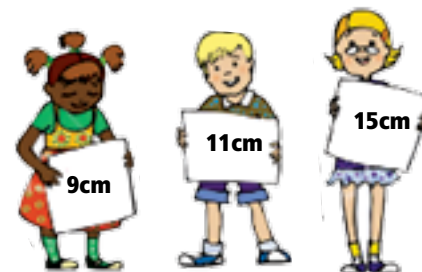

### Step two: How tall will you grow this year?

- Ask the learners to think about how to measure their partner's height as accurately as possible. How do they know if their measurement is accurate?
- Then have them prepare a page in their books to record 5 measurements ( in approximately weeks 1, 10, 20, 30, and 40). On a chosen day they will record their height and how tall they expect to be by the end of the year (week 40).
- On each of the next measuring days they will record their height on that day, how much they have grown since the last measurement, and how tall they now think they will be by the end of the year.
- In week 40, ask each learner whether his estimate improved, got worse, or stayed the same as the year progressed. They can use whole centimetres, or fractions of centimetres when they are able.

Week	Height	Grown since last measurement	Estimate: How tall will I be at week 40?
1			
10			
20			
30			
40			

## Grade 3: Data handling

### Chance and probability

You can integrate graphing activities with games of chance and other activities that use dice, spinners, and coin flipping. Such games help learners to develop intuition about probability and chance, concepts they will encounter in more formal ways in later grades.

#### Sum dice game

Learners play in pairs.

They will need:

2 dice

1 number strip with numbers from 2 to 12

11 counters for each learner.

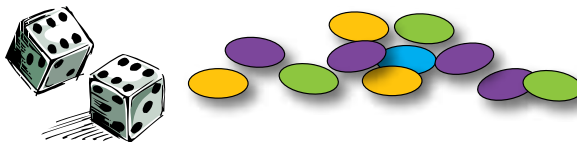

2	3	4	5	6	7	8	9	10	11	12
---	---	---	---	---	---	---	---	----	----	----

- Before they start playing, learners must think about which numbers the 2 dice are likely to land on for different throws. Then they each place their 11 counters above the numbers on the strip to show their predictions in a column graph.

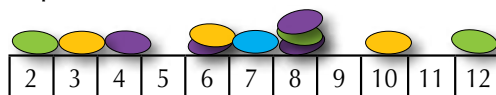

- Once the counters are arranged, players take turns rolling the dice.
- For each roll, both players can remove one counter from the column of the number rolled. The first player to clear her or his column graph is the winner.

Let the learners play the game a few times on different days. Ask them to keep a record of their arrangements, and of who won. Then ask them to share their experiences. Which arrangements were the best? Did any totals come up more frequently than others? Why do they think this happens?

## Vocabulary

If you do not teach in English, use equivalents in your language of instruction.

### Grade 1:

- collect, sort, classify, arrange, compare, order
- graph, pictograph

### Grade 2 - add the following to the Grade 1 vocabulary:

- tally, list, diagram, Carroll diagram, symbol, table

### Grade 3 - add the following to the Grade 1 and 2 vocabulary:

- column, row, bar graph, scale.

## Resources

### Grade 1:

- things that learners can collect and sort
- daily programme, birthday graph
- measuring tools such as arms, feet, hand spans, bottles, buckets, spoons, balances (scales)
- sorting circles (Venn diagrams), concrete graph, pictograph, number line.

### Additional resources for Grade 2 and 3:

- clocks, calendars with important dates, weather chart
- extra measuring tools for distance around a shape and for area such as string and tiles
- tally sheets, Carroll diagram, lists, tables, bar graph.



# Resources

Number cards	344
Clock faces	345
Animal counting cards	346
100s Scatter board	347
Dot cards	348
Spinners	349
Measuring strips	350
Nets - Triangular pyramid	351
Nets - Triangular prism	352
Nets – Cone	353
Nets - Pyramid	354
Nets – Cube	355
Money – 10/20/50 cents	356
Money – 1/2/5 rand	357
Fractions of the hexagon	358
Fractions of the circle	359
Blank number board	360
1 – 100 number board	361
100 – 200 number board	362
201 – 300 number board	363
301 – 400 number board	364
401 – 500 number board	365
Work card	366
Counting objects	367
Work out the number worksheet	368
Word problems worksheet	369
Pattern poster	370
2-D shapes	371
Symmetry	372
2-D shapes and 3-D objects	373
Tangram	374
Grid worksheet	375
Shape worksheet	376
Nets worksheet	377
Time (clock and spinners)	378
Examples of graphs	379
Examples of graphs	380
Visual puzzles worksheet	381
South African stars as calendars	382
Rectangular pyramid net	387
Pentagonal pyramid net	388
Hexagonal pyramid net	389



<b>1</b>	<b>1</b>	<b>0</b>	<b>1</b>	<b>0</b>	<b>0</b>
<b>2</b>	<b>2</b>	<b>0</b>	<b>2</b>	<b>0</b>	<b>0</b>
<b>3</b>	<b>3</b>	<b>0</b>	<b>3</b>	<b>0</b>	<b>0</b>
<b>4</b>	<b>4</b>	<b>0</b>	<b>4</b>	<b>0</b>	<b>0</b>
<b>5</b>	<b>5</b>	<b>0</b>	<b>5</b>	<b>0</b>	<b>0</b>
<b>6</b>	<b>6</b>	<b>0</b>	<b>6</b>	<b>0</b>	<b>0</b>
<b>7</b>	<b>7</b>	<b>0</b>	<b>7</b>	<b>0</b>	<b>0</b>
<b>8</b>	<b>8</b>	<b>0</b>	<b>8</b>	<b>0</b>	<b>0</b>
<b>9</b>	<b>9</b>	<b>0</b>	<b>9</b>	<b>0</b>	<b>0</b>
		<b>1</b>	<b>0</b>	<b>0</b>	<b>0</b>

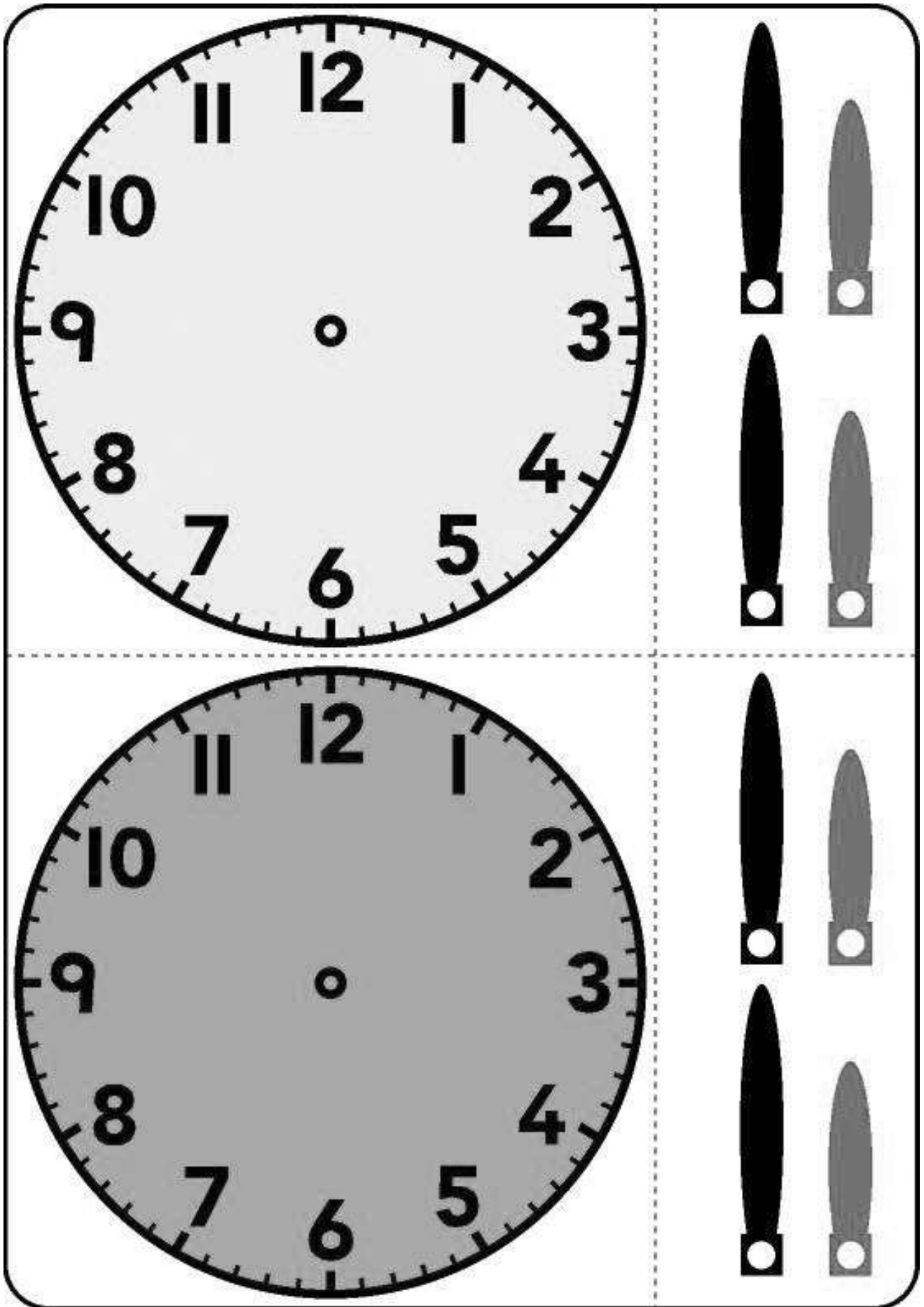

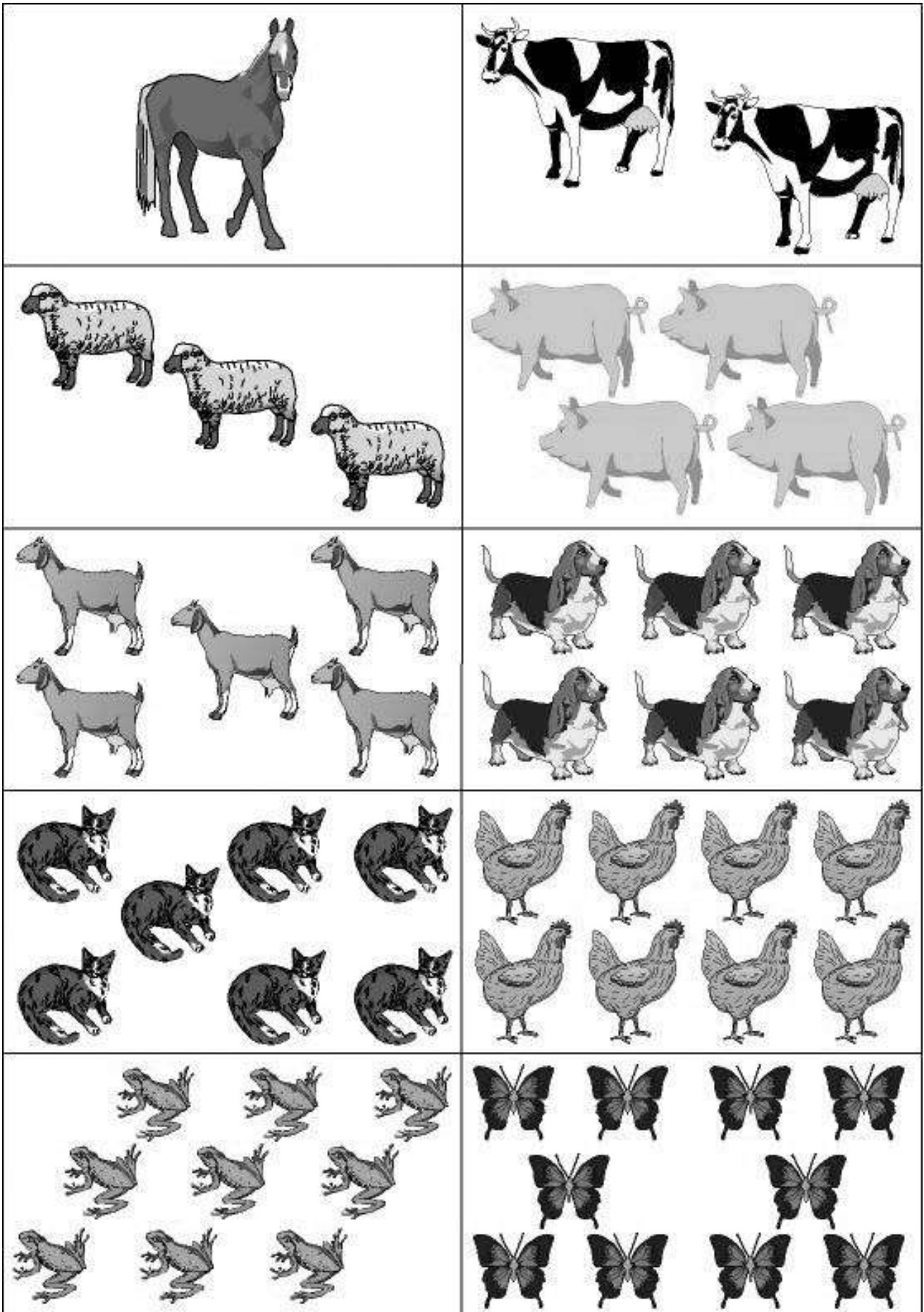

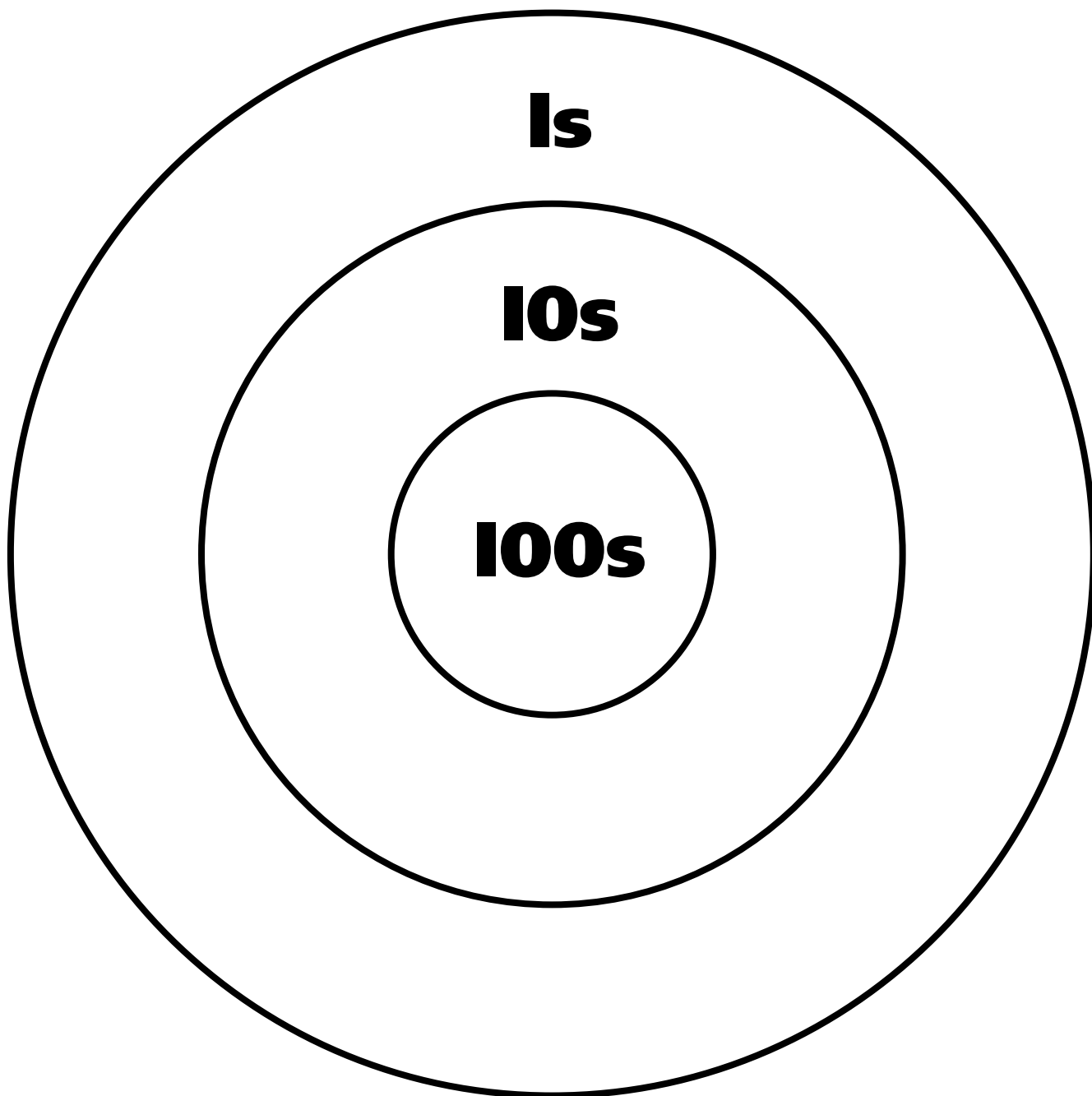

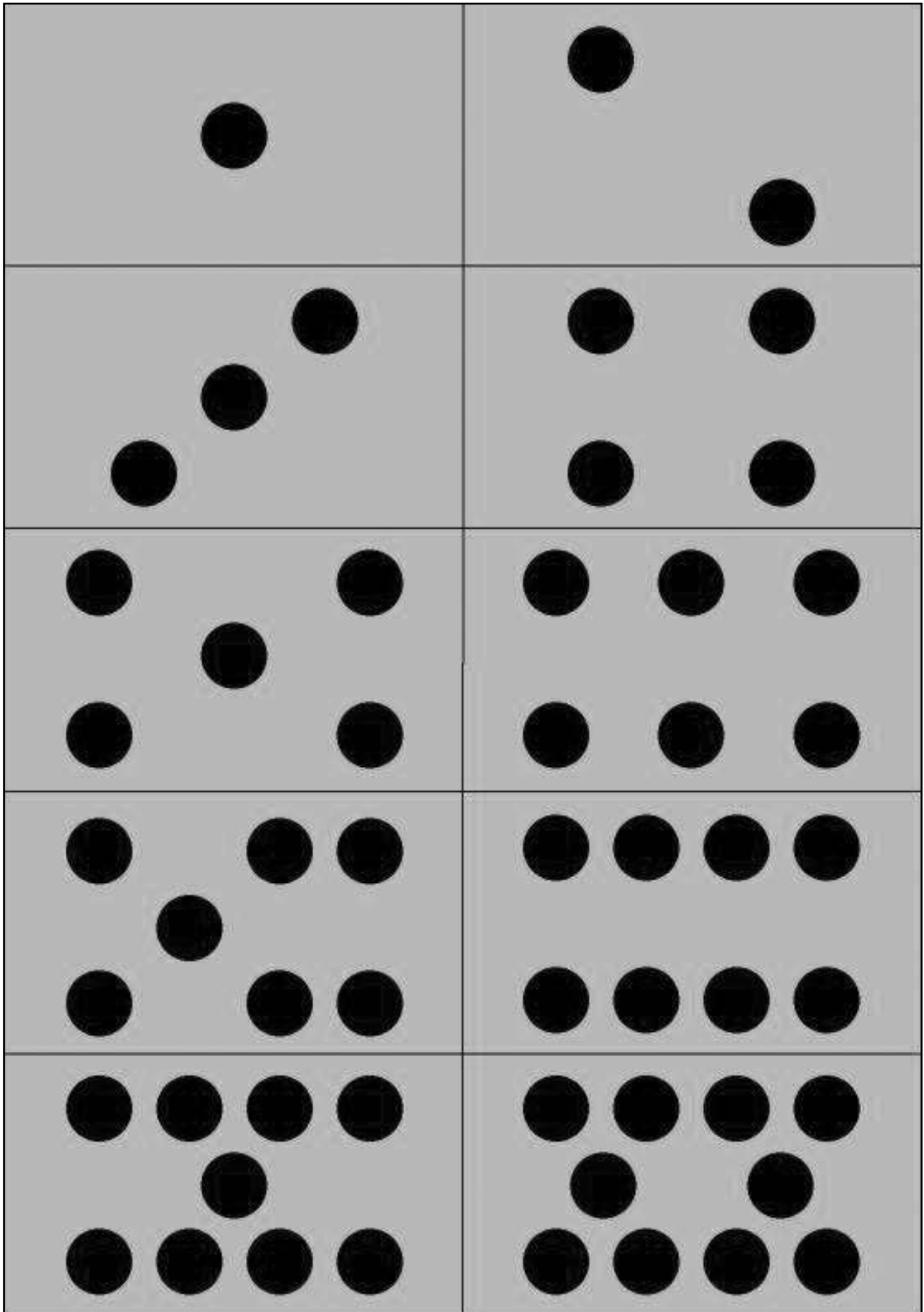

**Resources • Spinners**

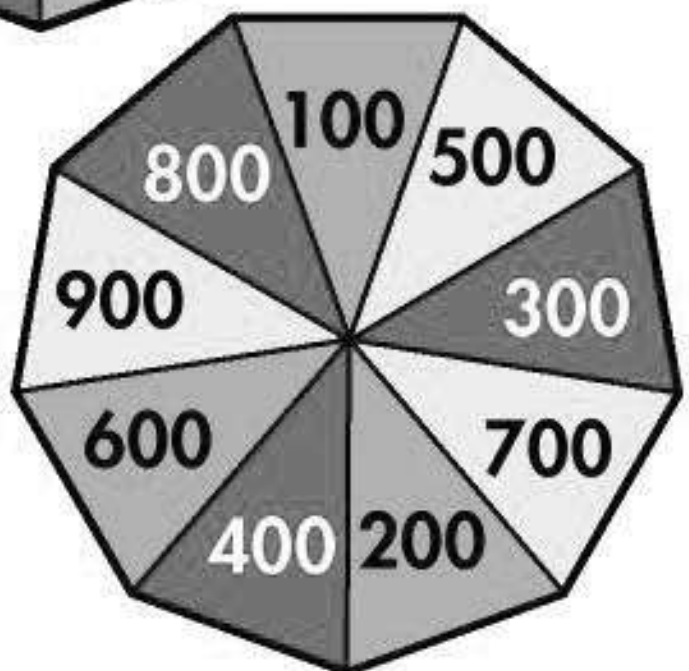
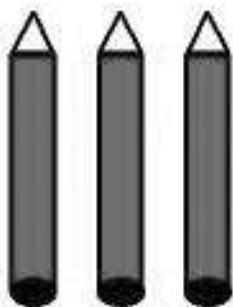
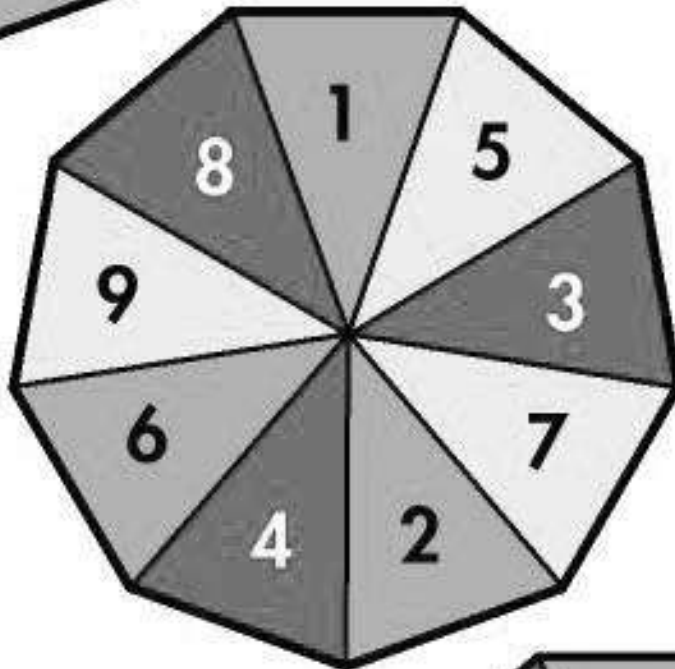
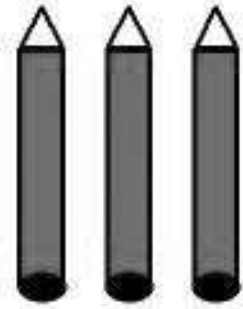
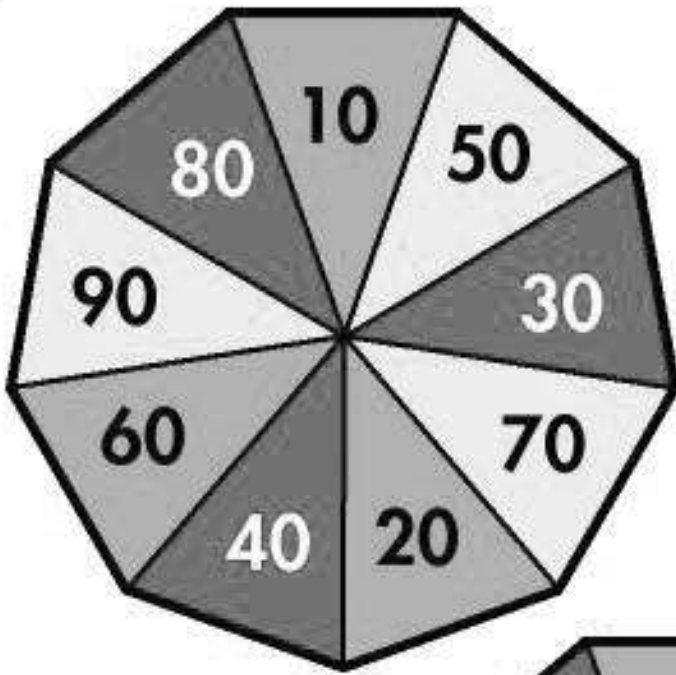



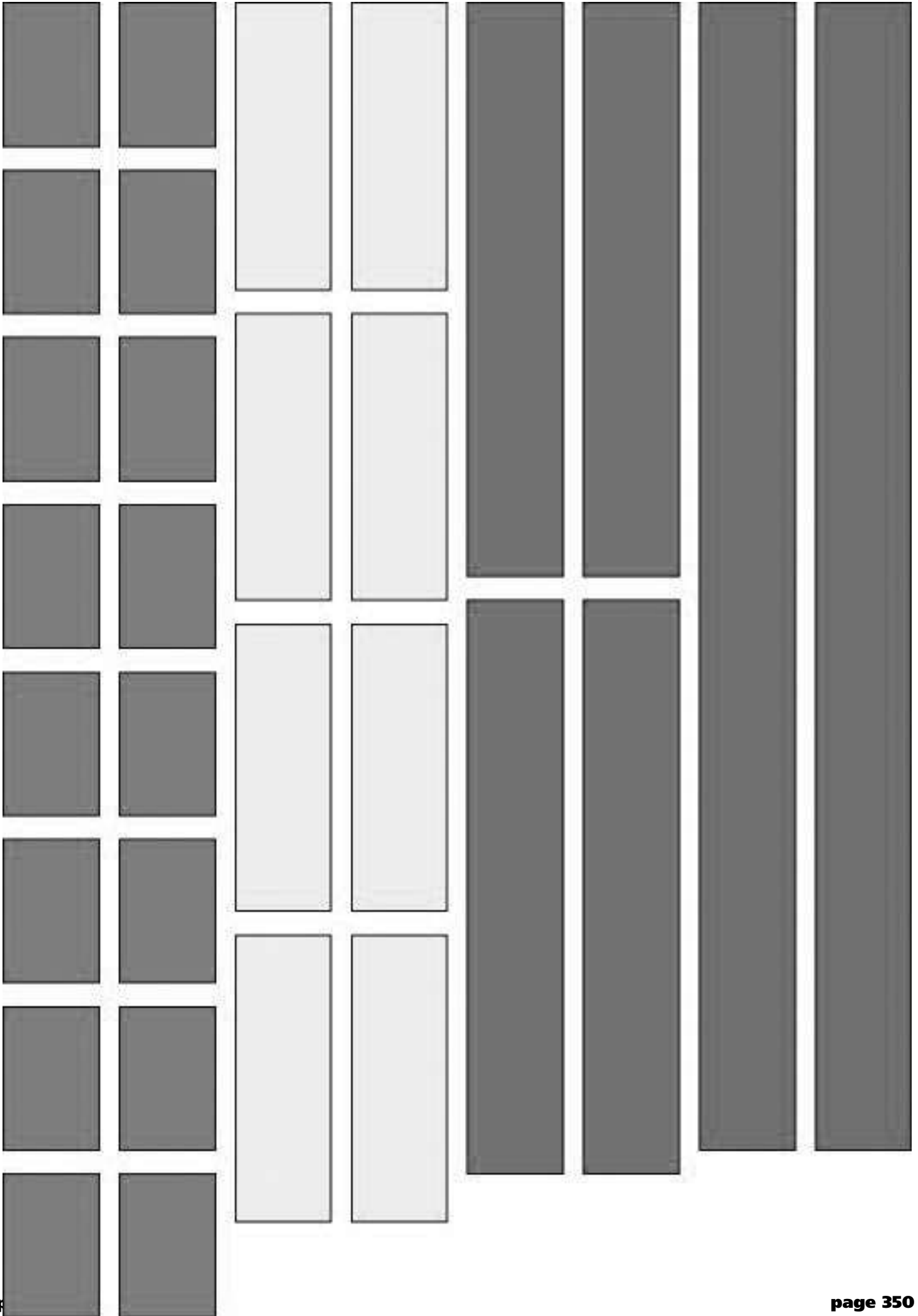

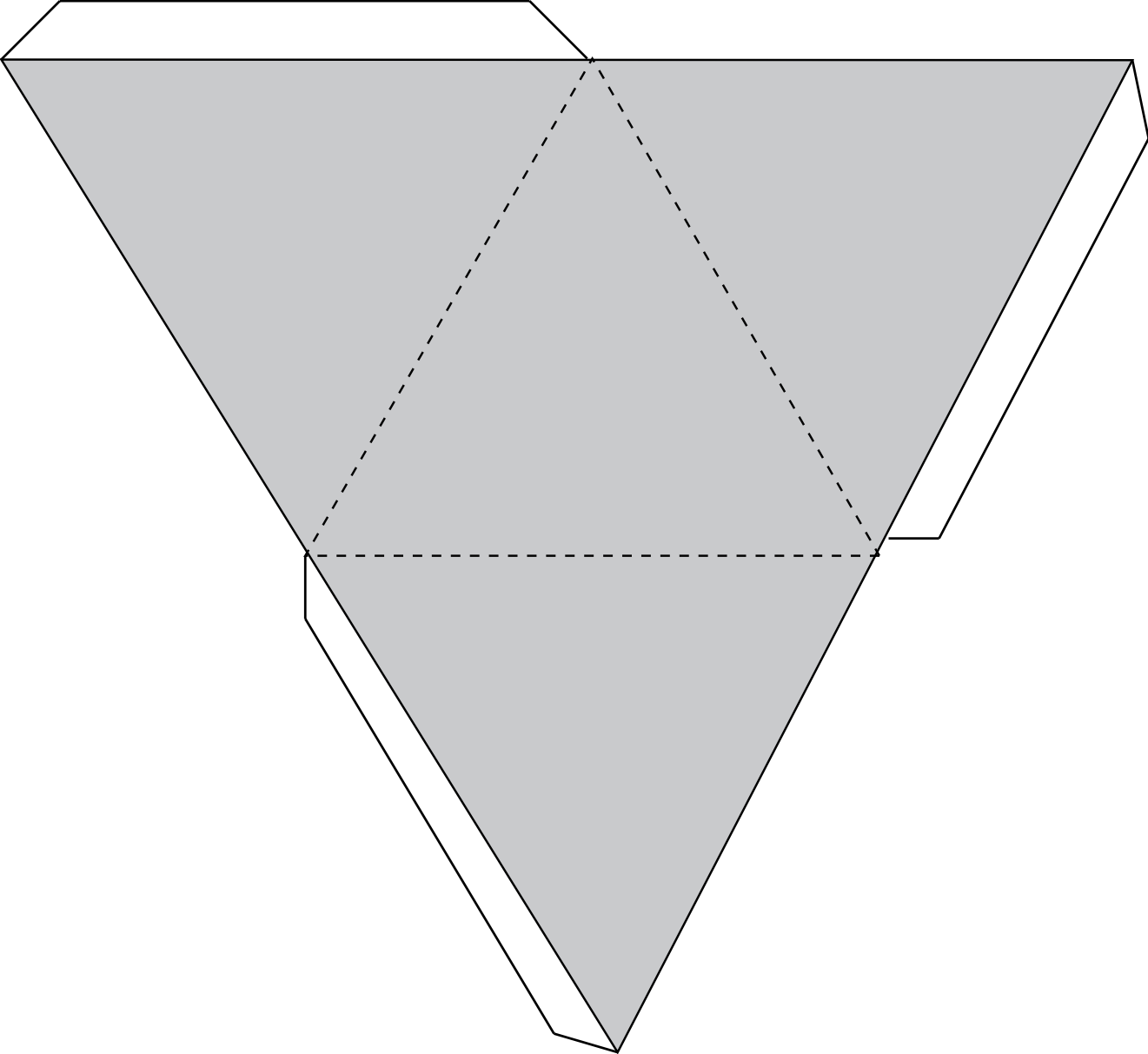

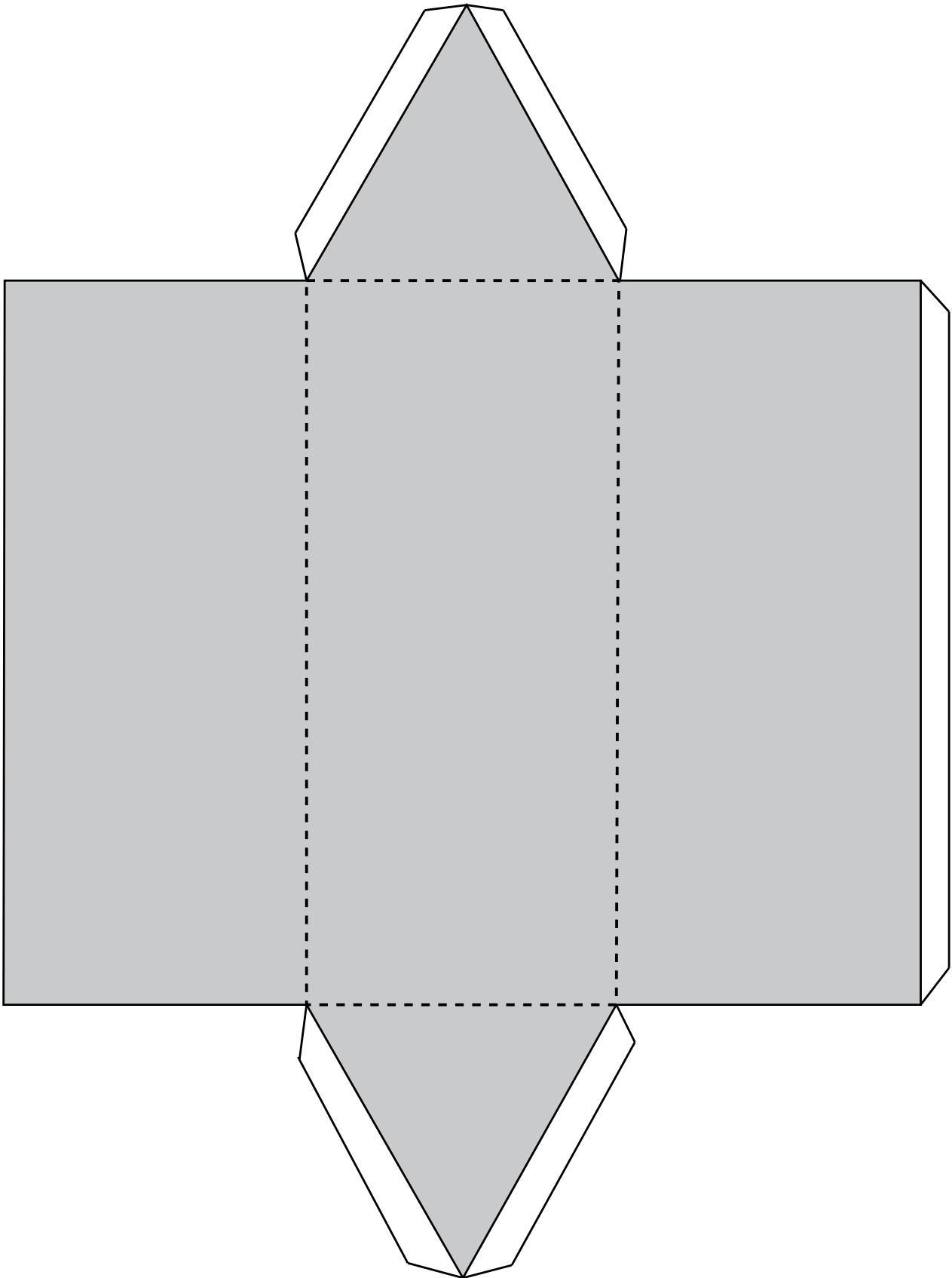

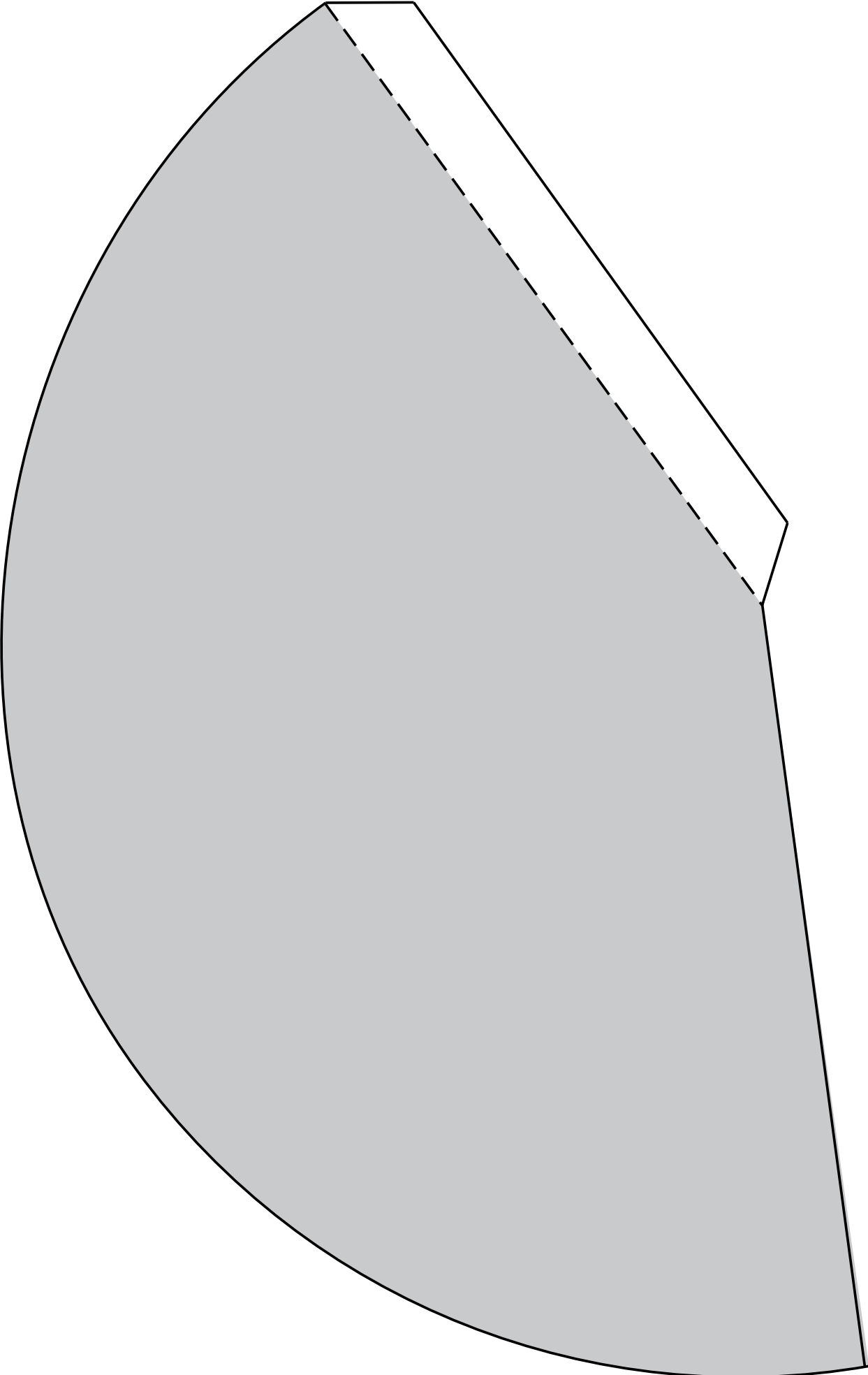

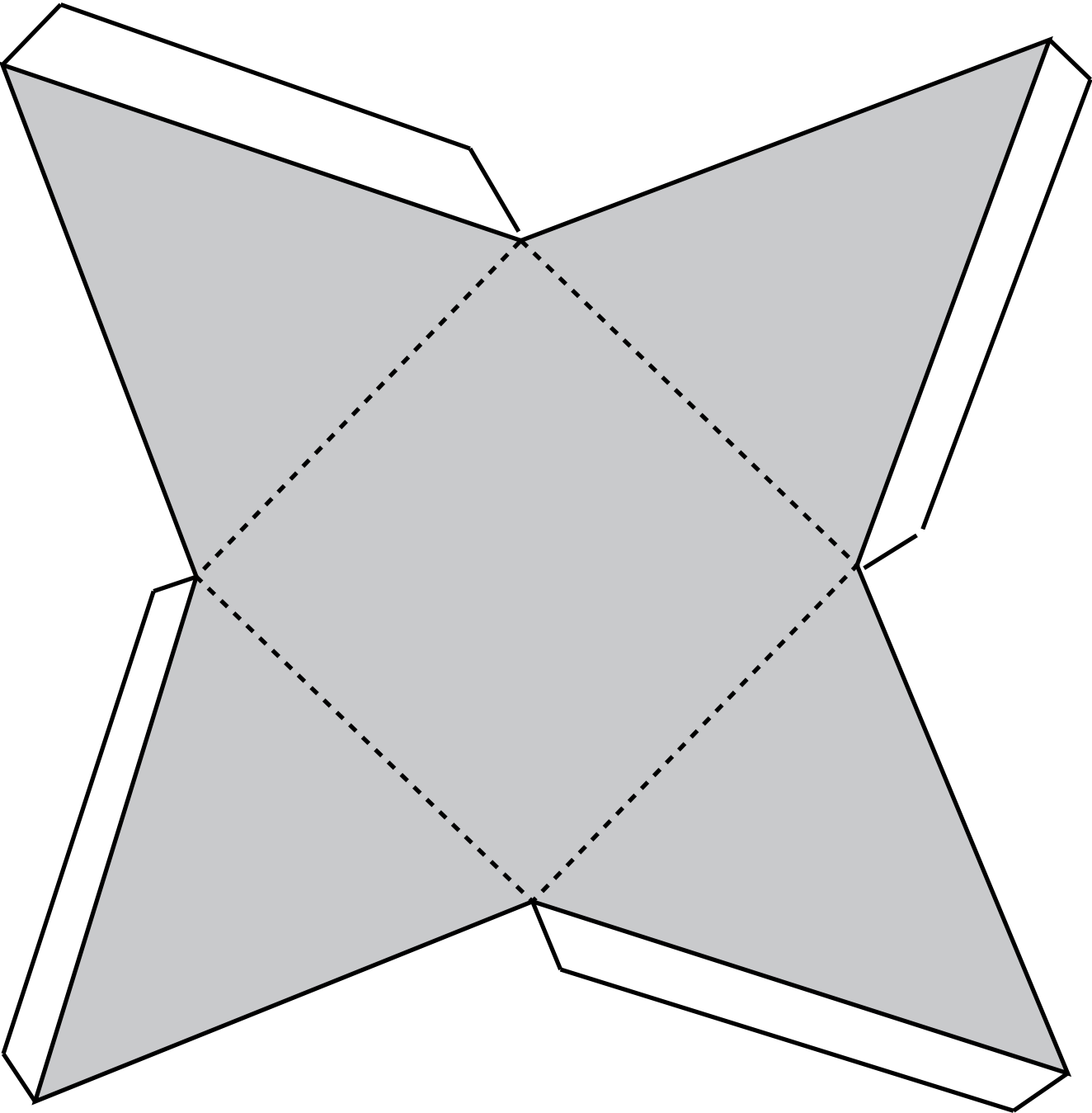

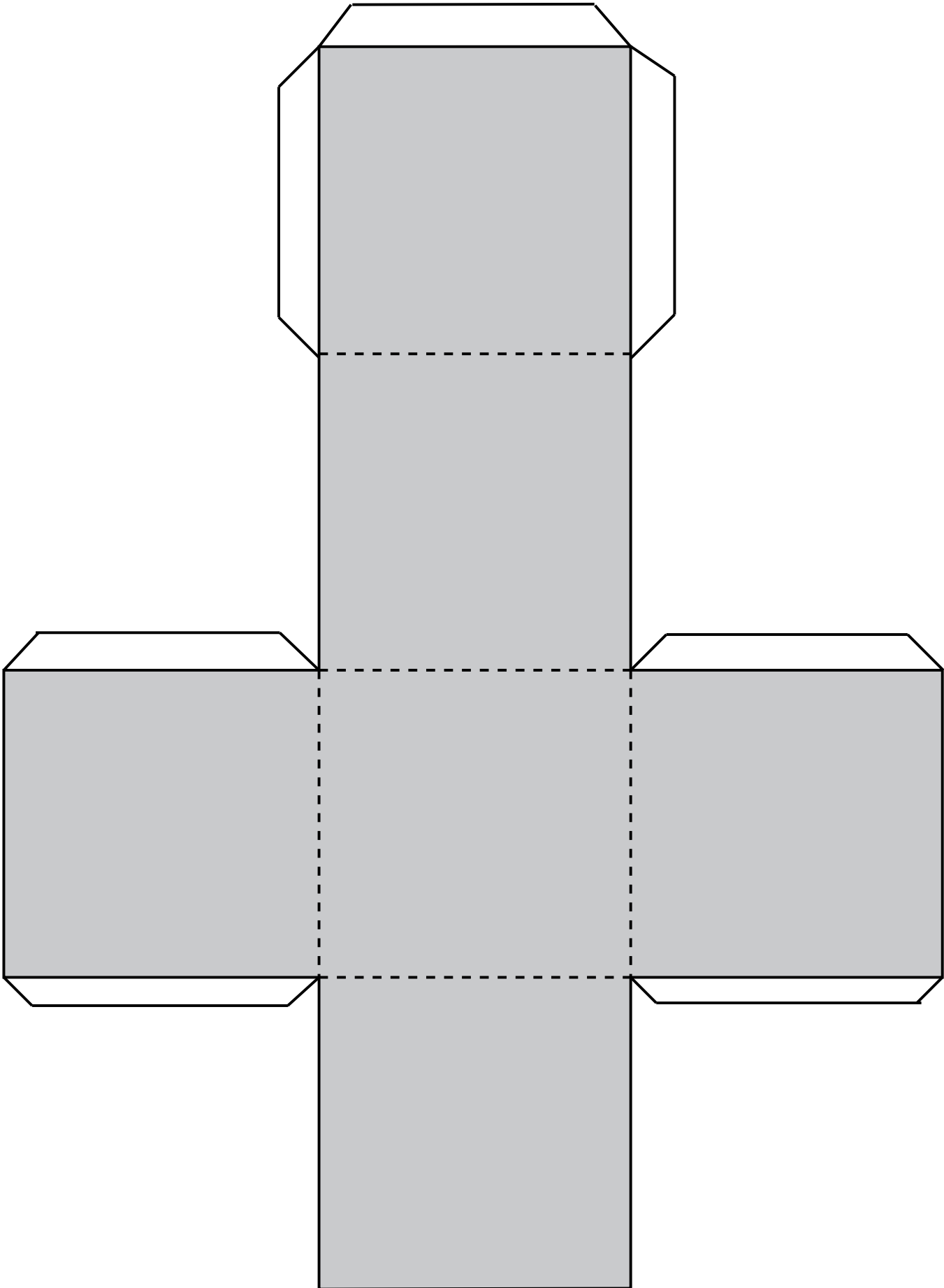



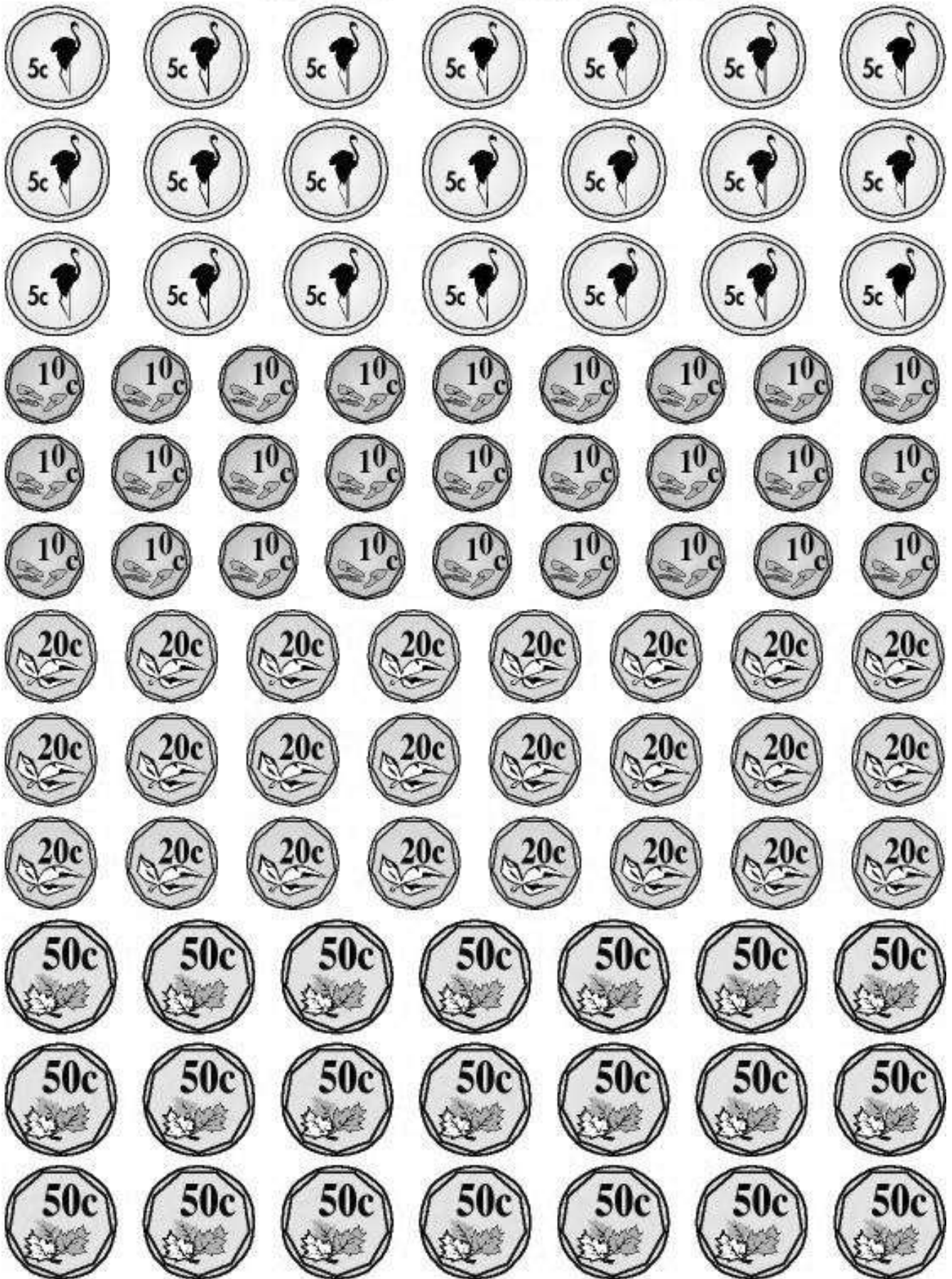

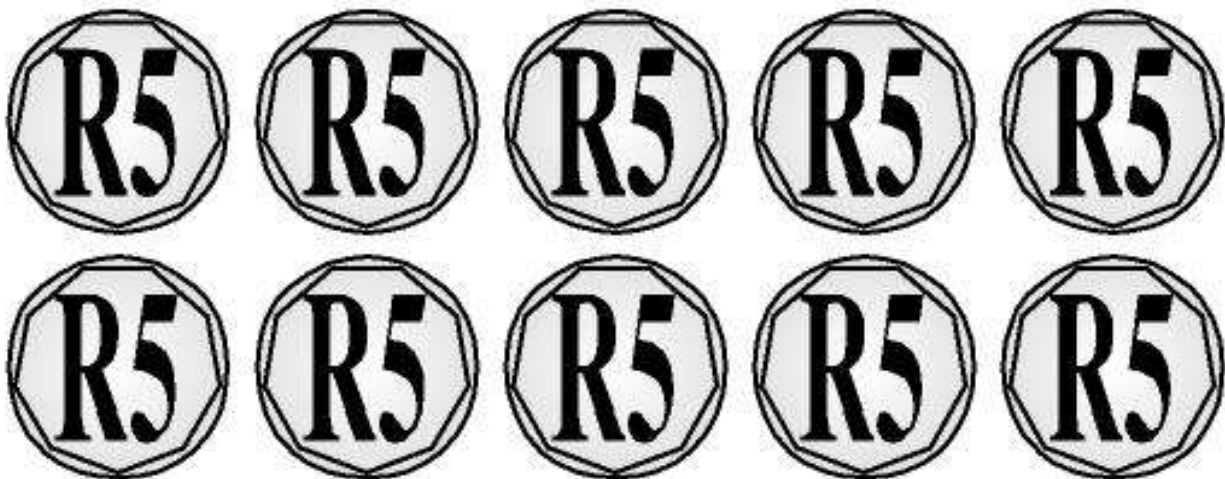
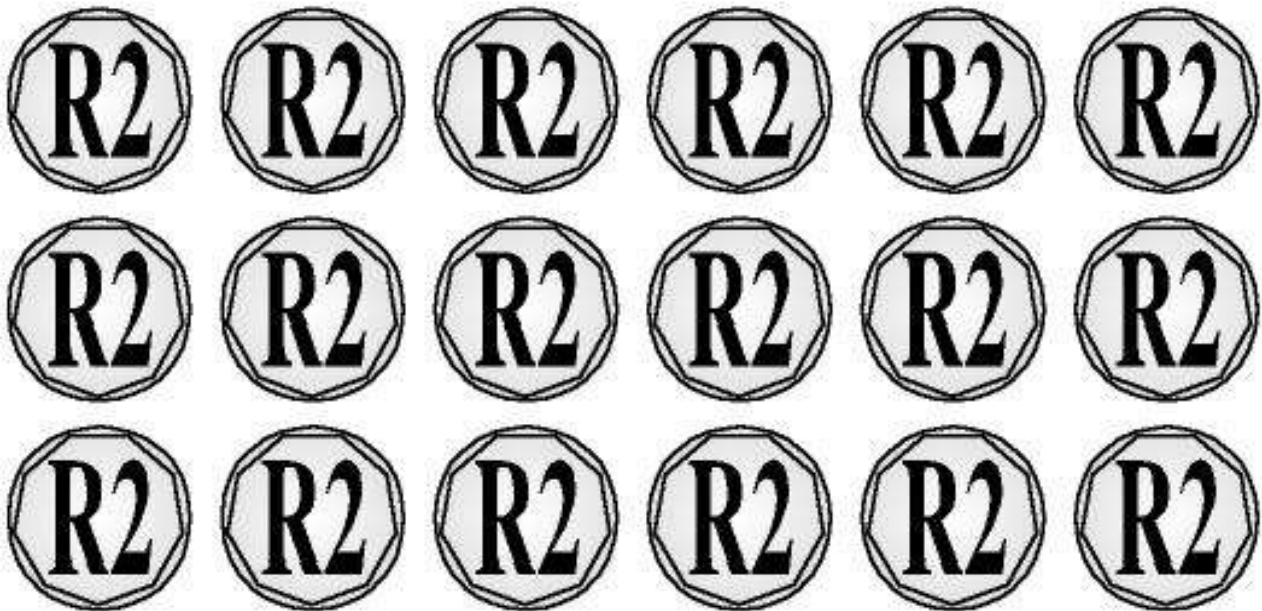
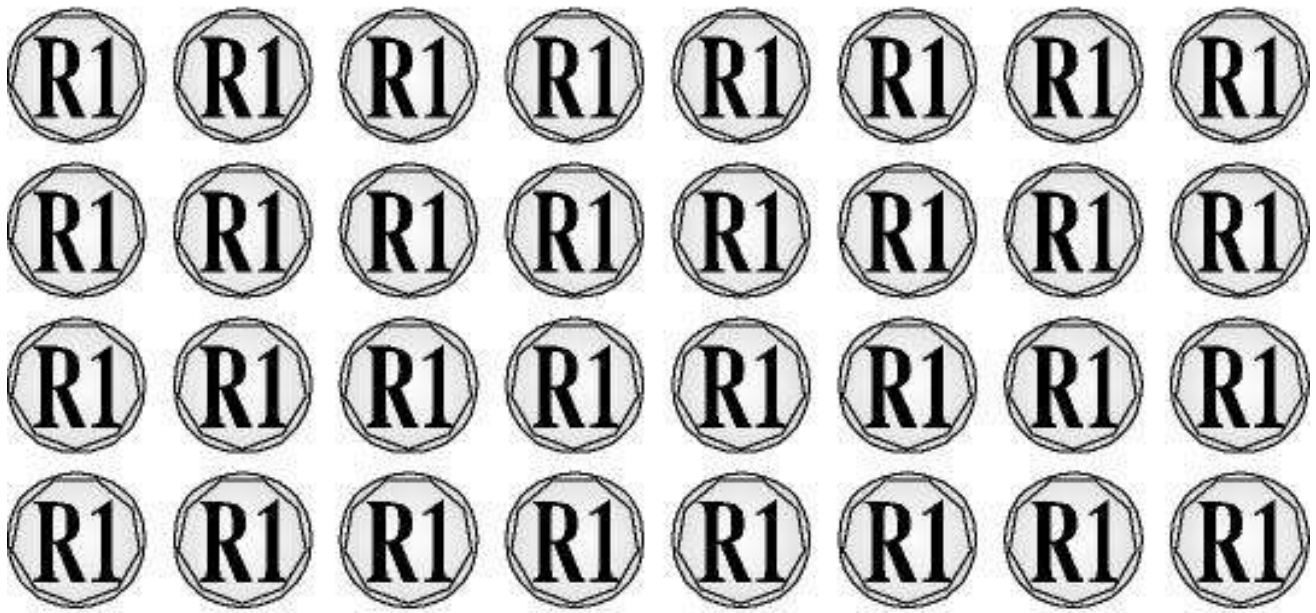

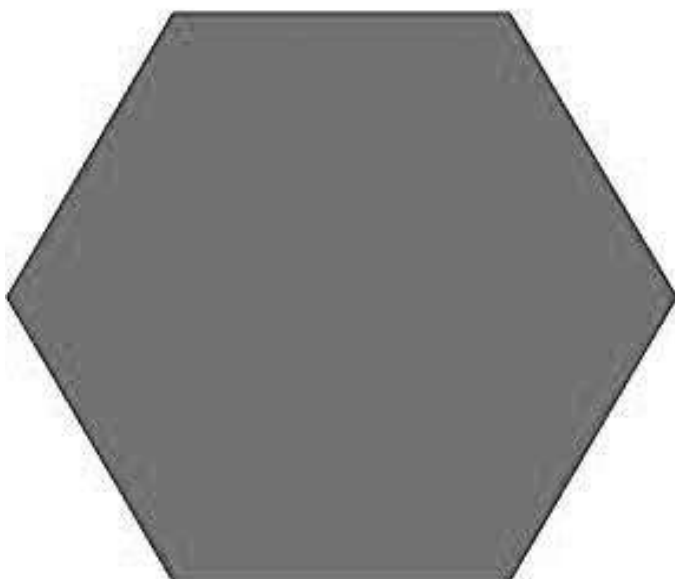
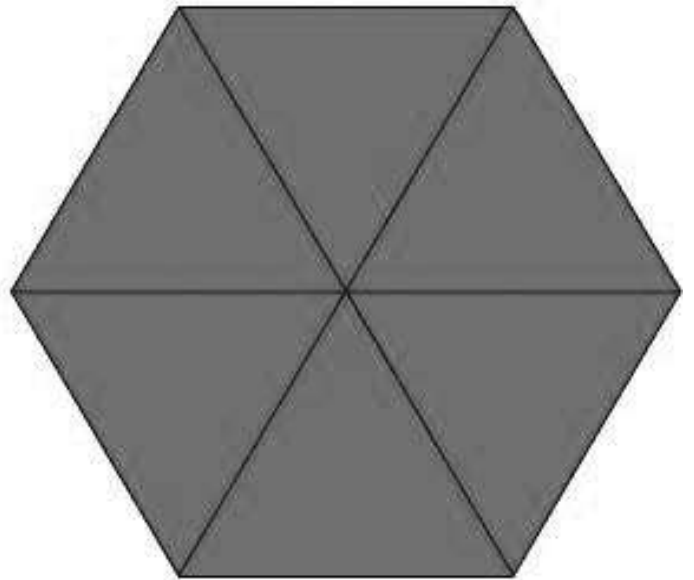
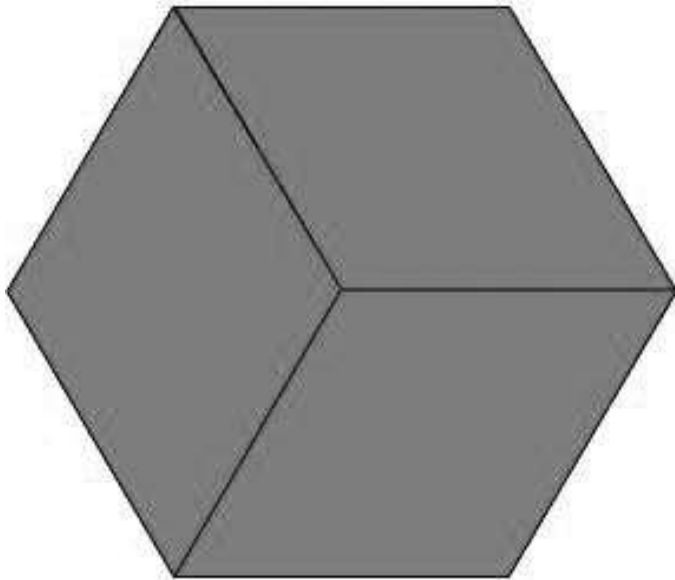
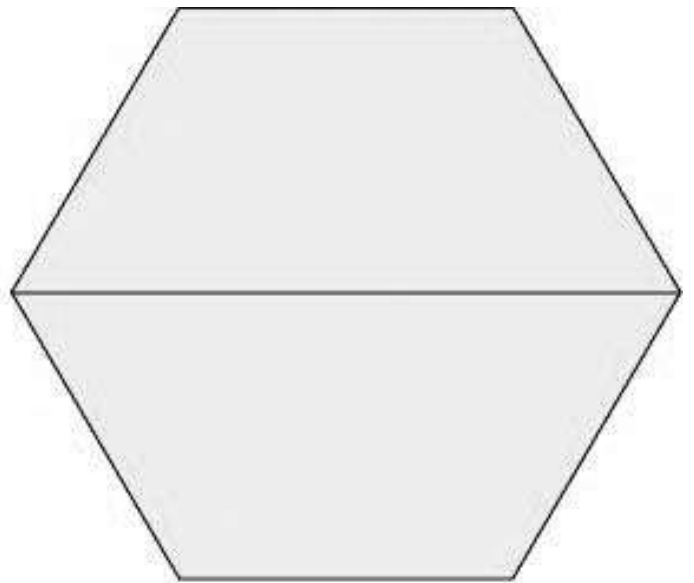
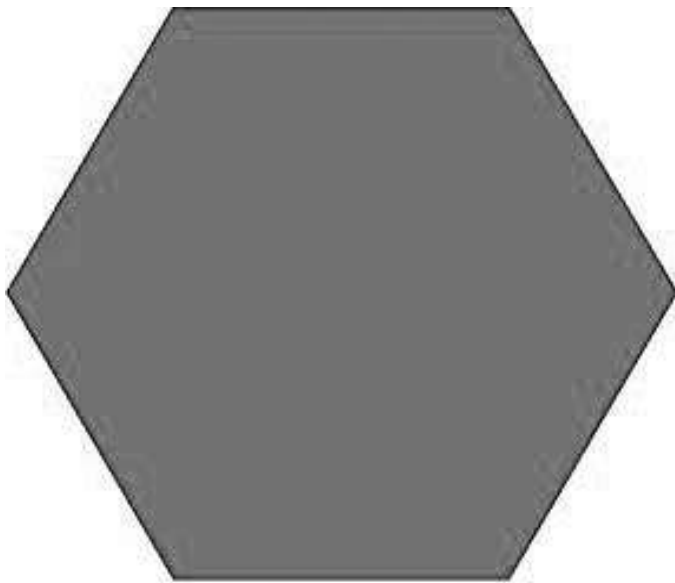

**Resources** • Fractions of the circle

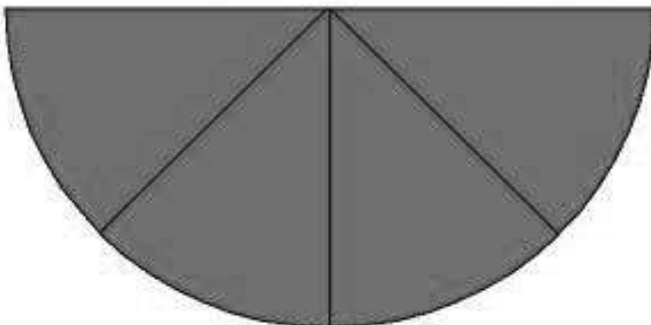
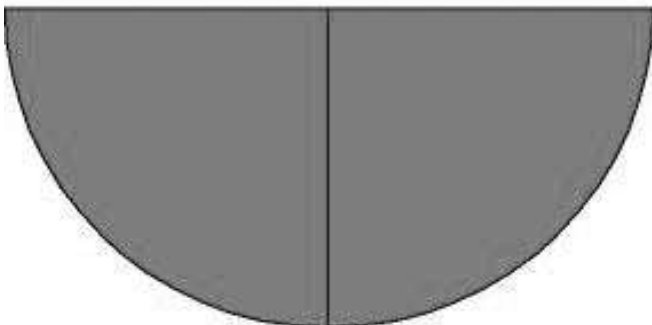
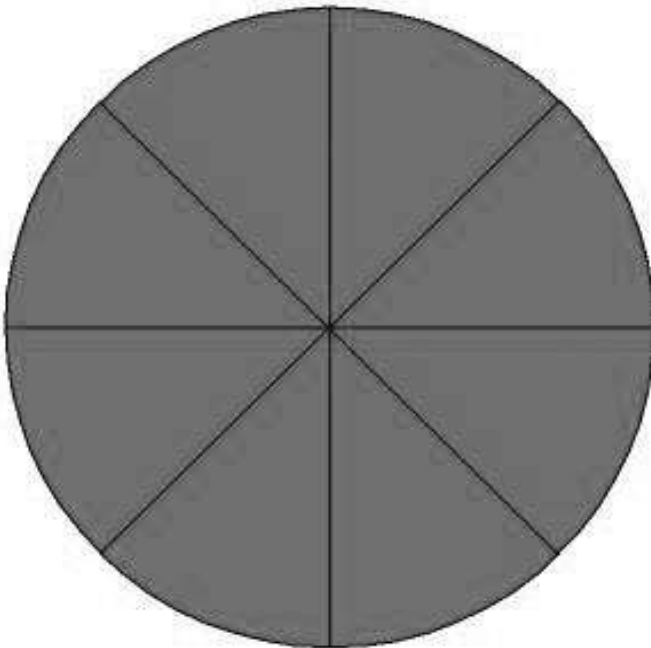
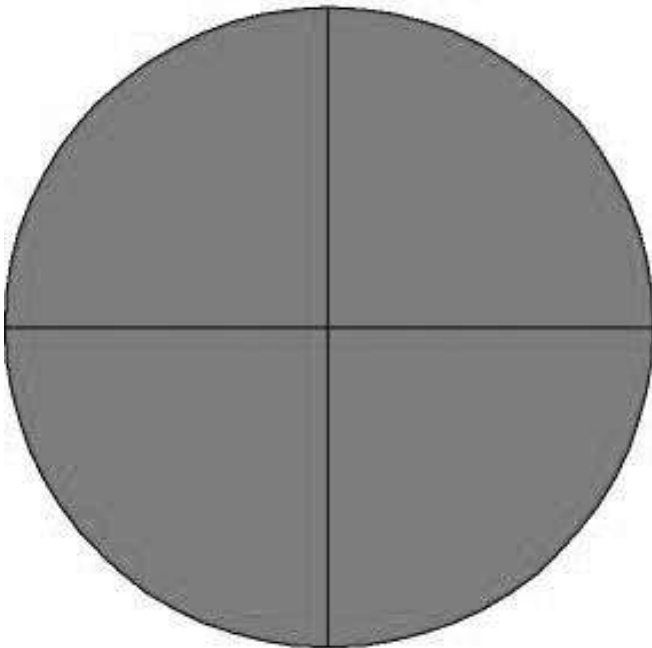
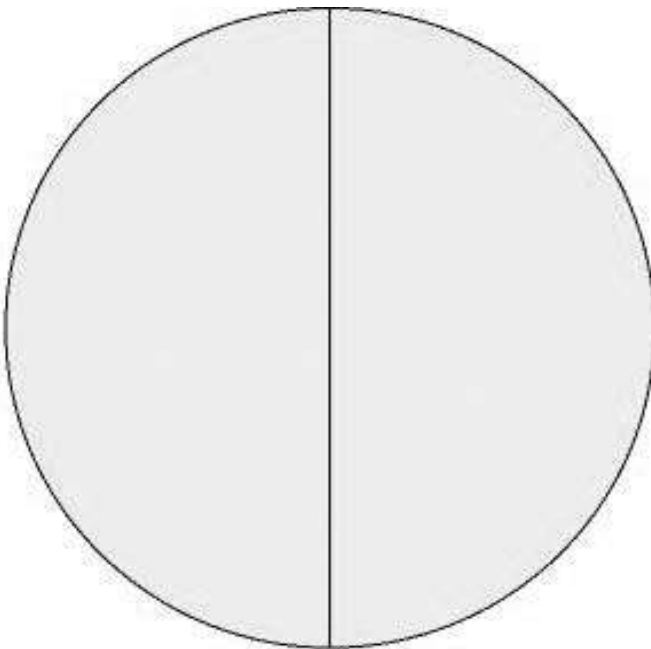
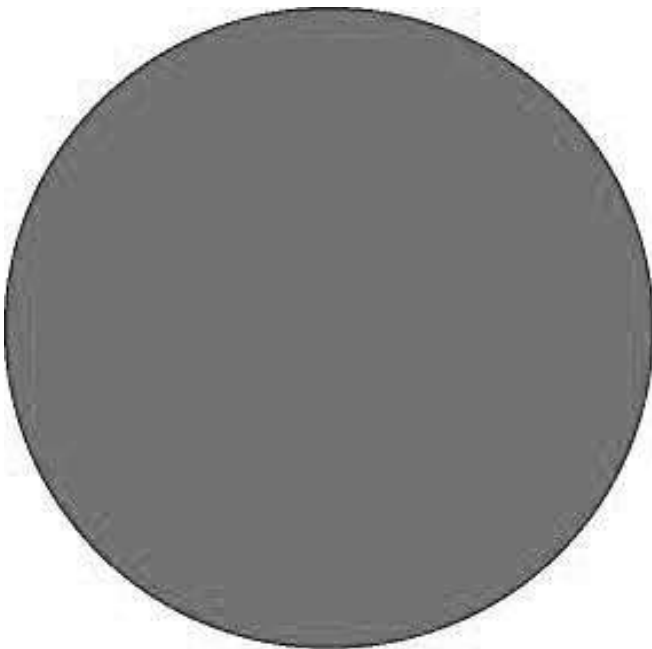

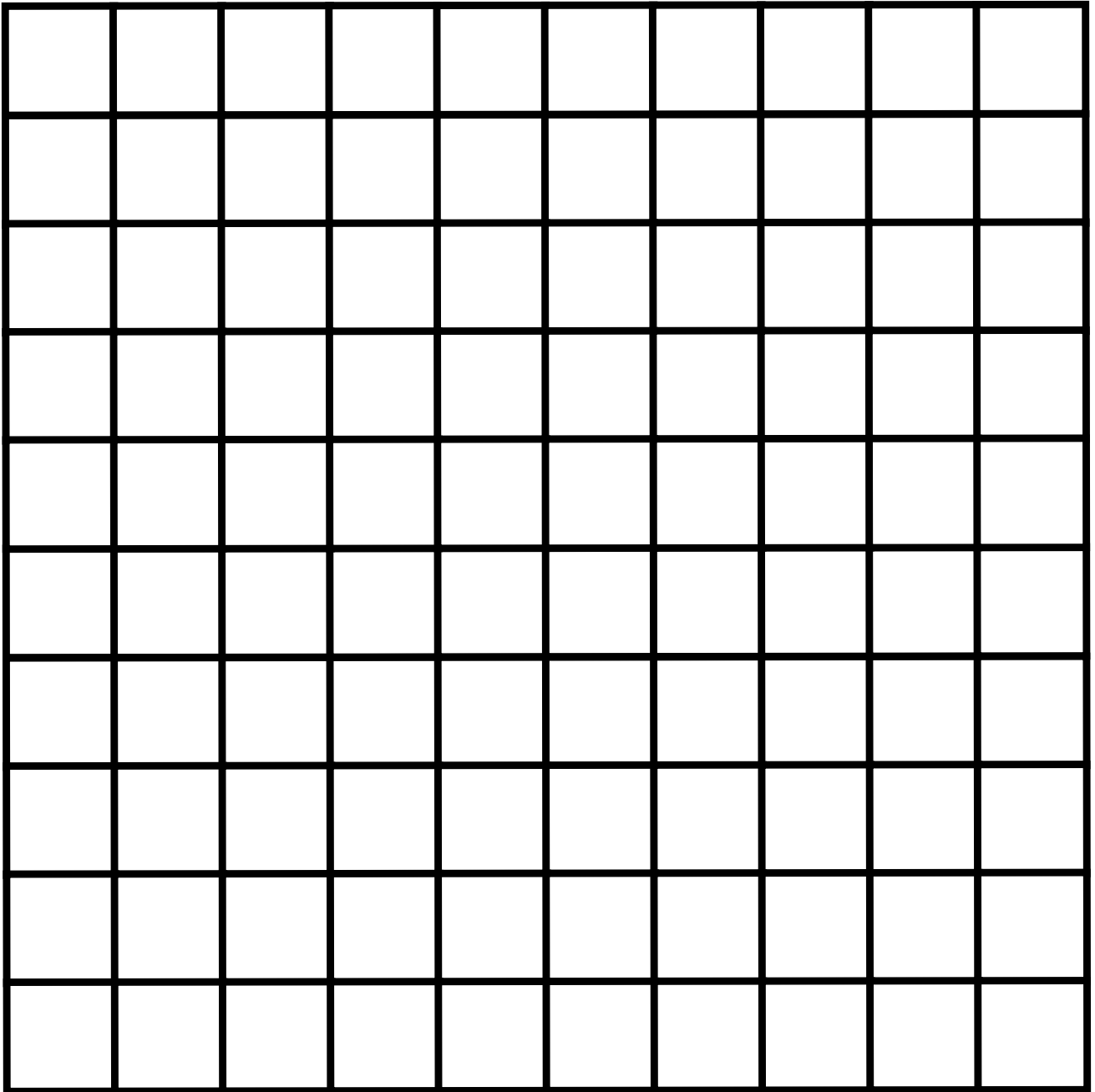

<b>1</b>	<b>2</b>	<b>3</b>	<b>4</b>	<b>5</b>	<b>6</b>	<b>7</b>	<b>8</b>	<b>9</b>	<b>10</b>
<b>11</b>	<b>12</b>	<b>13</b>	<b>14</b>	<b>15</b>	<b>16</b>	<b>17</b>	<b>18</b>	<b>19</b>	<b>20</b>
<b>21</b>	<b>22</b>	<b>23</b>	<b>24</b>	<b>25</b>	<b>26</b>	<b>27</b>	<b>28</b>	<b>29</b>	<b>30</b>
<b>31</b>	<b>32</b>	<b>33</b>	<b>34</b>	<b>35</b>	<b>36</b>	<b>37</b>	<b>38</b>	<b>39</b>	<b>40</b>
<b>41</b>	<b>42</b>	<b>43</b>	<b>44</b>	<b>45</b>	<b>46</b>	<b>47</b>	<b>48</b>	<b>49</b>	<b>50</b>
<b>51</b>	<b>52</b>	<b>53</b>	<b>54</b>	<b>55</b>	<b>56</b>	<b>57</b>	<b>58</b>	<b>59</b>	<b>60</b>
<b>61</b>	<b>62</b>	<b>63</b>	<b>64</b>	<b>65</b>	<b>66</b>	<b>67</b>	<b>68</b>	<b>69</b>	<b>70</b>
<b>71</b>	<b>72</b>	<b>73</b>	<b>74</b>	<b>75</b>	<b>76</b>	<b>77</b>	<b>78</b>	<b>79</b>	<b>80</b>
<b>81</b>	<b>82</b>	<b>83</b>	<b>84</b>	<b>85</b>	<b>86</b>	<b>87</b>	<b>88</b>	<b>89</b>	<b>90</b>
<b>91</b>	<b>92</b>	<b>93</b>	<b>94</b>	<b>95</b>	<b>96</b>	<b>97</b>	<b>98</b>	<b>99</b>	<b>100</b>



<b>101</b>	<b>102</b>	<b>103</b>	<b>104</b>	<b>105</b>	<b>106</b>	<b>107</b>	<b>108</b>	<b>109</b>	<b>110</b>
<b>111</b>	<b>112</b>	<b>113</b>	<b>114</b>	<b>115</b>	<b>116</b>	<b>117</b>	<b>118</b>	<b>119</b>	<b>120</b>
<b>121</b>	<b>122</b>	<b>123</b>	<b>124</b>	<b>125</b>	<b>126</b>	<b>127</b>	<b>128</b>	<b>129</b>	<b>130</b>
<b>131</b>	<b>132</b>	<b>133</b>	<b>134</b>	<b>135</b>	<b>136</b>	<b>137</b>	<b>138</b>	<b>139</b>	<b>140</b>
<b>141</b>	<b>142</b>	<b>143</b>	<b>144</b>	<b>145</b>	<b>146</b>	<b>147</b>	<b>148</b>	<b>149</b>	<b>150</b>
<b>151</b>	<b>152</b>	<b>153</b>	<b>154</b>	<b>155</b>	<b>156</b>	<b>157</b>	<b>158</b>	<b>159</b>	<b>160</b>
<b>161</b>	<b>162</b>	<b>163</b>	<b>164</b>	<b>165</b>	<b>166</b>	<b>167</b>	<b>168</b>	<b>169</b>	<b>170</b>
<b>171</b>	<b>172</b>	<b>173</b>	<b>174</b>	<b>175</b>	<b>176</b>	<b>177</b>	<b>178</b>	<b>179</b>	<b>180</b>
<b>181</b>	<b>182</b>	<b>183</b>	<b>184</b>	<b>185</b>	<b>186</b>	<b>187</b>	<b>188</b>	<b>189</b>	<b>190</b>
<b>191</b>	<b>192</b>	<b>193</b>	<b>194</b>	<b>195</b>	<b>196</b>	<b>197</b>	<b>198</b>	<b>199</b>	<b>200</b>

**Resources • 201 – 300 number board**

201	202	203	204	205	206	207	208	209	210
211	212	213	214	215	216	217	218	219	220
221	222	223	224	225	226	227	228	229	230
231	232	233	234	235	236	237	238	239	240
241	242	243	244	245	246	247	248	249	250
251	252	253	254	255	256	257	258	259	260
261	262	263	264	265	266	267	268	269	270
271	272	273	274	275	276	277	278	279	280
281	282	283	284	285	286	287	288	289	290
291	292	293	294	295	296	297	298	299	300

301	302	303	304	305	306	307	308	309	310
311	312	313	314	315	316	317	318	319	320
321	322	323	324	325	326	327	328	329	330
331	332	333	334	335	336	337	338	339	340
341	342	343	344	345	346	347	348	349	350
351	352	353	354	355	356	357	358	359	360
361	362	363	364	365	366	367	368	369	370
371	372	373	374	375	376	377	378	379	380
381	382	383	384	385	386	387	388	389	390
391	392	393	394	395	396	397	398	399	400

**Resources • 401 – 500 number board**

401	402	403	404	405	406	407	408	409	410
411	412	413	414	415	416	417	418	419	420
421	422	423	424	425	426	427	428	429	430
431	432	433	434	435	436	437	438	439	440
441	442	443	444	445	446	447	448	449	450
451	452	453	454	455	456	457	458	459	460
461	462	463	464	465	466	467	468	469	470
471	472	473	474	475	476	477	478	479	480
481	482	483	484	485	486	487	488	489	490
491	492	493	494	495	496	497	498	499	500

$\triangle = 10$   $\square = 1$  What is the number? \_\_\_\_\_

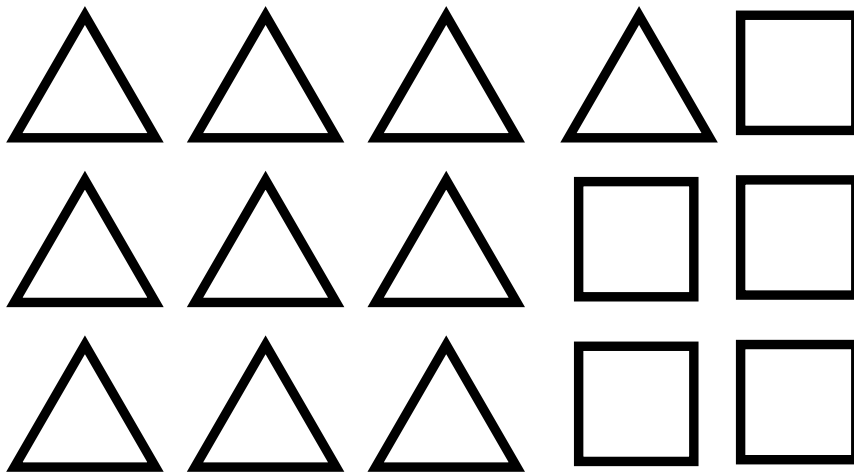

$\triangle = 10$   $\square = 1$  What is the number? \_\_\_\_\_

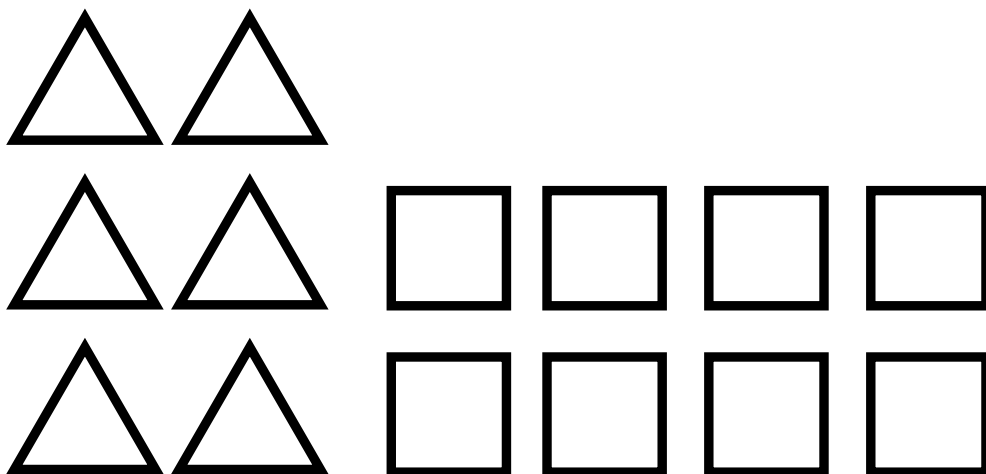

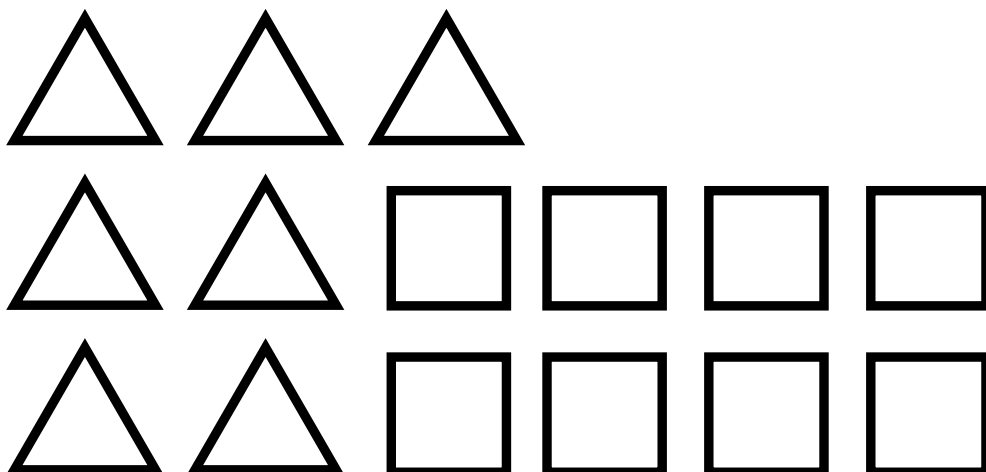

$\triangle = 10$   $\square = 1$  What is the number? \_\_\_\_\_

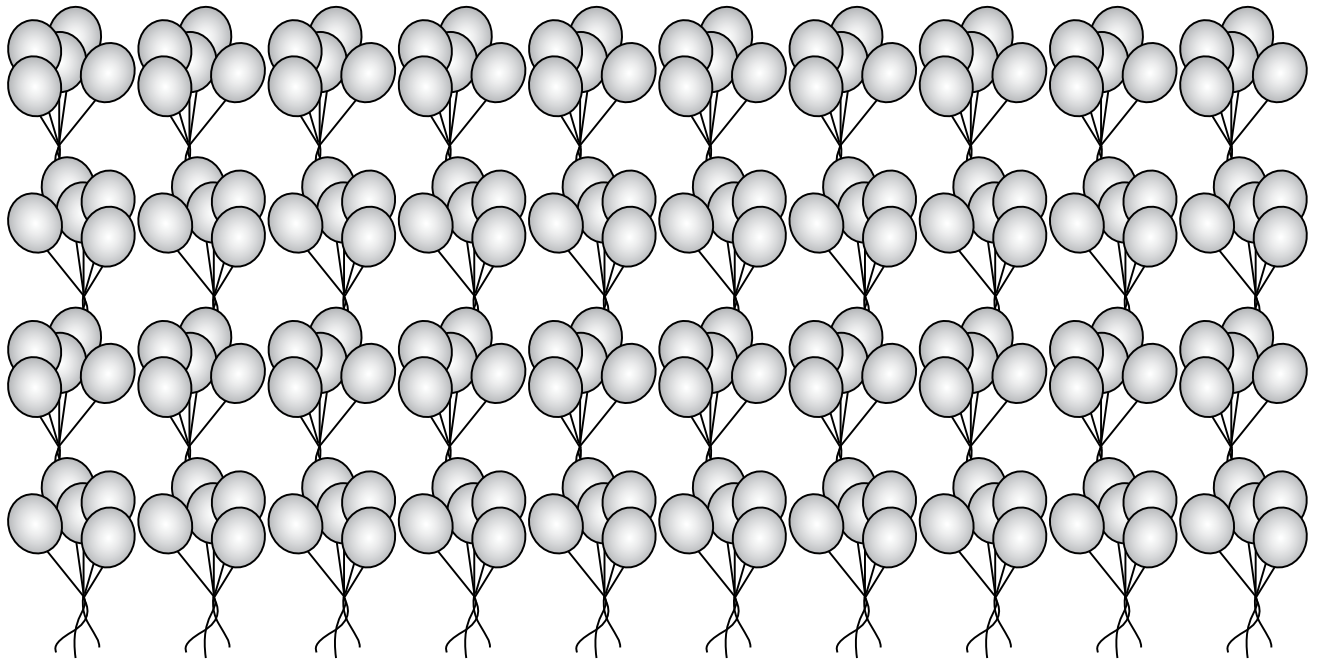
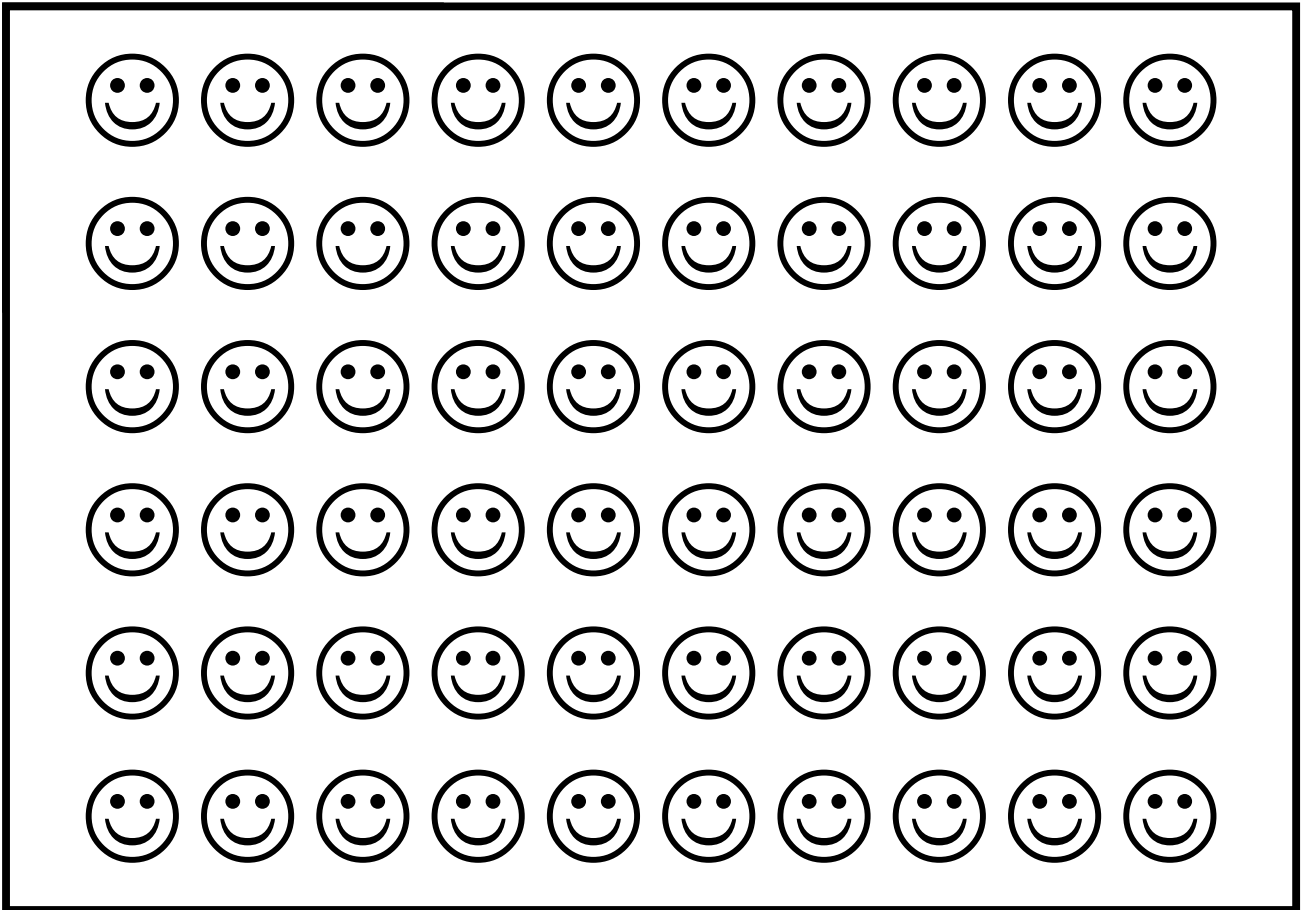







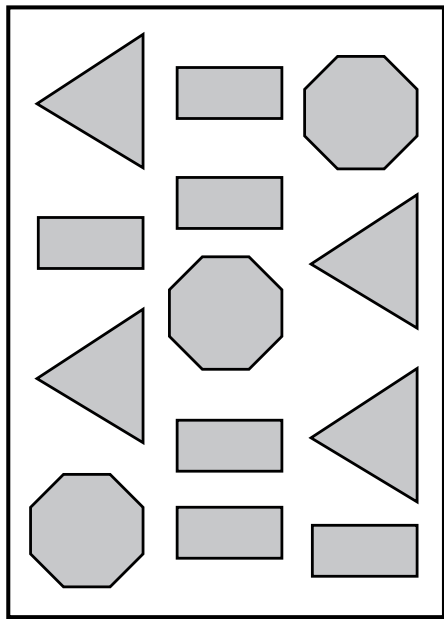
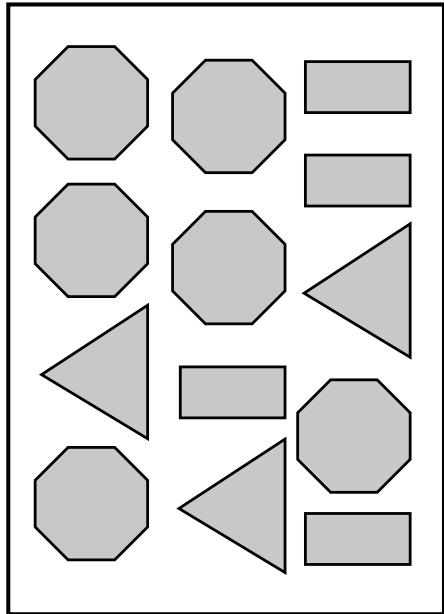
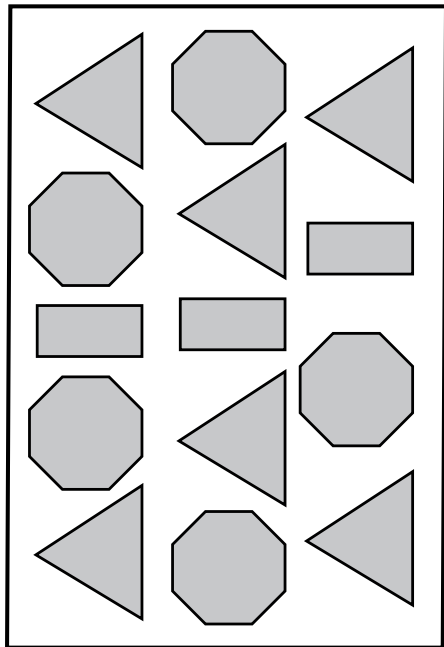

In these drawings:  = 100    = 10    = 1

Work out the number for each box of shapes.



\_\_\_\_\_

- Write your three numbers from smallest to biggest.
- Make your own boxes with different numbers of   and .
- Let your friends write the correct numbers under each box and write the numbers in order from smallest to biggest and from biggest to smallest.



Rashida uses 20c coins to pay for this book.  
How many 20c coins does she use?

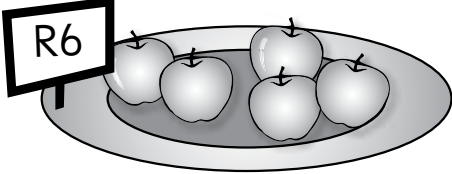

5 apples cost R6.  
How much do 11 apples cost?



The table shows how much pocket money children from three families get.

(a) How much does Child 1 in the Nkosi family get?  
(b) How much pocket money do the children from all 3 families get altogether?

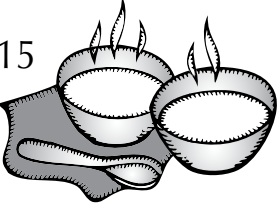
	Venter family	Nkosi family	Patel family
Child 1	R14, 50		R17,50
Child 2	R 4,00	R3,00	R2,75
Total		R19,75	R20,25

R15  R12 

Two plates of porridge cost R15. One plate of porridge + one cup of tea cost R12.  
How much does one plate of porridge cost?  
How much does one cup of tea cost?

Busi's mother gives her some money.  
Busi spends R39. She has R14 left.  
Which of these sums can you use to work out how much money Busi's mother gave her?

$39 + 14 = \square$      $\square - 39 = 14$      $14 \times 39 = \square$      $39 - 14 = \square$

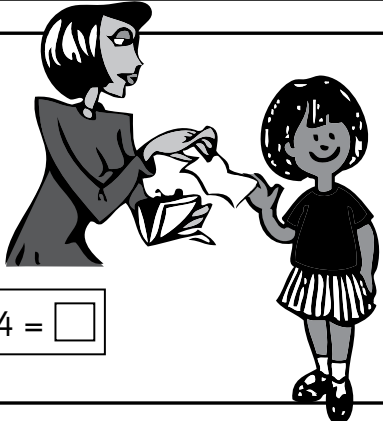



Wind patterns in the sand.



Growing patterns in the rings of tree logs.

The symmetrical pattern of a leaf.



Patterns in flower formations.



Symmetrical designs in African artefacts.



Patterns found in different clothing and textiles.

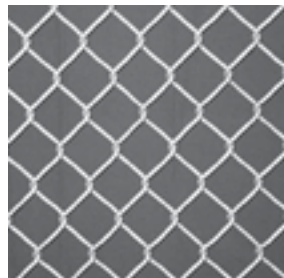

Different fencing patterns.

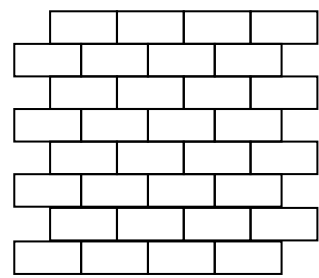
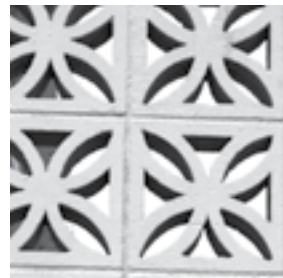

Brick patterns.



Spiral patterns of shells.

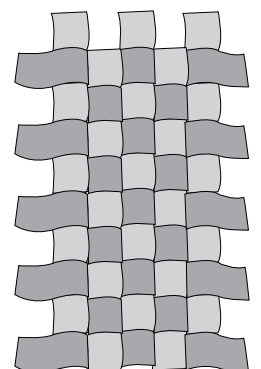
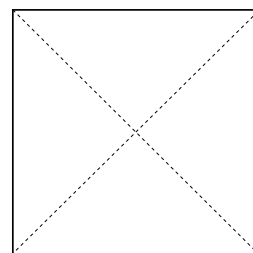

Folding and weaving paper.

**Resources** • 2-D shapes

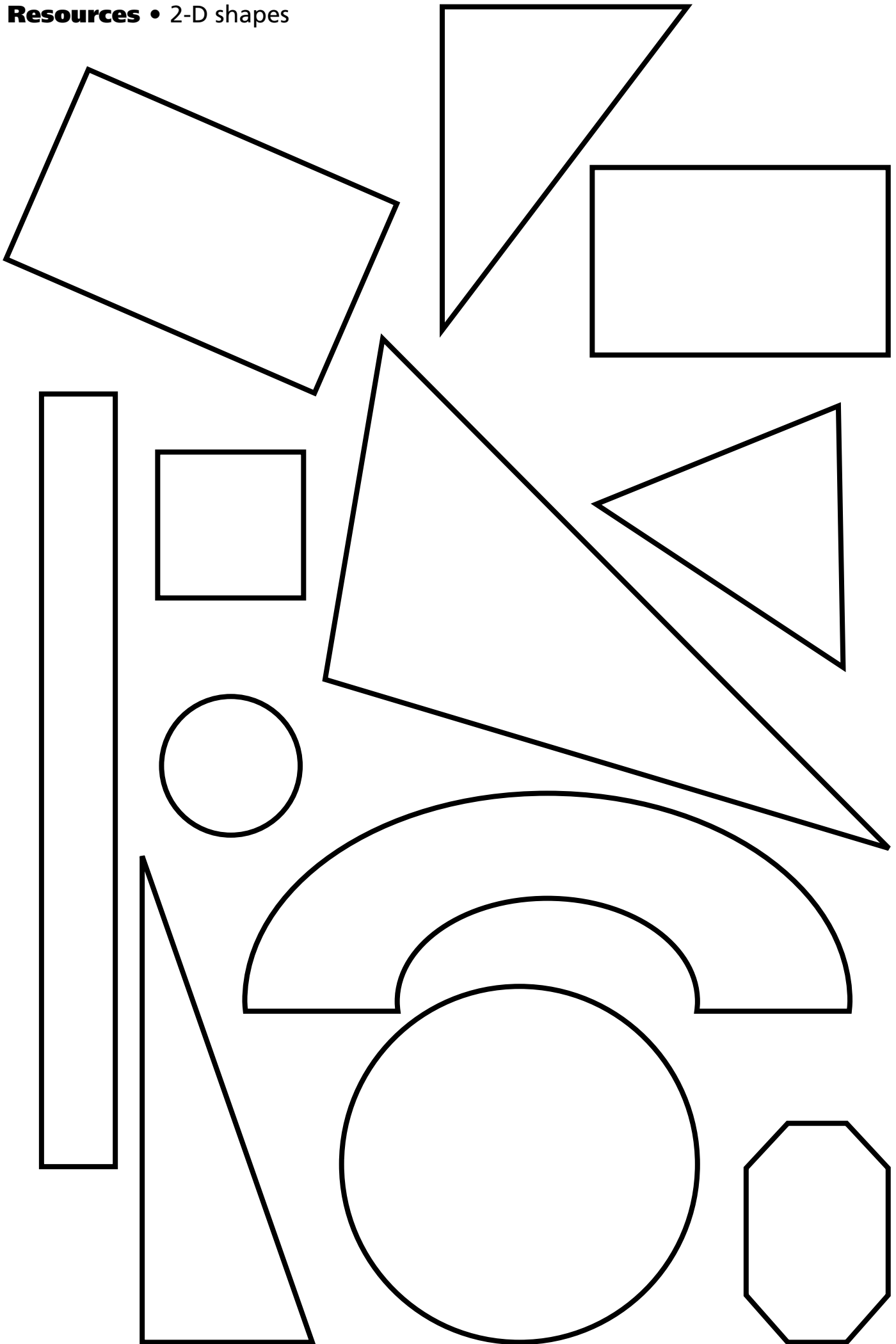

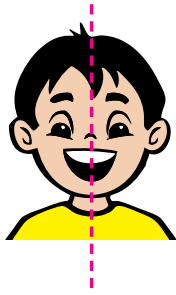

symmetrical



not symmetrical



symmetry

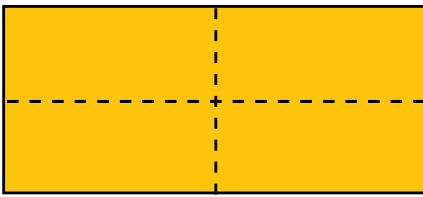

rectangle

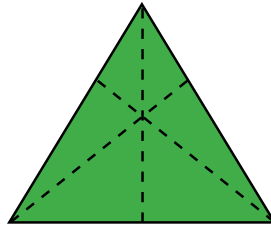

triangle

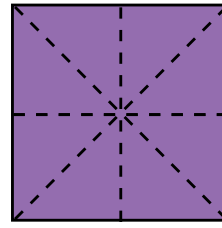

square

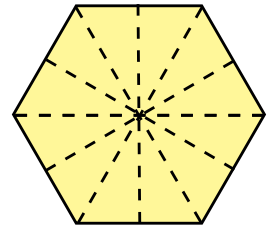

hexagon

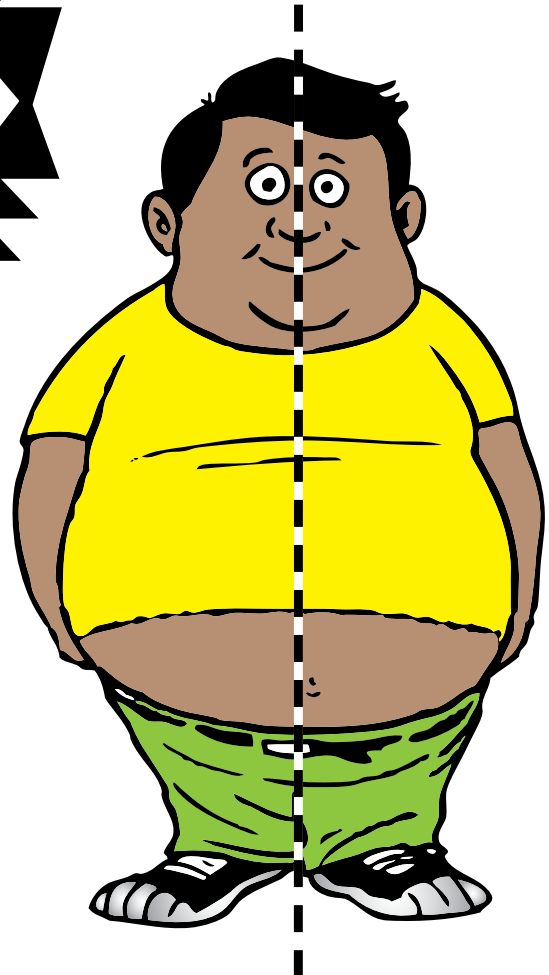
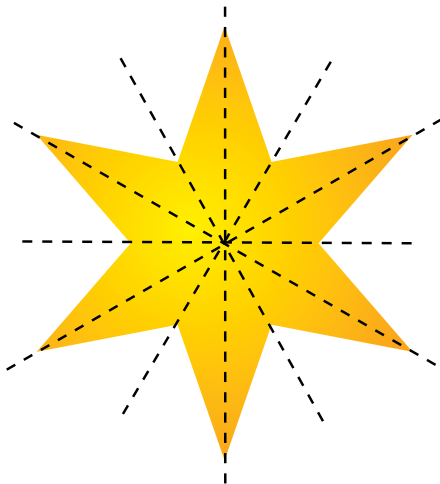
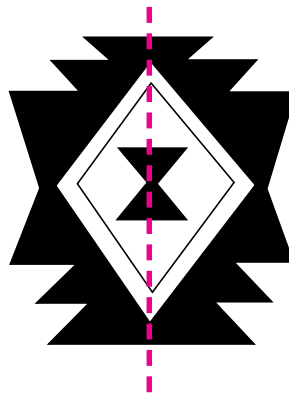
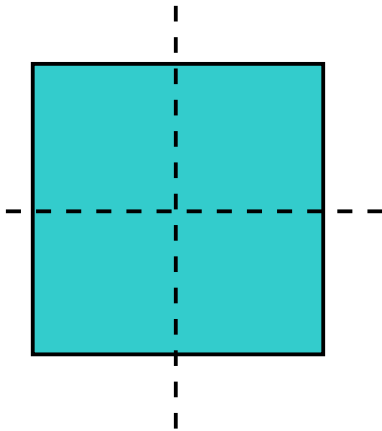

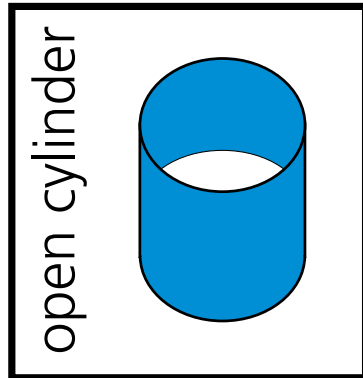
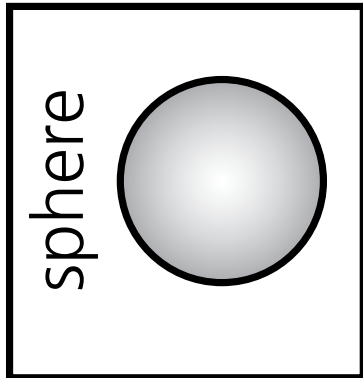
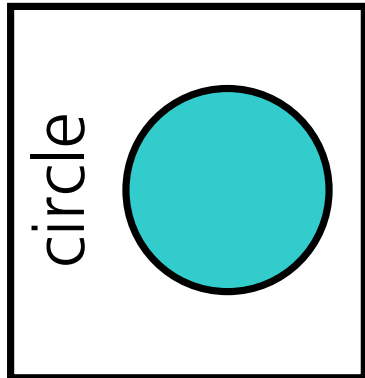
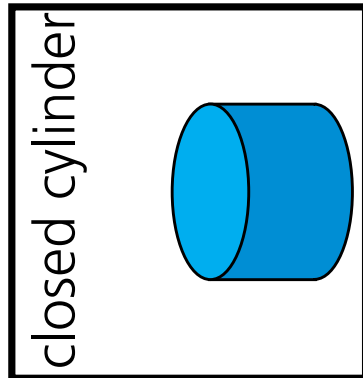
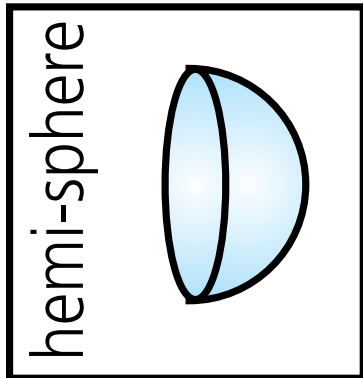
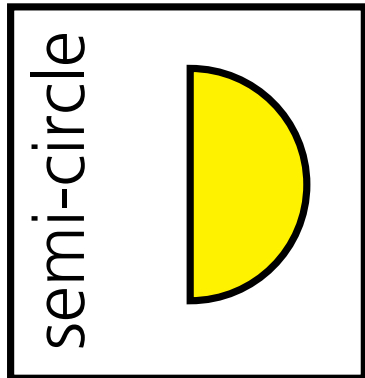
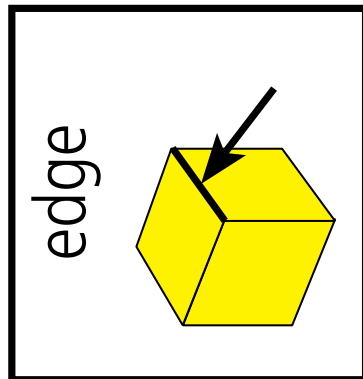
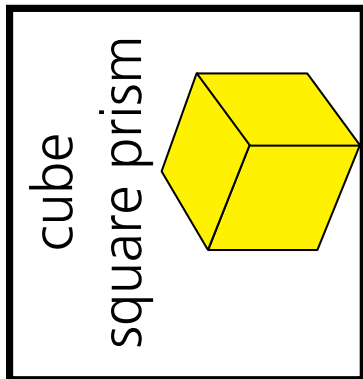
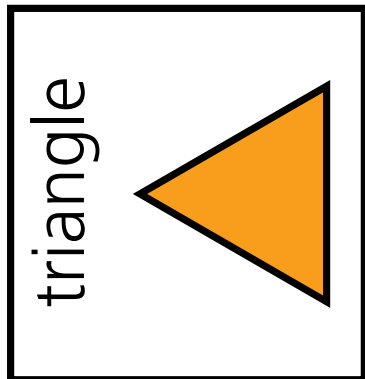
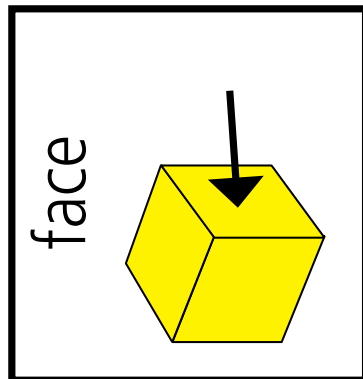
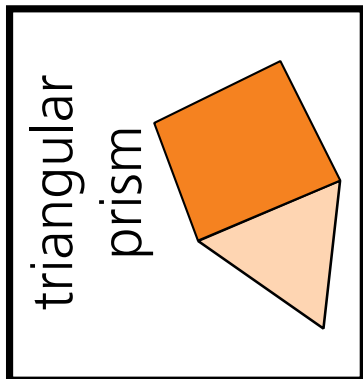
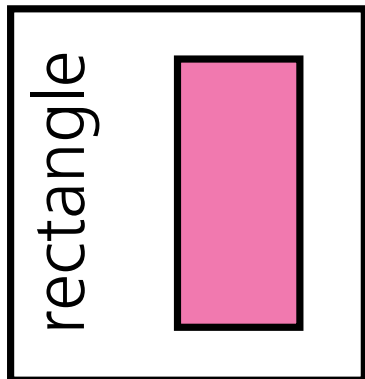
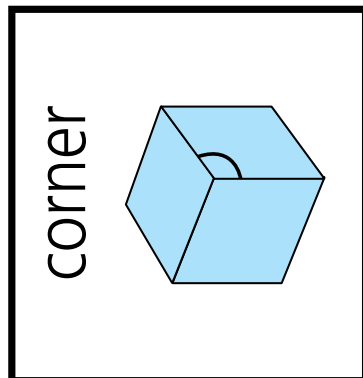
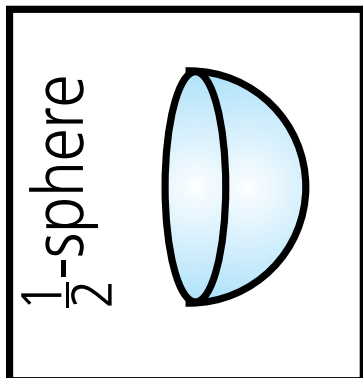
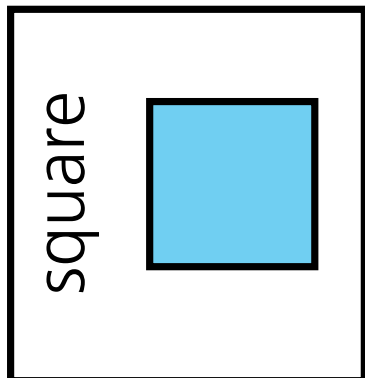



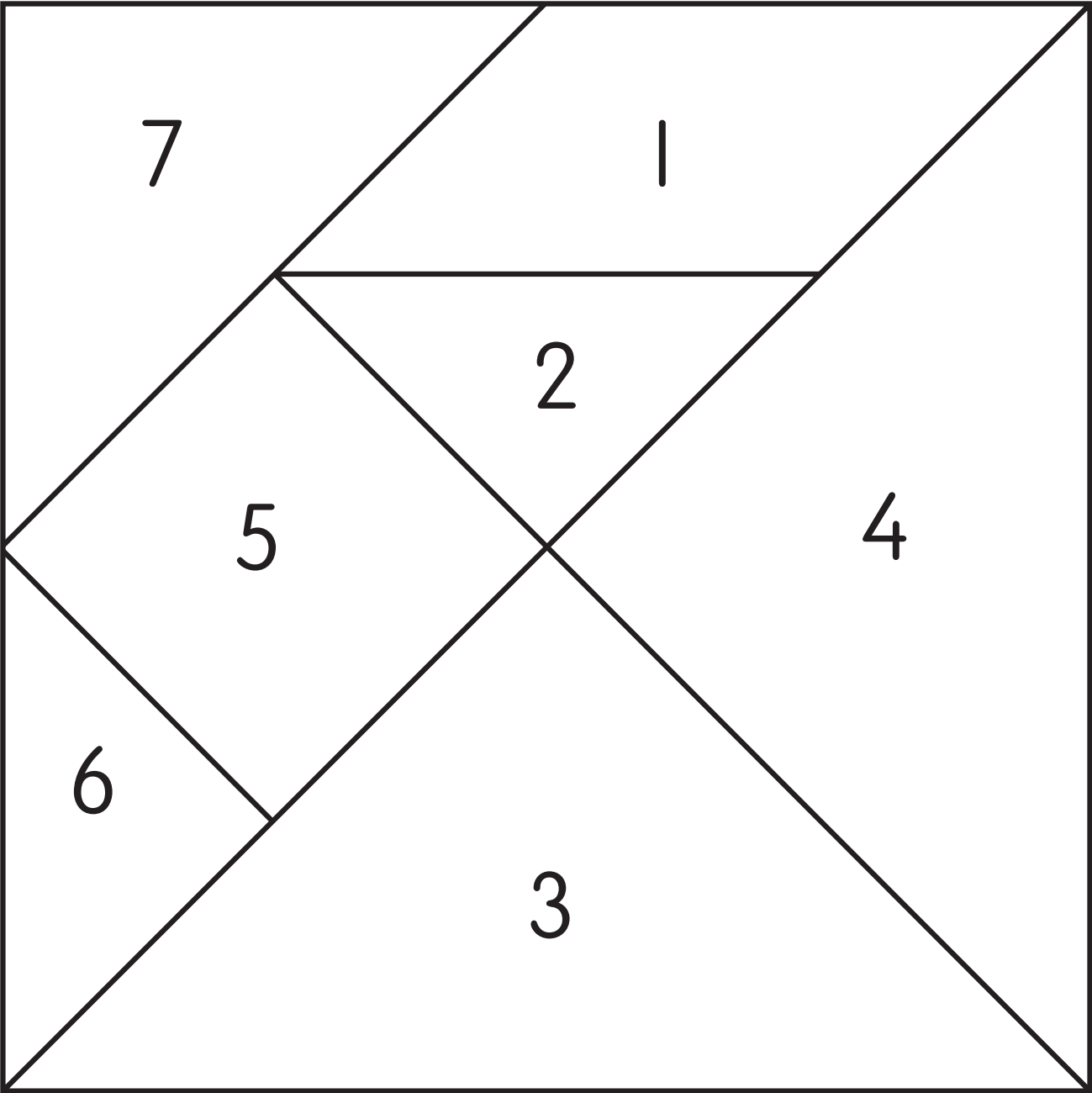

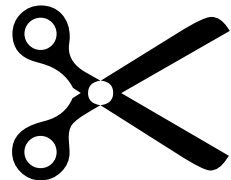
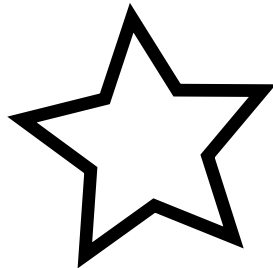
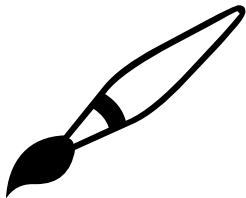
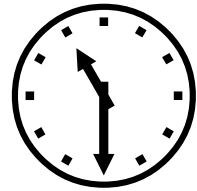
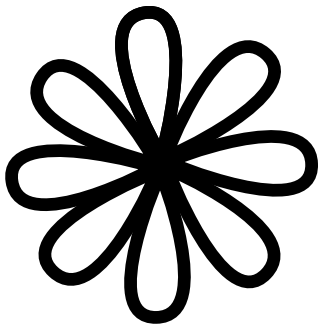
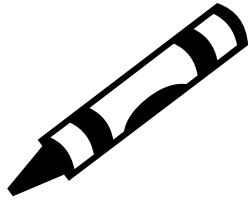





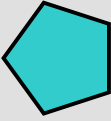



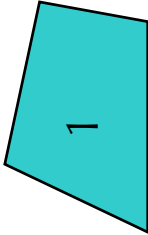
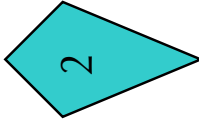

								
Shape								
Number of edges								
Number of corners								













Talk about how these shapes are the same. Talk about how they are different.

Which shapes are rectangles? \_\_\_\_\_

Is shape 2 a rectangle? Why? Why not? \_\_\_\_\_

Finish this sentence: A rectangle is a shape that has \_\_\_\_\_.

Which shapes are 'ordinary rectangles'? \_\_\_\_\_

Which shapes are squares or 'special kinds of rectangles'? \_\_\_\_\_

Finish these sentences:

We call shape 2 a \_\_\_\_\_ because \_\_\_\_\_.

We call shape 4 a \_\_\_\_\_ because \_\_\_\_\_.

Match each net with the 3-D object it folds into. Write the name for each object.

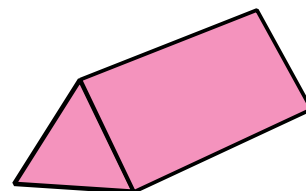
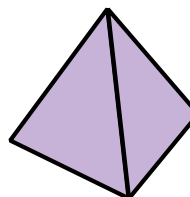
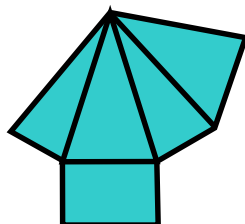
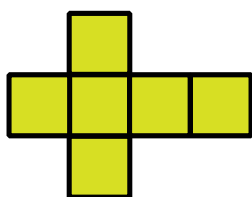
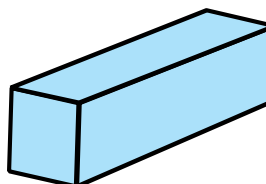
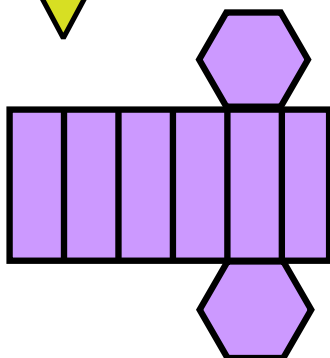
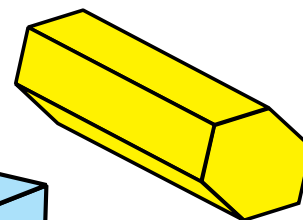
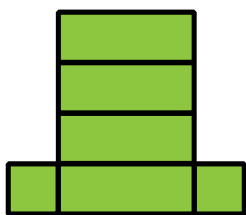
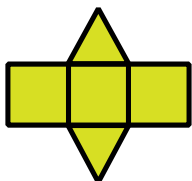
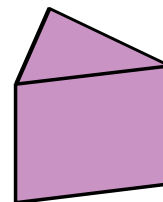
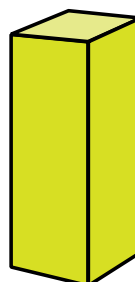
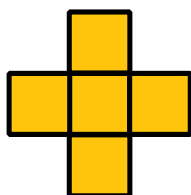
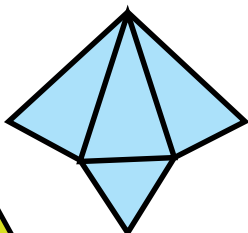
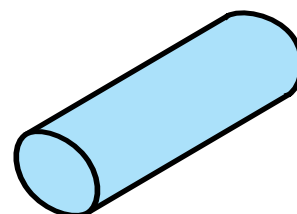
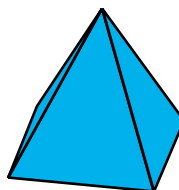
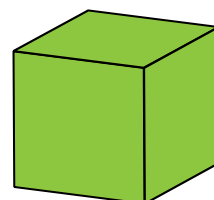
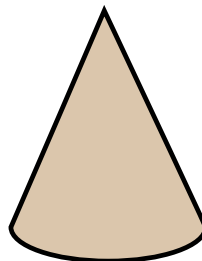
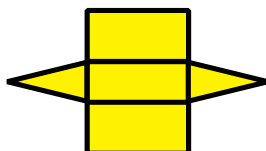
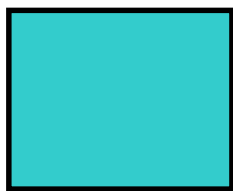
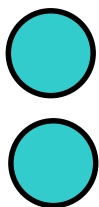
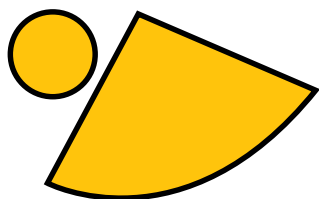
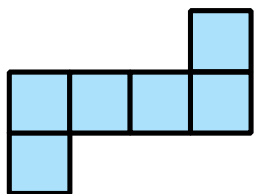

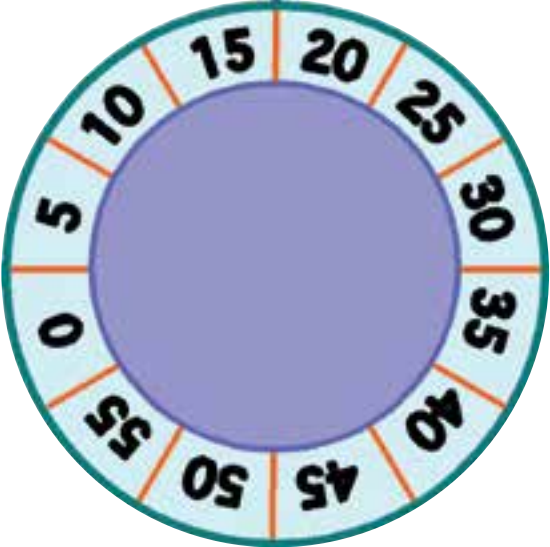
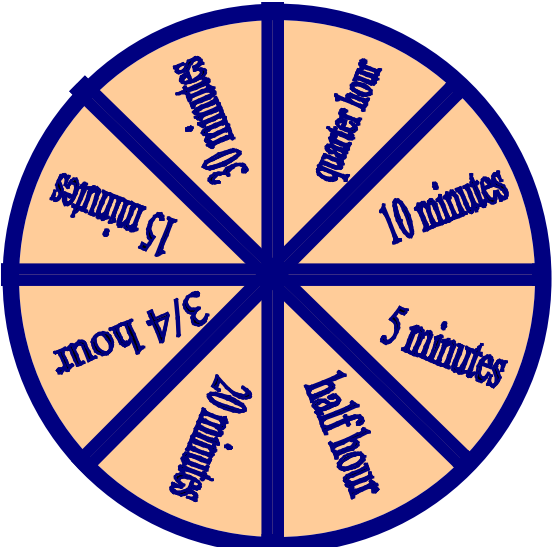
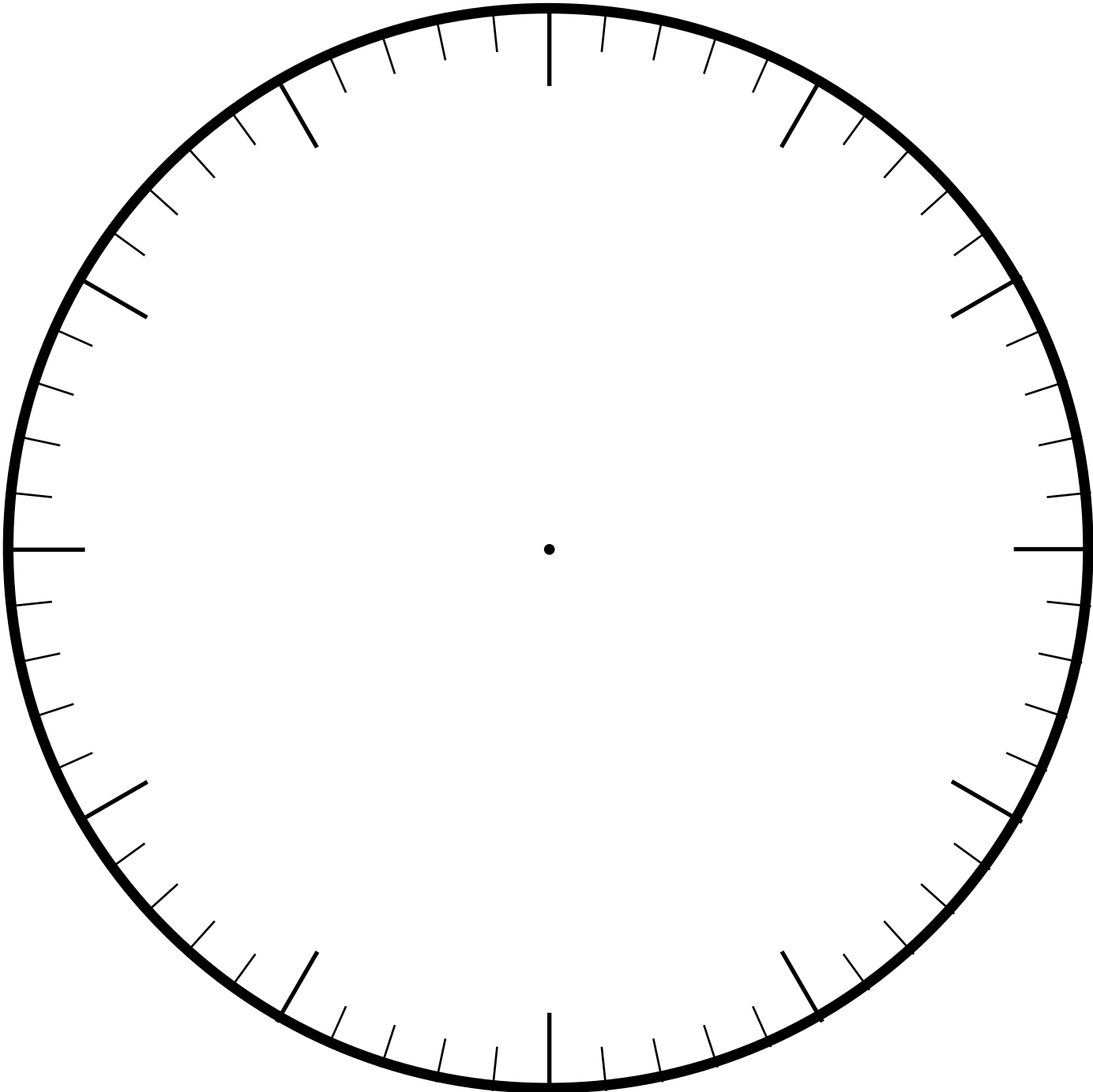

Spinner

**Resources** • Examples of graphs

Concrete object graph

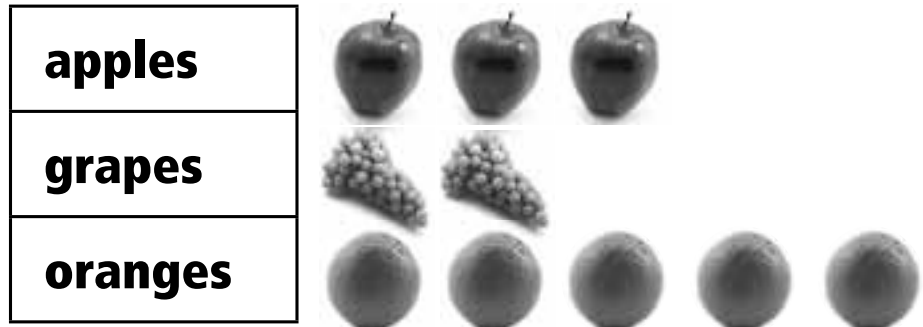

Pictograph

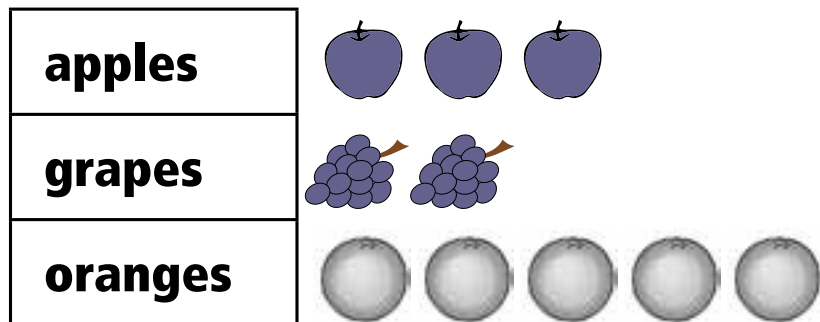

Pictograph

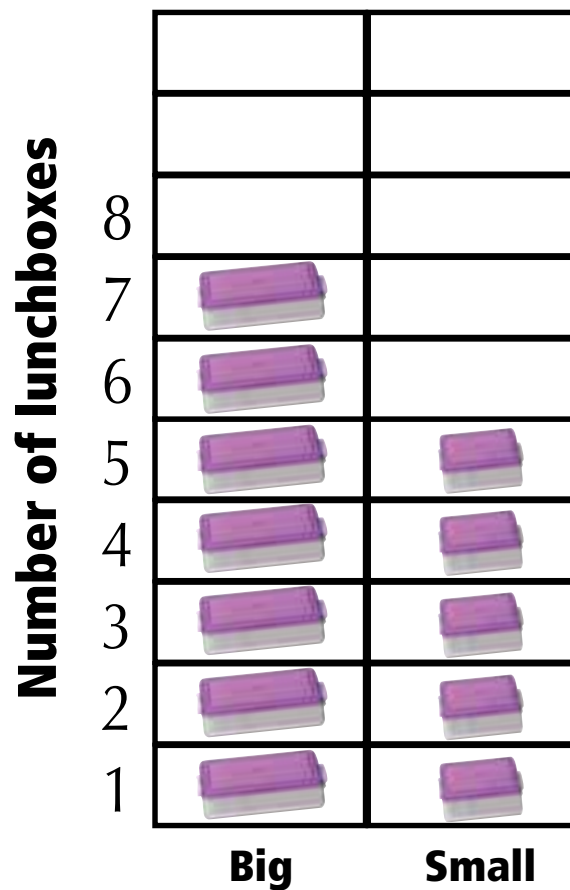



Symbolic graph

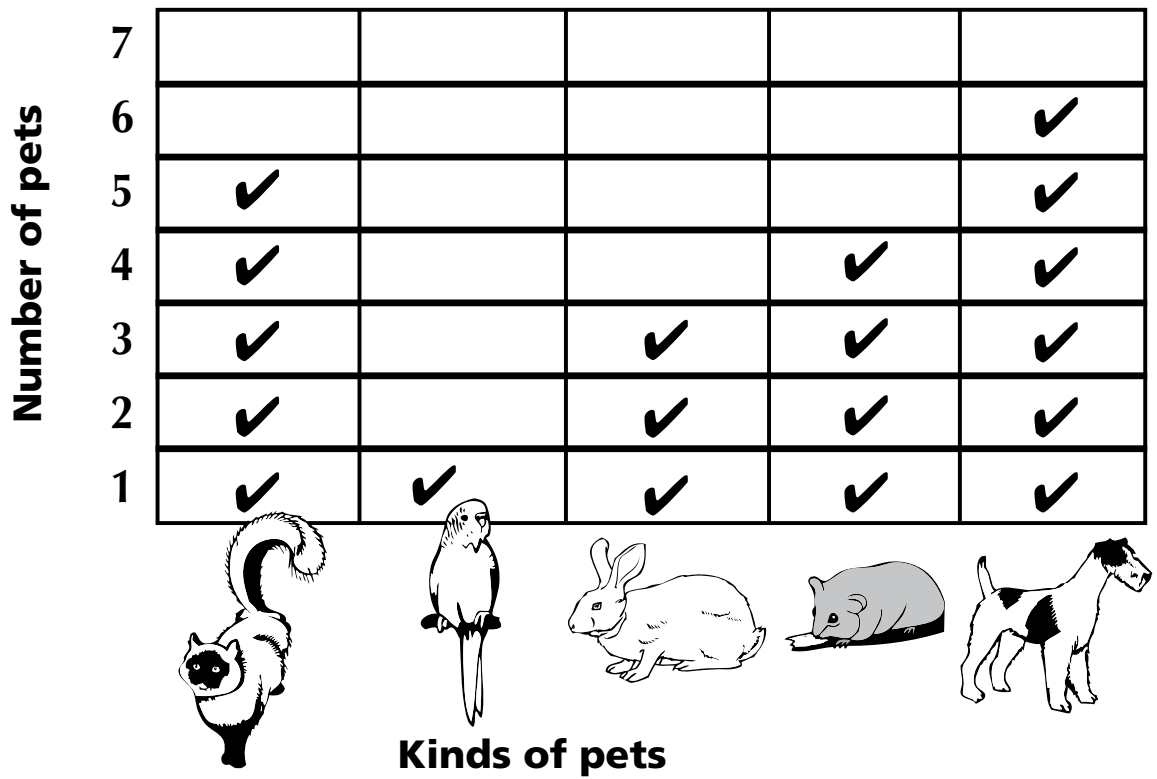

Symbolic graph

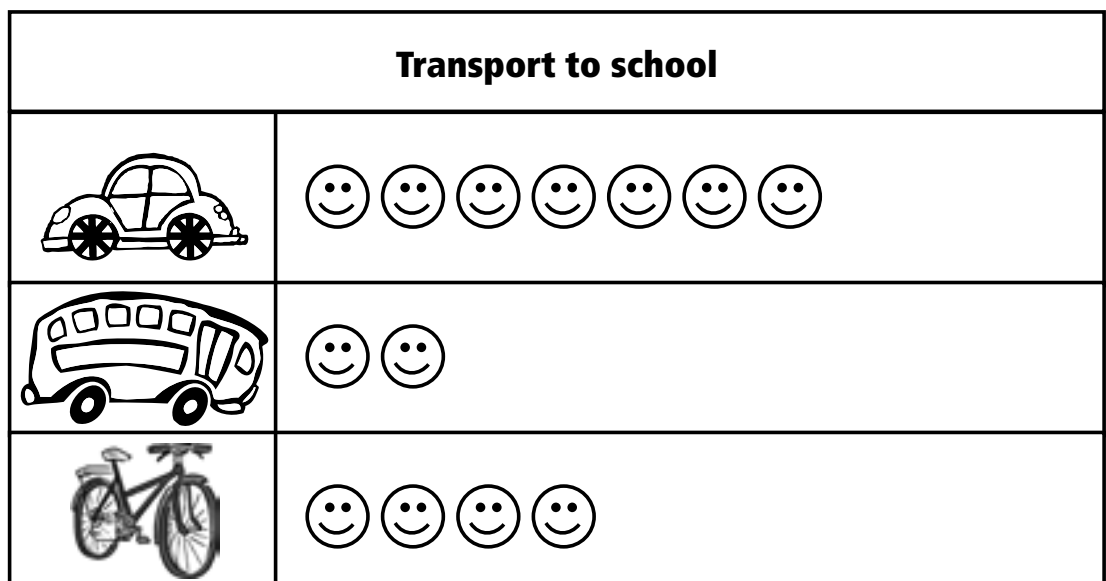

☺ = 1 learner

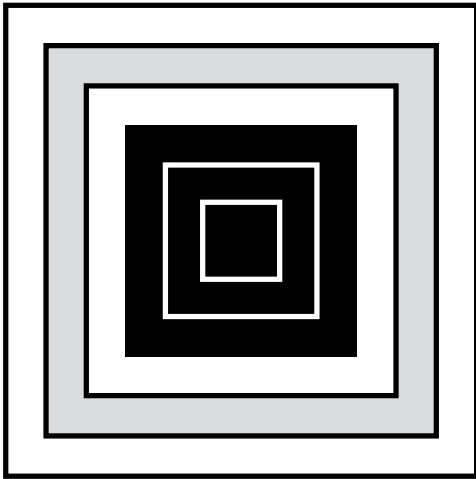

Is there more *grey* or more *black* in the picture, or do they have the same area?

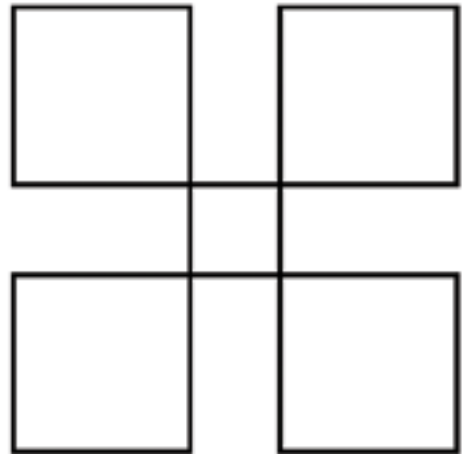
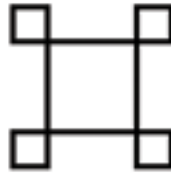

Which of the two inside squares is bigger, or are they the same size?

How many of the grey lines would it take to cover the black line?

How many grey lines would it take to go all the way around the rectangle?

Which line is longer, or are they the same?

Which vertical line is longer, or are they the same?

## South African stars as calendars

- The group of stars that Europeans call the Seven Sisters, or the Pleiades, is a sign in many parts of Africa that the rain is about to begin. Another name for the Pleiades is *isiLimela* which means the 'digging stars', because when they first appear in the sky it is time to begin hoeing the ground. Xhosa men used to count their years of manhood from the time in June when *isiLimela* first became visible. In the language of the Khoikhoi and San the same stars are called *Khuseti* or *Khunuseh* which means rain stars. Their appearance indicates the rainy season is near and a new year is beginning. Because of this the Pleiades are considered friendly. When the Pleiades appear in the east, babies are lifted by their mothers and presented to the stars and the children are taught to stretch their hands toward them. The Sotho call them *Selomela*, and they know that when they rise in the east, there will be frost and the leaves will fall from the trees.
- The bright stars of the pointers and the southern cross are seen as giraffes by many cultures. Among the Venda the giraffes are known as *Thutlwa*, which means 'rising above the trees'. In October the giraffes skim above the trees on the evening horizon, reminding people to finish planting.
- For the Tswana, the stars of Orion's sword are '*dintsa le Dikolobe*', three dogs chasing the three pigs of Orion's belt. Warthogs have their litters while Orion is prominent in the sky – frequently litters of three.
- Other stars tell when certain foods will be ready to eat. The bright star the Europeans call Canopus is called '*ants' egg star*' by some peoples because it appears in the sky when the eggs are ready to eat. The Sotho called the same star *Naka* (the horn), or *E a dishwa* (it is carefully watched). Sotho men used to camp in the mountains, where they made fires and watched the early morning skies in the South, because they believed that the first person to see the star would be very prosperous that year, and would have good luck for the rest of his life. The chief would give the lucky man a heifer. However, if Canopus is seen in May with a very intense light, it means the frost will be very hard.
- Among the Venda, the first person to see the same star, which they call *Nanga*, in the morning sky, climbed a hill and blew a sable antelope horn (*phalaphala*). Among the Mapeli, the first person to see the star would begin ululating loudly enough to be heard in the next village, where everyone would then join the noisemaking to send the news to other villages, each in turn, until all knew Canopus had been seen.
- For Swazi and Zulu skywatchers, *iNqonqoli* or *Ingongoni* (Spica) was a star associated with wildebeest, whose calves were born in the season when the star rose just before the sun and the morning star.
- The Small Magellanic Cloud is a fuzzy object in the sky which astronomers now know is a galaxy, is known as *mo'hora le tlala*, which means 'plenty and famine'. If dry dusty air made it appear dim, there would be famine in the near future.

## Star lore

When a particular star appears along with a certain event, it sometimes looks as if the star is actually causing the event to happen. Many cultures perform rituals to ask the stars to provide what they need, and have created stories of how gods or ancestors were turned into stars.

- The Khoikhoi and the San believe that when rain is accompanied by lightning, girls who are out in the open are struck by the lightning and are turned into stars. Therefore young unmarried women and girls must hide themselves from the rain.
- They say that a girl child of the old people had magical powers so strong that when she looked at a group of fierce lions, they were immediately turned to stars. The largest are now the stars in the Orion's belt.
- A strong-willed girl became so angry when her mother would not give her any of a delicious roasted root

## Resources • South African stars as calendars

that she grabbed the roasting roots from the fire and threw the roots and ashes into the sky, where the red and white roots now glow as red and white stars, and the ashes are the Milky Way.

- According to the Namaquas, the Pleiades were the daughters of the sky god. When their husband shot his arrow at three zebras, it fell short. He dared not return home because he had killed no game, and he dared not retrieve his arrow because of the fierce lion that sat watching the zebras. There he sits still, in the sky, shivering in the cold night and suffering thirst and hunger.
- To Xhosas, the Milky Way seemed like the raised bristles on the back of an angry dog. Sotho and Tswana saw it as *Molalatladi*, the place where lightning rests. It also kept the sky from collapsing, and showed the movement of time. Some said it turned the Sun to the east.

## The sun through the seasons

- The rising point and setting point of the sun moves north and south during the year. The sun reaches its most northern point in June and its most southern point in December. Xhosa call these solstices *injikolanga*, 'the turning back of the sun'. Royal Swazi villages had specialists to observe the sun and determine their exact date. Ceremonies were scheduled according to the astronomer's observations rather than the Western calendar.

## The stars as a calendar

Our ancestors used the stars to tell the date. How?

Do this activity to help learners understand how the annual motion of the earth around the sun causes us to see different stars in different seasons. It should be done outdoors because you want as much space as possible to put the constellations in a very large circle.

Assign one learner to be the sun, who will stand in the centre of the circle. Make 12 large labels with the names of the months on them and place them around the sun in a circle.

They should be arranged clockwise from January through December. This circle represents the path of the earth around the sun during the year.

Make posters with the names and pictures of the constellations of the zodiac. Attach these posters to string. Assign 12 learners to hold up the constellations in as big a circle as possible. Each constellation will hang from the string stretched between 2 learners.

Have one learner stand at the position of the earth in March (at the March label). Ask the learner

- Look at the sun. Which constellation is behind it? (Aquarius)
- Can you see the constellation Aquarius in January? (No because it is in the same part of the sky as the sun so it is in the sky during the daytime.)
- Have the learner rotate clockwise (put his left hand on his chest and turn in the direction of his fingers) until his back is to the sun. What constellation does he now see? (Leo)



- Can we see Leo in March? (Yes, because it is opposite the sun, so it will be highest in the sky at midnight.)
- During the night the stars are rising and setting. We can see all the stars that are in the sky when the sun is not. If we can see the sun we can't see the stars because the sun is so much brighter. Ask the learner to turn to face the sun, and then slowly rotate clockwise, always looking straight ahead. When can he no longer see the sun? Which constellation is the first one he can see after he can no longer see the sun? Ask him to continue naming constellations he can see as he continues to turn until he can once again see the sun.



Zodiac signs

Next ask the learner to move to June and ask the same questions, then to September and December.

Allow other learners to try, and then change roles so that the learners who are holding the constellations and serving as the sun have a chance to be the earth.

The purpose here is to give learners a qualitative sense of why we see different stars at different seasons, and how stars can tell us what season we are in. We are not asking them to remember which constellation they can see in which time of year.

The information in this table is provided only to help you set up the demonstration correctly. It reflects the astronomical path of the sun today. The dates when the sun appears in a given constellation are a little different from the dates used in astrology because the system used by astrologers was developed thousands of years ago and the path of the sun has shifted a little bit since then.

Month	Sun appears in	Constellation opposite the sun
Jan	Sagittarius	Gemini
Feb	Capricorn	Cancer
Mar	Aquarius	Leo
Apr	Pisces	Virgo
May	Aries	Libra
June	Taurus	Scorpio
July	Gemini	Sagittarius
Aug	Cancer	Capricorn
Sep	Leo	Aquarius
Oct	Virgo	Pisces
Nov	Libra	Aries
Dec	Scorpio	Taurus

## Eureka!

Have you ever heard of an “absent-minded professor”? To be a great thinker you have to concentrate and focus on a problem, and not be distracted by other things. In fact, sometimes, some especially good thinkers get so interested in an idea they are working on that they forget about some of the ordinary things that everyone else remembers.

*Archimedes was a mathematician who lived more than 2 000 years ago in a Greek city called Syracuse. Because he was a very good thinker, his king, King Hiero, often asked Archimedes for help.*

*Once King Hiero gave a goldsmith (someone who makes things out of gold) a lot of pure gold to make him a crown. The goldsmith took the gold and brought back a beautiful crown in the shape of a ring of delicate*





## Resources • Archimedes

gold leaves. The crown was finely made and beautiful. King Heiro saw that the goldsmith was a skilful artist. But was he honest? The king weighed the crown and saw that it was the same weight as the gold he had given to the goldsmith. But still he wasn't sure. Was the crown really solid gold, or could the goldsmith have kept some of the gold and secretly replaced it with an equal weight of some less expensive metal, like silver, in his crown?

The King's advisors told him the only way to be sure would be to melt down the crown and see if it was all gold, or if there was something else mixed in. He thought that was a terrible idea. So he asked Archimedes if he could think of another way to find out.

Archimedes wanted to help King Heiro, so he started to think about it. When Archimedes was thinking about an interesting maths problem he put his whole mind into it. Sometimes he liked to think about things in the bath. That night when he filled up his bathtub he was thinking about the king's crown, so he didn't notice that he filled the bathtub to the very top. When he got in water spilled out and went all over the floor.

Now an ordinary man might have been annoyed at this, and would surely have stopped his day dreaming to clean up the spilled water, but not Archimedes. He was a thinker. He thought, "What makes the water spill out when I get into the tub? Of course, I am taking up some of the room that the water was taking up. So the water has to get out of the way to make room for me. So, exactly how much water has to spill out? The water that spills out will take up exactly the same amount of space as the part of my body that's under water."

"Eureka!" Archimedes said to himself. Eureka is a Greek word that means "I have found it." He said 'Eureka' because he had found the solution to the problem of the king's crown. They knew the crown had the same weight as the gold the king had given to the goldsmith. But Archimedes had just discovered a way to measure the crown's volume, without harming the crown. If he put the crown in a bowl filled to the top with water and measured how much water spilled over he would know exactly how much space the crown took up. If it was made of pure gold, it should have exactly the same volume as the gold the king had given the goldsmith. If it wasn't pure gold, more water would spill out because other metals, like silver, take up more space for the same weight.

Archimedes was thrilled that he had solved the king's problem. He dashed out the door to run to tell the king. He ran down the streets of Syracuse shouting "Eureka!" (I have found it!).

It was truly a great moment in the history of maths. And a funny moment, too, because Archimedes was so excited about his discovery that he had forgotten to put his clothes on!

Archimedes arrived to tell the king the good news. The king was pleased and asked Archimedes to test the crown – after he put on some clothes!

First he put the exact number of gold pieces the king had given to the



A real gold crown of leaves made in Syracuse about the time that Archimedes lived.

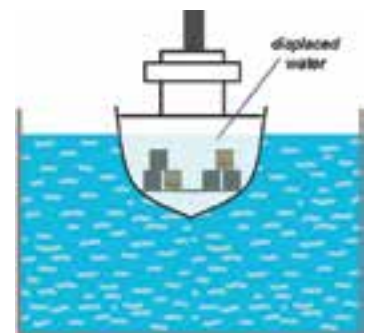



*goldsmith into a bowl full of water to see how much overflowed. Then he took out the gold and put in the crown. If the crown was made of pure gold it would take up exactly the same amount of space as the gold pieces and the water would just reach the rim. But each gram of silver takes up almost twice as much space as gram of gold. So, if some of the gold had been switched for the same weight of silver more water would overflow. And it did!*

*The naughty goldsmith had to give back the gold he had stolen from the king, and for the rest of Archimedes' life the king called on him for help with many different kinds of problems. In his lifetime Archimedes was famous amongst his neighbours for being an 'absent minded professor' – concentrating so much on his ideas that he often forgot to pay attention to the ordinary things like eating and sleeping, and once even forgetting to put on clothes before going to see the king. Today he is remembered as a brilliant inventor and a genius in mathematics, science and engineering. Archimedes' good concentration made him one of the greatest thinkers ever.*

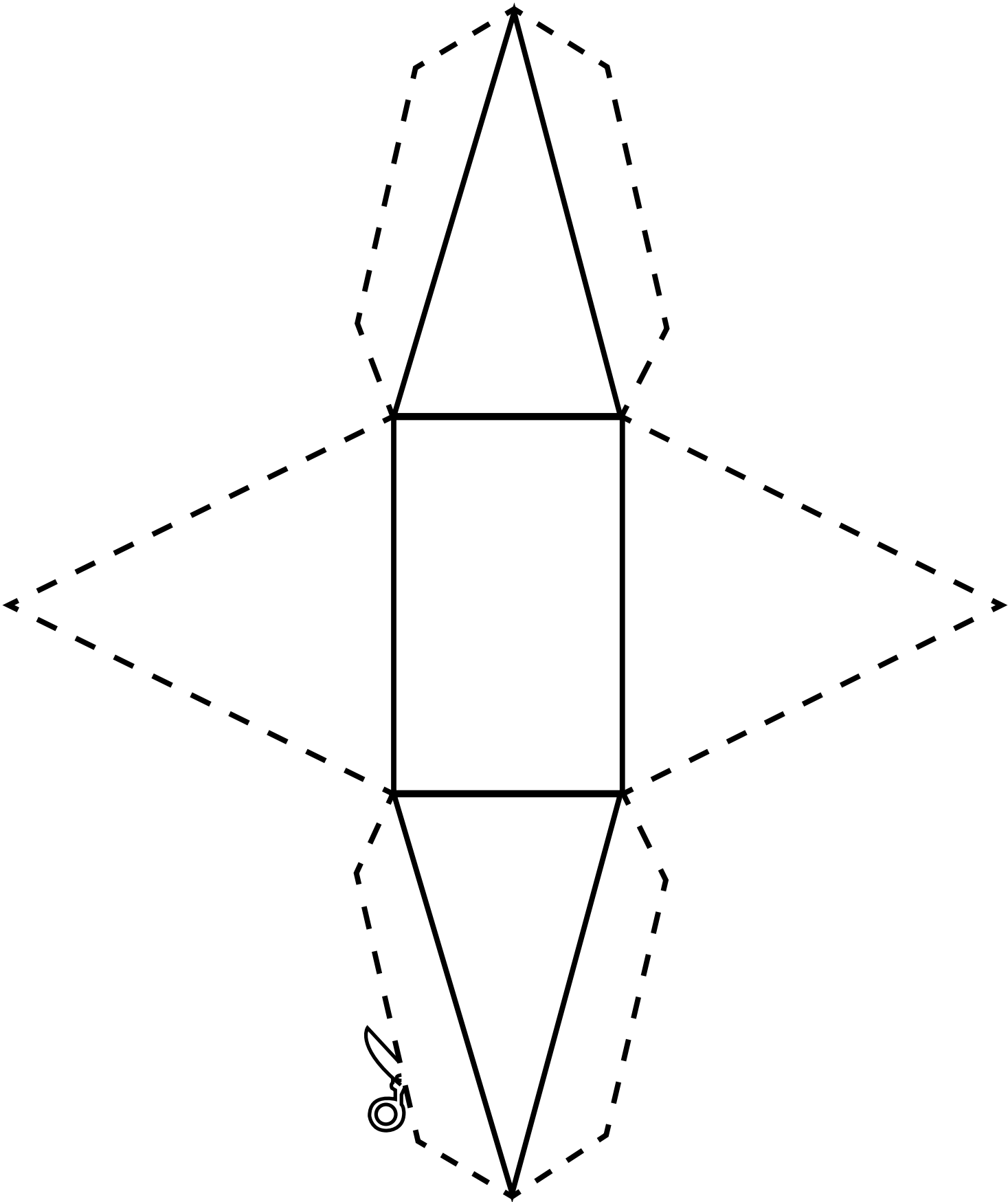

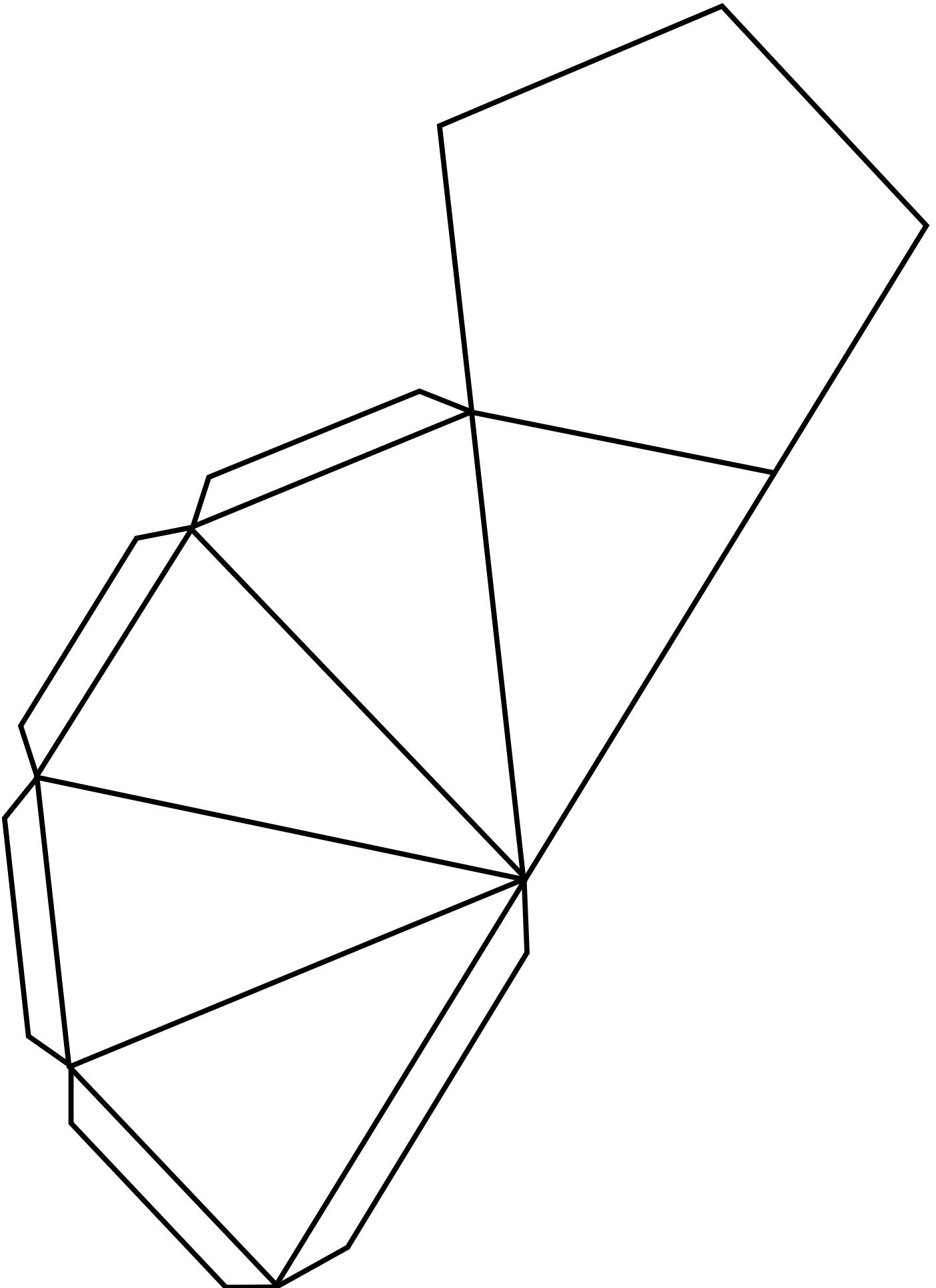

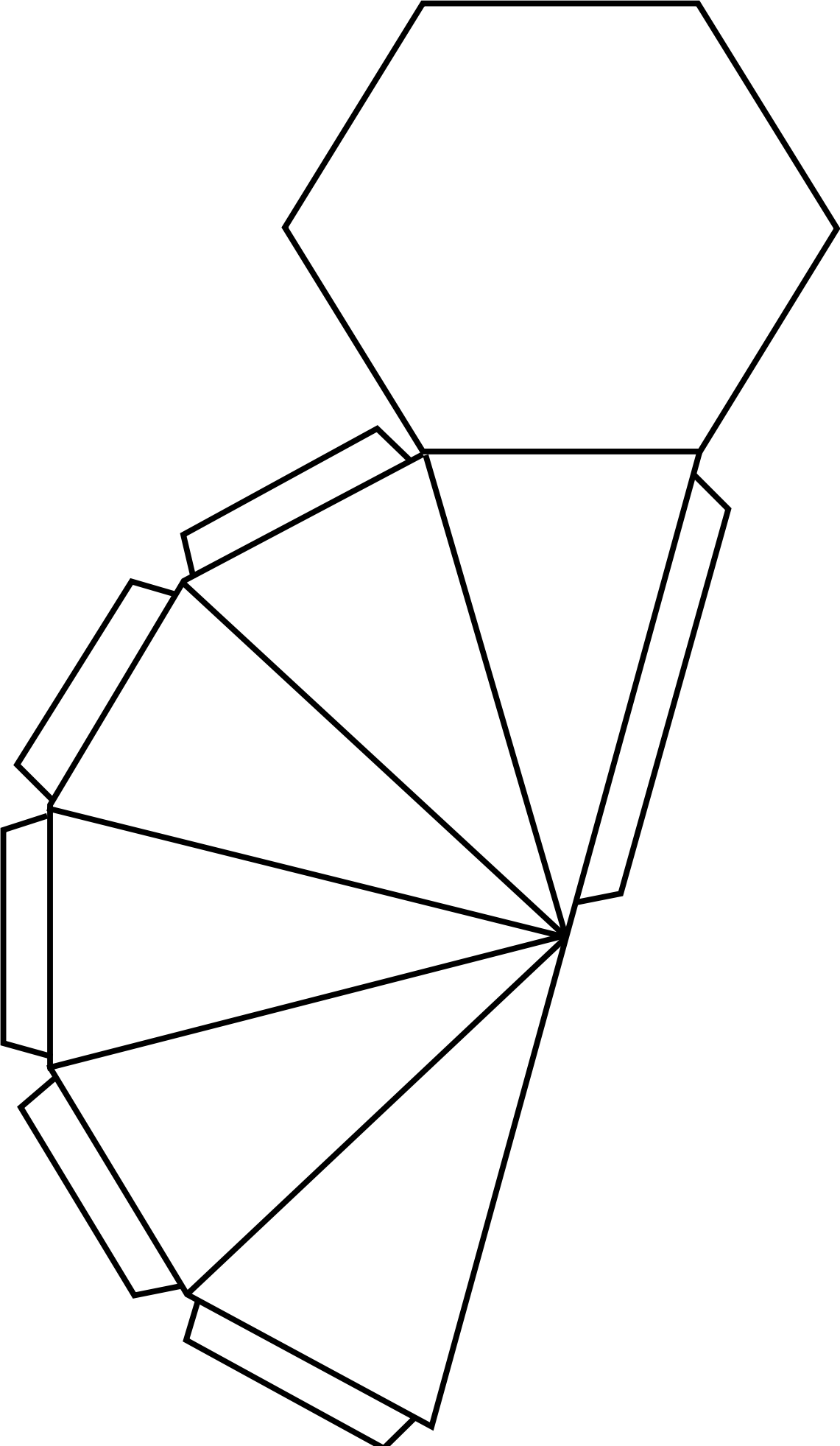







$12+5=17$   $10 \times 10=100$   $50-25=25$   $10+2=12$   $2+2=4$

GUIDELINES FOR TEACHING  
**NUMERACY**  
FOUNDATION PHASE

$12+5=17$   $10 \times 10=100$   $50-25=25$   $10+2=12$   $2+2=4$